

FOAM BOARD	1
GLASS, ACRYLIC, MIRROR	5
TAPES, ADHESIVES, & MOUNTING SUPPLIES	9
CONSERVATION TAPES, ADHESIVES	12
MOUNTING TISSUES & ADHESIVE RELEASE BOARDS	14
GLUE & ADHESIVES	17
WIRE PRODUCTS	19
BLADES - MAT CUTTING & GENERAL USE	21
V-NAILS	23
JOINING, POINT DRIVERS, STAPLERS & POINTS	24
PICTURE HANGING HARDWARE & FASTENERS	27
TOUCH-UP & FILLERS	36
FITTING & BACKING SUPPLIES	38
MOUNTING & HANGING SUPPLIES	40
SPECIALTY TOOLS & CLEANING ITEMS	42
KRAFT PAPER & DISPENSERS	46
GALLERY HANGING & DISPLAY PRODUCTS	47
PACKING MATERIALS & SUPPLIES	48
STRETCHER BARS	50
EDUCATIONAL MEDIA	51
MACHINERY	53
MATBOARD	71
INDEX	109

Terms of Sale

TERMS:

- Net 15 days.
- Prices were correct at the time this catalog was printed and subject to change without notice.
- Questions concerning your orders should be addressed to us in writing within 10 days of receipt of order.
- All past due accounts will be shipped C.O.D.
- Shipper's C.O.D. charge will be added to all C.O.D shipments.
- Interest charges of 1.5% will be added to all past due accounts.
- There is a \$30.00 charge on all NSF checks.
- In the event of default of payment, the customer shall pay for all costs of collection, including but not limited to, attorney's fees, court costs, and collection agency fees.

CREDIT:

- To open your account, please complete our credit application with three trade references and your bank information. Allow 2 to 4 weeks processing to establish an approved credit line. Incomplete credit applications will delay establishment of credit line. Until credit is approved, a check must accompany the order or, with your approval, we will ship C.O.D.

REMITTANCE:

- Please write your account number and invoice numbers on your check and return with the remittance copy of your invoice.

SHIPMENTS:

- F.O.B., our warehouse. Shipments will be made by manner requested. If specific instructions are not given, we will use our discretion.
- FedEx weight and size limitations (*subject to additional handling fees*):
- Packages can be up to 165" in COMBINED length and girth.
- Packages can be 108" in length
- Packages can be up to 150 lbs.
- Packages that exceed 70 lbs. are subject to additional FedEx handling charge.
- Packages with a large size to weight ratio require special pricing using dimensional weight calculations.
- Packages that exceed FedEx weight and size limits are subject to additional FedEx charges.
- Any package exceeding 48" will incur an additional \$12.00 handling fee.

RETURNS:

- No returns will be accepted without prior authorization from an Omega customer service representative.
- A return merchandise authorization (RMA) number will be assigned to you to facilitate the processing of your return.
- Any merchandise being returned that is not defective or due to our error must be returned freight prepaid by the customer, and will incur a restocking fee of 15% of the item price.
- No returns will be authorized after 30 days from receipt of goods.

DAMAGES:

We are not liable for loss or damage by carrier. In the event of damage, save the merchandise and original packaging so that a proper claim can be filed. Note external carton damage or box shortage on the carrier bill of lading or FedEx receipt before signing. Truck and FedEx claims must be filed by OMEGA.

OMEGA LOCAL TRUCK DELIVERY AREA:

Call your Omega sales representative for local delivery details for the distribution facility in your area.

- All orders under \$100.00 incur a \$9.95 delivery charge.
- All local deliveries incur the current fuel surcharge.
- If your delivery falls on a holiday, your order will be delivered the same day the following week.
- Please allow at least 48 hours for order processing for all local deliveries.





Omega Moulding is a national wholesaler of fine quality picture framing products. We have been providing mouldings of outstanding craftsmanship since 1968. Omega maintains state of the art distribution centers throughout North America in New York, Los Angeles, San Francisco, Atlanta, Chicago, and Toronto. Each facility is stocked with the entire line of over 1400 high quality mouldings available in Length, Chop and Join options. In addition to quality mouldings, Omega offers the largest selection of premium quality Plein Air Gallery Frames in the business, Digital printing machines and consumables, as well as our full line of framing supplies and instructional media for the picture framing industry.

Quality

The products in this catalog have been selected based on over 75 years of combined business experience between Omega Moulding Company and M&M Framing Supplies, acquired by Omega in 2013. These products have been tested for quality and the suppliers represented in this catalog have been vetted for their reliability and integrity. The framing hardware items sold in this catalog are manufactured using the best quality metals and the highest quality surface plating.

Pricing

Pricing in this catalog was accurate at the time of printing. Since there are more than 100 different manufacturers represented and many change their pricing at various times of the year, it is BEST to check our constantly updated online catalog for up-to-date pricing.

Availability

Availability of some items may be restricted to certain geographic areas by the manufacturer. If the product you wish to buy is not offered in your state we will be happy to suggest a comparable alternative from a different manufacturer.

Online Ordering

Please be sure to visit the Omega Moulding website at www.omegamoulding.com where, as a customer, you can register and instantly use the website as a tool for your business. You can review and select from the complete Omega line, check pricing, view specials, download updated pricing documents, browse closeouts, view your discontinued samples, and use all of the resources we have available to make working with Omega as convenient as possible.

Another great benefit of the Omega Moulding website is online ordering. Convenient, easy-to-use and ready at your fingertips 24 hours a day, you can place orders after hours to ensure that you and your customers will receive your items as quickly as possible.

Ride-Along Program

To make buying your Chops and Framing Supply Items a convenient one-stop shopping experience, we have created the following **Free Freight Program** for you:

- **Supplies accompanying Chop orders of \$75 qualify for Free Fed Ex ground:**

Your entire order including Framing Supplies will ship free freight when your chop order is valued at \$75 or more.

**Oversize items, mats, glass products, foam board, Kraft paper, cardboard corners and gallons of glue are excluded from the free freight ride along due to their bulk and competitive commodity pricing.*

...and remember "Three and it's Free"; Order three chops and we ship your order for free!

- **Ride-Along for Length**

The cost difference of adding 10 pounds of Framing Supplies to **RIDE-ALONG** with a Fed Ex length order will only increase the cost of the freight between \$1.50 and \$3.00 depending on your zone.

Buy More & Save More! Supplies & Moulding together adds up to savings!

In addition to the Ride-Along program you are welcome to use the promo code **SC14** and any time you order more than \$350 in supplies you can receive an additional 5% off your length, chop or join order.

**Orders with special volume pricing are excluded. Cannot be combined with other promo codes.*

Save on Supplies with Gallery Frames!

- **Order \$500 in frames, & get 5% off all accompanying supplies. Use Promo Code **GS14****

Omega offers an extensive line of Plein Air style and traditional finished corner Gallery Frames.

Our frames are hand crafted and provide the best quality/price in the industry.

Visit our website to view our Gallery Frames at www.omegamoulding.com/Classic/Gallery.htm, or request a catalog.

ENCORE™

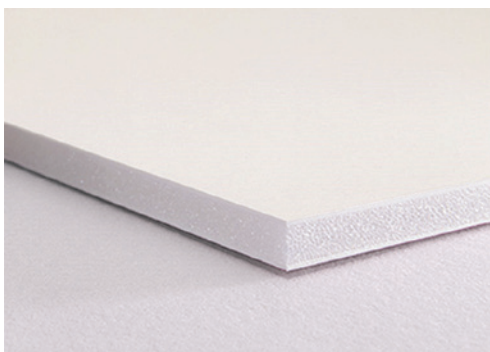

Encore FoamBoard products feature double clay-coat paper surfaces with an ultra-smooth finish and tough-yet-pliable polystyrene cores. Practically weightless, Encore Foam Boards are great for a wide variety of picture framing applications. Encore boards feature a resilient polystyrene memory core that “bounces back” after handling, cutting or mounting.

ENCORE White Foam Board

Smooth white clay coat board with resilient memory core.

Item #	Size	Per Sheet	1 Box Price	4 Boxes	8 + Boxes
RFB2436	3/16" 24 x 36	1-24 Sheets: \$ 3.26	25/box: \$ 49.88	\$ 47.51 ea.	\$ 44.89 ea.
TFB3240	1/8" 32 x 40	1-24 Sheets: \$ 4.58	25/box: \$ 68.51	\$ 65.10 ea.	\$ 61.69 ea.
RFB3040	3/16" 30 x 40	1-24 Sheets: \$ 4.92	25/box: \$ 75.08	\$ 71.40 ea.	\$ 67.46 ea.
RFB3240	3/16" 32 x 40	1-24 Sheets: \$ 4.58	25/box: \$ 68.51	\$ 65.10 ea.	\$ 61.69 ea.
TFB4060	1/8" 40 x 60	1-24 Sheets: \$ 8.62	25/box: \$130.20	\$123.38 ea.	\$116.81ea.
RFB4060	3/16" 40 x 60	1-24 Sheets: \$ 8.62	25/box: \$130.20	\$123.38 ea.	\$116.81ea.
TFB4896	1/8" 48 x 96	1-24 Sheets: \$21.78	25/box: \$347.29	\$329.96 ea.	\$312.90 ea.
RFB4896	3/16" 48 x 96	1-24 Sheets: \$17.67	25/box: \$265.13	\$252.00 ea.	\$238.61 ea.
RFB6096	3/16" 60 x 96	1-19 Sheets: \$40.62	20/box: \$361.20	\$343.14 ea.	\$325.29 ea.
8000SA	1/2" 30 x 40	1-24 Sheets: \$11.58	25/box: \$192.15	\$182.44 ea.	\$172.73 ea.
8000ST	1/2" 40 x 60	1-11 Sheets: \$23.40	12/box: \$186.86	\$177.41 ea.	\$168.21 ea.
RFB24896	1/2" 48 x 96	1-11 Sheets: \$43.58	12/box: \$321.68	\$305.68 ea.	\$289.42 ea.

ENCORE Bright White Acid-Free Foam Board

The same archival qualities as Acid-Free Cream, but with bright white acid-free facing papers that create a premium imaging surface for framing projects requiring the whitest substrate. The higher perceived whiteness enhances the maximum color gamut and black density of printed images.

Item #	Size	Per Sheet	1 Box Price	4 Boxes	8 + Boxes
WAF3240	1/8" 32 x 40	1-24 Sheets: \$ 7.14	25/box: \$107.10	\$101.59 ea.	\$ 96.60 ea.
WAF3240	3/16" 32 x 40	1-24 Sheets: \$ 7.14	25/box: \$107.10	\$101.59 ea.	\$ 96.60 ea.
WAF4060	1/8" 40 x 60	1-24 Sheets: \$12.66	25/box: \$189.79	\$180.60 ea.	\$170.89 ea.
WAF4060	3/16" 40 x 60	1-24 Sheets: \$12.66	25/box: \$189.79	\$180.60 ea.	\$170.89 ea.

ENCORE White 100% Cotton Rag Foam Board

Constructed with pure, naturally white cotton fibers, each facing paper has a pH of 8.2 +/- .5 and a calcium carbonate buffer. Contains no lignin, alum or harsh chemicals.

Item #	Size	Per Sheet	1 Box Price	4 Boxes	8 + Boxes
CRFB3240	3/16" 32 x 40	1-24 Sheets: \$11.42	25/box: \$170.10	\$161.44 ea.	\$153.04 ea.
CRFB4060	3/16" 40 x 60	1-24 Sheets: \$21.32	25/box: \$328.91	\$312.38 ea.	\$295.84 ea.

ENCORE Heat-Activated SingleStep Foam Board

Pre-coated pH neutral foam board with heat activated adhesive. Activates at a low 180-degree temperature. A favorite and industry standard for mounting performance and reliability. *Not recommended for resin coated (RC) photographs*

Item #	Size	Per Sheet	1 Box Price	4 Boxes	8 + Boxes
SFB2436	3/16" 24 x 36	1-24 Sheets: \$ 6.63	25/box: \$ 99.49	\$ 94.50 ea.	\$ 89.51 ea.
SFTB3240	1/8" 32 x 40	1-24 Sheets: \$ 8.38	25/box: \$125.74	\$119.44 ea.	\$113.14 ea.
SFB3240	3/16" 32 x 40	1-24 Sheets: \$ 8.38	25/box: \$125.74	\$119.44 ea.	\$113.14 ea.
SFB4060	3/16" 40 x 60	1-24 Sheets: \$15.00	25/box: \$224.96	\$213.94 ea.	\$202.65 ea.
SFB4896	3/16" 48 x 96	1-24 Sheets: \$29.52	25/box: \$442.58	\$420.53 ea.	\$398.48 ea.

ENCORE Pressure Sensitive Foam Board

Convenient, all-purpose Foam Board features a pressure-sensitive adhesive coating on one side. Simply peel back the protective liner, roll down your image and smooth from the center to the edges for an easy finish without glues or sprays.

Item #	Size	Per Sheet	1 Box Price	4 Boxes	8 + Boxes
PSF2436	3/16" 24 x 36	1-24 Sheets: \$10.34	25/box: \$155.14	\$147.53 ea.	\$139.39 ea.
PSF3240	3/16" 32 x 40	1-24 Sheets: \$15.08	25/box: \$226.01	\$214.73 ea.	\$203.44 ea.
PSF4060	3/16" 40 x 60	1-24 Sheets: \$28.20	25/box: \$406.35	\$385.88 ea.	\$367.50 ea.

ENCORE MightyCore

When you need a durable, extra-strong performer, Encore® MightyCore® is your best bet. The ultra smooth surface provides excellent adherence. The rigid, rock-solid center makes it especially suitable for large fabricated pieces. The construction of MightyCore helps prevent warping, bowing and twisting and creates a “no preparation” surface for mounting and applications that need a rigid substrate.

Item #	Size	Per Sheet	1 Box Price	4 Boxes
M143240	1/4" 32 x 40	1 - 24 Sheets: \$13.85	25 per box: \$316.58	\$301.09 ea.
M144060	1/4" 40 x 60	1 - 24 Sheets: \$25.84	25 per box: \$590.36	\$560.96 ea.
M144896	1/4" 48 x 96	1 - 11 Sheets: \$47.86	12 per box: \$524.54	\$498.33 ea.
M124060	1/2" 40 x 60	1 - 19 Sheets: \$33.55	20 per box: \$613.41	\$582.75 ea.
M124896	1/2" 48 x 96	1 - 11 Sheets: \$60.86	12 per box: \$667.30	\$633.91 ea.

ENCORE (Cream) Acid-Free Foam Board

The professional framer's first choice for a mounting board that's totally acid-free. This product features facing paper with a pH between 7.7 and 8.5. Made with a calcium carbonate buffer that provides many years of protection against pollutants that cause paper to become brittle or yellow with age.

Item #	Size	Per Sheet	1 Box Price	4 Boxes	8 + Boxes
AFTB3240	1/8" 32 x 40	1-24 Sheets: \$ 7.27	25/box: \$112.35	\$106.84 ea.	\$101.06 ea.
AFB3240	3/16" 32 x 40	1-24 Sheets: \$ 7.27	25/box: \$112.35	\$106.84 ea.	\$101.06 ea.
AFTB4060	1/8" 40 x 60	1-24 Sheets: \$12.97	25/box: \$203.96	\$193.73 ea.	\$183.49 ea.
AFB4060	3/16" 40 x 60	1-24 Sheets: \$12.97	25/box: \$203.96	\$193.73 ea.	\$183.49 ea.
AFB4896	3/16" 48 x 96	1-24 Sheets: \$24.94	25/box: \$390.34	\$370.65 ea.	\$351.49 ea.

ENCORE Black-on-Black Acid-Free Foam Board

Featuring the deepest, richest, black paper and foam available, Encore® Black-On-Black® Foam Board delivers a striking performance with dramatic results. Front to back and edge to edge, Black-On-Black Foam Board remains smooth, flawless and solid black through the core.

Item #	Size	Per Sheet	1 Box Price	4 Boxes	8 + Boxes
BBFB3240	3/16" 32 x 40	1-24 Sheets: \$ 8.30	25/box: \$128.10	\$121.80 ea.	\$115.50 ea.
BBFB4060	3/16" 40 x 60	1-24 Sheets: \$15.37	25/box: \$238.09	\$226.01 ea.	\$214.20 ea.
8000K	3/16" 48 x 96	1-24 Sheets: \$31.54	25/box: \$448.09	\$425.78 ea.	\$403.46 ea.
8001D	1/2" 48 x 96	1-11 Sheets: \$58.03	12/box: \$440.87	\$418.82 ea.	\$396.77 ea.

KOOL TACK *The Original 20-Second Drymount Foam Board!*

Regular Foam Board

Kool Tack Regular is the most popular low-temp drymount foamboard. Drymount at 150°F to 160°F in 15 to 20 seconds. Safe for most types of photos, posters and prints. Kool Tack is fully reversible and reusable. The adhesive is pH neutral, smooth and non tacky.

Item #	Size	1 Sheet	1 Box/25sheets	2 Boxes
KT3240	32x40 (3/16")	\$ 9.98	\$149.63	\$141.49
KT3240T	32x40 (1/8")	\$ 9.98	\$149.63	\$141.49
KT4060	40x60 (3/16")	\$ 18.30	\$274.58	\$261.98
KT4896	48x96 (3/16)	\$ 34.23	\$639.45	\$627.64

Kool Tack Black Foam Board

Kool Tack Black Foam Board has the same properties as Kool Tack Regular, but with a black substrate and core. Drymount at 150°F to 160°F in 15 to 20 seconds. Kool Tack Black Foam Board is fully reversible and reusable. The adhesive is also pH neutral, smooth and non tacky.

Item #	Size	1 Sheet	1 Box/25sheets	2 Boxes
KTB3240	32x40 (3/16")	\$ 13.88	\$208.16	\$203.70
KTB4060	40x60 (3/16")	\$ 25.75	\$386.14	\$378.79
KTB4896	48x96 (3/16")	\$ 53.37	\$790.13	\$775.43

Kool Tack Preserve Ultra

This archival drymount foamboard is designed for drymounting prints of value. With Preserve, you can drymount a print at 150°F to 155° F for 15 to 20 seconds and at a later date, completely remove the print with a minimal amount of heat.

Item #	Size	1 Sheet	1 Box/25sheets	2 Boxes
KTP3240	32x40 (3/16")	\$ 12.83	\$240.71	\$237.30
KTP4060	40x60 (3/16")	\$ 20.24	\$379.58	\$365.40

Kool Tack Fabric Mount *• For Fabric Projects*

Item #	Size	1 Sheet	1 Box/25sheets	2 Boxes
KTFM3240	32x40 (3/16")	\$ 12.57	\$188.48	\$172.73
KTFM4060	40x60 (3/16")	\$ 21.95	\$329.18	\$301.88

Kool Tack Mighty Tough *• 1/4" Thick • Warp Resistant*

White

Item #	Size	1 Sheet	1 Box/25sheets	2 Boxes
KTM3240	32x40 (1/4")	\$ 39.00	\$584.85	\$525.00
KTM4060	40x60 (1/4")	\$ 70.31	\$1054.46	\$946.58

Black

Item #	Size	1 Sheet	1 Box/25sheets	2 Boxes
KTM3240	32x40 (1/4")	\$ 36.33	\$544.95	\$519.49
KTM4060	40x60 (1/4")	\$ 53.99	\$809.81	\$772.01



It's all online at the
New **Omegamoulding.com!**

Our new and improved website features enhanced product views and search functions, making it easier than ever to find and order framing supplies 24/7!

See our newest products & current specials today!

OMEGA⁺ QUALITY FRAMING PRODUCTS

Bulk Quantity White Foam Board

Quality 3/16" white foam board available in pallet quantity from Omega. Clay-coated board with memory core for large production jobs.

Item #	Size	Qty	
4068BULK	32 x 40	700	Call for current pricing
6068BULK	40 x 60	400	Call for current pricing

M&M Heat Activated Foam Board

Specially formulated to be pH neutral. Permanently bonds in less than a minute! Always flat SuperCor substrate. Lower temperature, bonds at a cool 170-degrees.

Item #	Size	Per Sheet	1 Box Price	4 Boxes
2068U	3/16" 24 x 36	Box only	25 per box: \$ 83.74	\$ 79.54 ea.
2068A	3/16" 30 x 40	Box only	25 per box: \$119.96	\$114.19 ea.
2068E	1/8" 32 x 40	Box only	25 per box: \$114.98	\$109.20 ea.
2068B	3/16" 32 x 40	1-24 Sheets: \$6.18	25 per box: \$114.98	\$109.20 ea.
2068EO	1/8" 40 x 60	Box only	25 per box: \$218.66	\$207.90 ea.
2068C	3/16" 40 x 60	1-24 Sheets: \$12.62	25 per box: \$218.66	\$207.90 ea.





Bainbridge Artcare Foam Board

Artcare™ is the only foam board that's truly archival. Using MicroChamber® technology, it absorbs and neutralizes harmful gases and protects artwork well into the future. The opaque, lightly textured surface papers eliminate show-through and feature a soft white color that is suitable for floating applications.

Item #	Size	Per Sheet	1 Box Price	4 Boxes
8771	32 x 40 1/8"	1-24 Sheets: \$ 9.40	25 per box: \$145.69	\$138.34 ea.
8770	32 x 40 3/16"	1-24 Sheets: \$ 9.40	25 per box: \$145.69	\$138.34 ea.
8771A	40 x 60 1/8"	1-24 Sheets: \$15.11	25 per box: \$273.53	\$259.61 ea.
8770A	40 x 60 3/16"	1-24 Sheets: \$15.11	25 per box: \$273.53	\$259.61 ea.
8770D	48 x 96 3/16"	Box only	25 per box: \$596.66	\$567.00 ea.

Bainbridge Artcare Black Foam Board

Item #	Size	Per Sheet	1 Box Price	4 Boxes
8772	32 x 40 3/16"	1-24 Sheets: \$11.25	25 per box: \$211.58	\$203.18 ea.
8773	32 x 40 1/8"	1-24 Sheets: \$11.25	25 per box: \$211.58	\$203.18 ea.
8772A	40 x 60 3/16"	1-24 Sheets: \$23.78	25 per box: \$363.04	\$353.59 ea.

Bainbridge SpeedMount

Makes dry mounting faster than ever, to get through multiple jobs faster, an asset to production framers. SpeedMount works in just seconds and bonds at temperatures as low as 150°.

Item #	Size	Per Sheet	1 Box Price	4 Boxes
5100E	32 x 40 1/8"	Box only	25 per box: \$129.94	\$120.23 ea.
5100B	32 x 40 3/16"	1 - 24 Sheets: \$ 8.33	25 per box: \$129.94	\$120.23 ea.
5100EO	40 x 60 1/8"	Box only	25 per box: \$237.04	\$219.45 ea.
5100C	40 x 60 3/16"	1 - 24 Sheets: \$14.79	25 per box: \$237.04	\$219.45 ea.

Bainbridge SpeedMount Black

Item #	Size	Per Sheet	1 Box Price	4 Boxes
5101B	32 x 40 3/16"	1-24 Sheets: \$10.62	25 per box: \$172.99	\$160.13 ea.
5101C	40 x 60 3/16"	1-24 Sheets: \$20.29	25 per box: \$327.60	\$303.19 ea.

Bainbridge Artcare Restore

This product combines the renowned micro chamber technology of Artcare Foamboard with an acid free archival dry mounting adhesive pre coated onto the board. With Artcare Restore, you can safely reverse art to its exact, pre-mounting condition. The non-permeable adhesive meets all archival standards and can be completely removed from the art. Artcare Restore's breakthrough adhesive activates at low temperatures and short dwell times, making it safe for most art. Bonds at 150-170°F.

Item #	Size	Per Sheet	1 Box Price	4 Boxes
5103B	32 x 40 3/16"	1-24 Sheets: \$10.58	25 per box: \$202.65	\$192.41 ea.
ACRF4060	40 x 60 3/16"	1-24 Sheets: \$19.26	25 per box: \$370.39	\$351.75 ea.



Gilman Regular Foam Board

Paper-faced memory foamboard with the proprietary Reveal® foam center. Smooth bright-white clay coated paper engineered to retain its thickness during mounting, laminating, screen-printing and die-cutting.

Item #	Size	Per Sheet	1 Box Price	4 Boxes
4068T	20 x 30 3/16"	Box only	25 per box: \$39.11	\$ 35.18 ea.
4068U	24 x 36 3/16"	Box only	25 per box: \$50.66	\$ 45.68 ea.
4068M	30 x 42 3/16"	Box only	25 per box: \$92.66	\$ 83.48 ea.
4068E	32 x 40 1/8"	Box only	25 per box: \$68.25	\$ 61.69 ea.
4068B	32 x 40 3/16"	1-24 Sheets: \$ 5.58	25 per box: \$68.25	\$ 61.69 ea.
4068EO	40 x 60 1/8"	Box only	25 per box: \$129.68	\$116.81 ea.
4068C	40 x 60 3/16"	1-24 Sheets: \$11.18	25 per box: \$129.68	\$116.81 ea.
4068DE	48 x 96 1/8"	Box only	25 per box: \$258.04	\$232.31 ea.
4068D	48 x 96 3/16"	1-24 Sheets: \$27.75	25 per box: \$258.04	\$232.31 ea.
4068Z	60 x 96 3/16"	Box only	25 per box: \$444.15	\$400.31 ea.

Gilman Insite® Reveal Acid-Free Foam Board

Created for conservation mounting and framing, Insite® Reveal acid-free mounting boards deliver two-sided protection from damaging pollutants and harmful gases. Offers a pH value ranging from 7.5 - 9.5 and buffered with 3 -5 % calcium carbonate reserve. The liners are 100% High Alpha Cellulose virgin pulp, free from ground wood and/or post consumer materials.

Item #	Size	1 Box Price	4 Boxes
4068H	32 x 40 1/8"	25 per box: \$110.25	\$ 99.49 ea.
4068F	32 x 40 3/16"	25 per box: \$110.25	\$ 99.49 ea.
4068HO	40 x 60 1/8"	25 per box: \$199.76	\$180.08 ea.
4068G	40 x 60 3/16"	25 per box: \$199.76	\$180.08 ea.
4068P	48 x 96 3/16"	25 per box: \$390.08	\$351.49 ea.

Gilman Black Foam Board

Gilman's black foam board with rich black facing papers.

Item #	Size	Per Sheet	1 Box Price	4 Boxes
4068J	32 x 40 3/16"	1-24 Sheets: \$ 9.31	25 per box: \$110.78	\$ 99.75 ea.
4068L	40 x 60 3/16"	1-24 Sheets: \$16.44	25 per box: \$198.19	\$178.50 ea.
4068K	48 x 96 3/16"	1-24 Sheets: \$28.28	25 per box: \$403.20	\$363.56 ea.

Bainbridge® Bevel Accents • Artcare Bevel Accents are 5mm thick beveled foamboard strips, pre-wrapped in Bainbridge Artcare archival papers or Bainbridge fabrics. Due to their unique design, you can create a deep wrap bevel for any frame job in minutes, with no measuring required.

Alphamat Artcare Paper:

BA8005 Copper	BA8483 Baroque Ruby	• Each box contains 4 x 40" lengths
BA8125 Pearl Filigree	BA8526 Indigo	1-3 boxes • \$28.12 each
BA8448 Jalapeno	BA8540 Tartan Green	4 or more • \$26.43 each
BA8450 Denim Blue		

Specialty Fabrics:

BA4147 Spruce Suede	• Each box contains 4 x 40" lengths
BA4149 Wine Suede	1-3 boxes • \$33.15 each
BA4165 Coal Suede	4 or more • \$31.15 each
BA4835 Silken Green	
BA4840 White Silk	

Items with this symbol "Ride Along" with your length or chop moulding order at no extra delivery charge.

California Customers- WARNING: Cancer and Reproductive Harm - www.P65Warnings.ca.gov

FOME-COR®

Fome-Cor

Fome-Cor® Board is the industry's leading paper-faced foam board for more than 40 years. It is comprised of extruded polystyrene foam with clay-coated white or kraft black paper facers, one of which is covered with heat-activated adhesive. Made In USA.

Fome-Cor Clay Coat Foam Board

Item #	Size	1 Box Price	4 Boxes	8 + Boxes
FBR2436	3/16" 24 x 36	25 per box: \$ 46.20	\$ 43.84 ea.	\$ 41.48 ea.
FBR3240	3/16" 32 x 40	25 per box: \$ 64.58	\$ 61.43 ea.	\$ 58.28 ea.
FBRT3240	1/8" 32 x 40	25 per box: \$ 64.58	\$ 61.43 ea.	\$ 58.28 ea.
FBR4060	3/16" 40 x 60	25 per box: \$121.80	\$115.76 ea.	\$109.46 ea.
FBR4896	3/16" 48 x 96	25 per box: \$241.50	\$229.43 ea.	\$217.35 ea.

Fome-Cor Heat-Activated Foam Board

Item #	Size	1 Box Price	4 Boxes	8 + Boxes
FBS2436	3/16" 24 x 36	25 per box: \$ 67.20	\$ 63.79 ea.	\$ 60.38 ea.
FBS3240	3/16" 32 x 40	25 per box: \$ 95.55	\$ 90.83 ea.	\$ 85.84 ea.
FBS4060	3/16" 40 x 60	25 per box: \$180.60	\$171.41 ea.	\$162.49 ea.
FBS4896	3/16" 48 x 96	25 per box: \$420.00	\$387.45 ea.	\$367.50 ea.

Fome-Cor Acid-Free Foam Board

Item #	Size	1 Box Price	4 Boxes	8 + Boxes
FBA3240	3/16" 32 x 40	25 per box: \$ 99.75	\$ 94.76 ea.	\$ 89.78 ea.
FBA4060	3/16" 40 x 60	25 per box: \$178.50	\$169.58 ea.	\$160.65 ea.
FBA4896	3/16" 48 x 96	25 per box: \$349.13	\$331.80 ea.	\$314.48 ea.

Fome-Cor Black Foam Board

Item #	Size	1 Box Price	4 Boxes	8 + Boxes
FBB3240	3/16" 32 x 40	25 per box: \$100.75	\$ 95.81 ea.	\$ 91.35 ea.
FBB4060	3/16" 40 x 60	25 per box: \$184.80	\$175.61 ea.	\$166.16 ea.
FBB4896	3/16" 48 x 96	25 per box: \$373.01	\$354.38 ea.	\$337.84 ea.



MasterCore Foam Board*

Smooth white acid-free foam board with memory core.

*Currently, this product is shipped from Omega West only.

Item #	Size	Per Sheet	1 Box Price	4 Boxes	8 + Boxes
OAF3240	3/16" 32 x 40	1-24 Sheets: \$ 3.60	25 per box: \$ 71.93	\$ 68.25 ea.	\$ 64.84 ea.
OAF4060	3/16" 40 x 60	1-24 Sheets: \$ 6.73	25 per box: \$135.71	\$129.15 ea.	\$121.80 ea.
OAF4896	3/16" 48 x 96	1-24 Sheets: \$15.18	25 per box: \$270.64	\$257.25 ea.	\$243.86 ea.

GatorFoam

Lightweight, rigid white display board.

Dense and firm polystyrene core with wood fiber veneer laminate surface impregnated with resin for water resistance.

Item #	Description	Per Sheet	1 Box Price	4 Boxes
1072K	48 x 96 1/2" Kraft Color	1-11 Sheets: \$100.75	12 per box: \$1003.34	\$906.70 ea.
1072W	48 x 96 1/2" White	1-11 Sheets: \$102.60	12 per box: \$1110.82	\$982.55 ea.
1071K	48 x 96 3/16" Kraft Color	1-14 Sheets: \$ 69.43	15 per box: \$ 864.36	\$781.04 ea.
1071W	48 x 96 3/16" White	1-14 Sheets: \$ 70.97	15 per box: \$ 887.20	\$784.67 ea.
1071B	48 x 96 3/16" Black	1-14 Sheets: \$ 71.90	15 per box: \$ 893.66	\$790.34 ea.

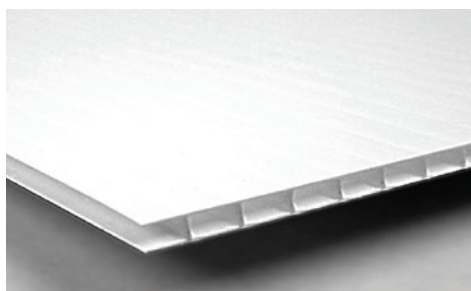

Coroplast

Corrugated plastic sheet that is archival, waterproof, weather and stain resistant. A great option for specialty framing, packaging and signage.

Item #	Description	Per Sheet	1 Box Price	4 Boxes
1067C	Coroplast 4mm 40 x 60	1-9 Sheets: \$28.94	10 per box: \$245.39	\$235.00 ea.
1067D	Coroplast 4mm 48 X 96	1-14 Sheets: \$54.73	15 per box: \$670.65	\$641.85 ea.

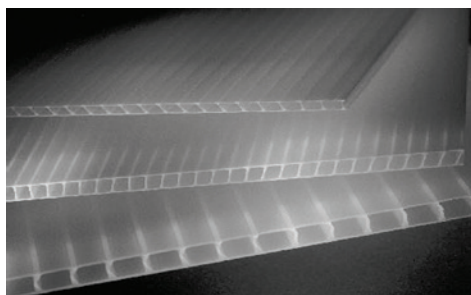

Omega Archival Polypropylene

Archival fluted polypropylene sheets similar to Coroplast, is acid-free, neutral pH with no dyes or additives. Also available in 6mm thickness by request.

Item #	Description	1-14 Sheets	15-59 sheets	60+ Sheets
AFP4060	Archival Polypropylene 40 x 60 4mm	\$14.47 ea.	\$12.97 ea.	\$11.51 ea.
AFP4896	Archival Polypropylene 48 x 96 4mm	\$22.97 ea.	\$20.77 ea.	\$18.48 ea.



Clear Select Regular 2mm Glass

2mm first quality float glass.
Washed, polished, & paper interleaved.

Item #	Size	Lites Per Box	1-2 Box Price	3-4 Box Price	5+ Box Price
RG810	8 x 10	90 lites/box	\$39.26	\$37.47	\$36.11
RG8511	8 1/2 x 11	77 lites/box	\$39.26	\$37.47	\$36.11
RG1114	11 x 14	47 lites/box	\$39.26	\$37.47	\$36.11
RG1216	12 x 16	38 lites/box	\$39.26	\$37.47	\$36.11
RG1418	14 x 18	29 lites/box	\$39.26	\$37.47	\$36.11
RG1620	16 x 20	23 lites/box	\$35.16	\$33.38	\$32.01
RG1824	18 x 24	17 lites/box	\$35.16	\$33.38	\$32.01
RG2024	20 x 24	15 lites/box	\$35.16	\$33.38	\$32.01
RG2228	22 x 28	12 lites/box	\$35.16	\$33.38	\$32.01
RG2430	24 x 30	10 lites/box	\$35.16	\$33.38	\$32.01
RG2436	24 x 36	8 lites/box	\$35.16	\$33.38	\$32.01
RG2632	26 x 32	9 lites/box	\$35.16	\$33.38	\$32.01
RG2636	26 x 36	8 lites/box	\$35.16	\$33.38	\$32.01
RG2838	28 x 38	7 lites/box	\$35.16	\$33.38	\$32.01
RG3032	30 x 32	8 lites/box	\$35.16	\$33.38	\$32.01
RG3036	30 x 36	7 lites/box	\$35.16	\$33.38	\$32.01
RG3040	30 x 40	6 lites/box	\$35.16	\$33.38	\$32.01
RG3240	32 x 40	6 lites/box	\$35.16	\$33.38	\$32.01
RG3648	36 x 48	4 lites/box	\$35.16	\$33.38	\$32.01
RG4060	40 x 60	3 lites/box	\$39.26	\$37.47	\$36.11
RG4048	40 x 48	4 lites/box	\$39.26	\$37.47	\$36.11

Clear Select Regular 2.5mm Glass

2.5mm first quality float glass.
Washed, polished, & paper interleaved.

Item #	Size	Lites Per Box	1-2 Box Price	3-9 Box Price	10+ Box Price
RGH1114	11 x 14	47 lites/box	\$45.34	\$39.89	\$37.62
RGH1216	12 x 16	38 lites/box	\$45.34	\$39.89	\$37.62
RGH1418	14 x 18	29 lites/box	\$45.34	\$39.89	\$37.62
RGH1620	16 x 20	15 lites/box	\$41.93	\$36.91	\$34.81
RGH2024	20 x 24	15 lites/box	\$41.93	\$36.91	\$34.81
RGH2228	22 x 28	12 lites/box	\$41.93	\$36.91	\$34.81
RGH2436	24 x 36	8 lites/box	\$41.93	\$36.91	\$34.81
RGH3240	32 x 40	6 lites/box	\$41.93	\$36.91	\$34.81
RGH3648	36 x 48	4 lites/box	\$41.93	\$36.91	\$34.81
RGH4060	40 x 60	3 lites/box	\$43.03	\$37.86	\$35.69

Non-Glare 2mm Glass

2mm single-side micro-etched non-glare glass for highest clarity.
Washed, polished, & paper interleaved.

Item #	Size	Lites Per Box	1-2 Box Price	3-9 Box Price	10+ Box Price
NG1620	16 x 20	23 lites/box	\$83.99	\$73.90	\$69.71
NG2024	20 x 24	15 lites/box	\$83.99	\$73.90	\$69.71
NG2228	22 x 28	12 lites/box	\$83.99	\$73.90	\$69.71
NG2430	24 x 30	10 lites/box	\$83.99	\$73.90	\$69.71
NG2436	24 x 36	8 lites/box	\$83.99	\$73.90	\$69.71
NG3240	32 x 40	6 lites/box	\$83.99	\$73.90	\$69.71
NG3648	36 x 48	4 lites/box	\$83.99	\$73.90	\$69.71
NG4060	40 x 60	3 lites/box	\$87.65	\$81.76	\$77.11

Tru Vue Premium Clear Acrylic

66% UV Blocking, 92% light transmission,
8% reflection.

Item #	Size	1 Box Price	2+ Box Price@
414L	32x40 (2.3mm)	3 shts/box: \$ 67.20	6 shts: \$ 64.51
415	40x60 (3mm)	2 shts/box: \$ 91.15	4 shts: \$ 87.51

Tru Vue Conservation Clear Acrylic

99% UV Blocking, 92% light transmission,
8% light reflection.

Item #	Size	1 Box Price	2+ Box Price@
444L	32x40 (3mm)	3 shts/box: \$ 98.69	6 shts: \$ 94.74
445	40x60 (3mm)	2 shts/box: \$164.84	4 shts: \$158.25

Tru Vue Reflection Control Acrylic (Non-Glare)

66% UV Blocking, 92% light transmission,
8% Non-Glare scattered light reflection.

Item #	Size	1 Box Price	2+ Box Price@
435	40x60 (3mm)	2 shts/box: \$146.57	4 shts: \$140.71

Tru Vue Conservation Reflection Control Acrylic (Non Glare)

99% UV Blocking, 92% light transmission,
8% Non Glare scattered light reflection.

Item #	Size	1 Box Price	2+ Box Price@
454L	32x40 (3mm)	3 shts/box: \$107.10	6 shts: \$102.82
455	40x60 (3mm)	2 shts/box: \$172.50	4 shts: \$165.61

Tru Vue TruLife™ Acrylic (Anti-reflective) • New!

Single sided anti-reflective acrylic developed specifically for face/second surface mounting and direct print applications.

Item #	Size	Each	3 sheets	5 sheets
TVTL4896	48x96 (3mm)	\$374.98	\$359.79 ea.	\$345.77 ea.



Optium Museum Acrylic by Tru Vue

Durable and strong, **Optium** is produced using a patented Tru Vue technology. A magnetron-sputtered anti-reflective, anti-static coating is bonded to an abrasion resistant, UV filtering acrylic sheet. This ensures long-lasting protection that doesn't oxidize and degrade over time.

- 99% UV Blocking • Over 98% light transmission
- Less than 1.5% Reflection • Anti-static & Abrasion Resistant

Item #	Size (sheets/box)	1 Box	3 Boxes @	5 Boxes @
TO2436M	24x36 •3mm (2 sht.)	\$ 325.58	\$ 315.82	\$ 306.05
TO3240M	32x40 •3mm (2 sht.)	\$ 482.35	\$ 467.88	\$ 453.41
TO3648M	36x48 •3mm (1 sht.)	\$ 325.58	\$ 315.82	\$ 306.05
TO4060M	40x60 •3mm (1 sht.)	\$ 452.20	\$ 438.64	\$ 425.07

Item #	Size	1 Sheet	3 Sheet @	5 Sheet @
TO4896M	48x96 (3mm)	\$ 779.00	\$ 758.79	\$ 730.39
TO7296M	72x96 (4.5mm)	\$2159.00	\$2105.00	\$2015.00
TO120M6	72x120 (6mm)	\$4359.00	\$4250.00	\$3919.00

Optium Anti-Reflective AR Acrylic

- 93% UV Blocking • Over 98% light transmission
- Less than 1.6% Reflection • Anti-static & Abrasion Resistant

Item #	Size	1 Sheet	3 Sheet @	5 Sheet @
TO4896	48x96 (3mm)	\$ 725.00	\$ 705.69	\$ 679.75

Optium Acrylic *Cut To Size*

Item #	Size/Description	Price
UTLCUT	*Single cut on 3mm Optium Acrylic	\$ 35.00/*cut
OPTI-3	3mm Optium AR 93% UV Protection	\$ 36.75/sq. ft.
OPTI-M3	3mm Optium Museum 99% UV	\$ 42.00/sq. ft.
OPTI-M45	4.5mm Optium Museum 99% UV	\$ 69.30/sq. ft.
OPTI-M6	6mm Optium Museum 99% UV	\$105.00/sq. ft.



*Tru Vue glass products are currently available in ME, VT, NH, RI, CT, NY, NJ, PA, MD, DC, & SF only.



Tru Vue

Tru Vue sets the standard in high-performance glazing that enhances and protects. From design and conservation in custom frame shops, to museums and galleries across the globe, to anti-reflective custom coatings for commercial applications, Tru Vue is known as a leader and innovator in the protection and conservation of all things framed and displayed. Whether it's Museum Glass®, Conservation Clear®, or Optium® Acrylic Glazing, no other company has such a complete portfolio of high-performance glazing options as Tru Vue.

Tru Vue Premium Clear*

45% UV Blocking, 90% light transmission, 8% reflection, 2.5mm, 50 sq. ft. per box.

Item #	Size (Lites Per Box)	1 Box	3 Box@	6 Box@
TVPC1114	11x14 (47 lites)	\$ 65.84	\$ 62.84	\$ 59.85
TVPC1216	12x16 (38 lites)	\$ 65.84	\$ 62.84	\$ 59.85
TVPC1418	14x18 (29 lites)	\$ 65.84	\$ 62.84	\$ 59.85
TVPC1620	16x20 (23 lites)	\$ 49.71	\$ 47.45	\$ 45.19
TVPC1824	18x24 (17 lites)	\$ 49.71	\$ 47.45	\$ 45.19
TVPC2024	20x24 (15 lites)	\$ 49.71	\$ 47.45	\$ 45.19
TVPC2228	22x28 (12 lites)	\$ 49.71	\$ 47.45	\$ 45.19
TVPC2430	24x30 (10 lites)	\$ 49.71	\$ 47.45	\$ 45.19
TVPC2436	24x36 (8 lites)	\$ 49.71	\$ 47.45	\$ 45.19
TVPC2632	26x32 (9 lites)	\$ 49.71	\$ 47.45	\$ 45.19
TVPC2636	26x36 (8 lites)	\$ 49.71	\$ 47.45	\$ 45.19
TVPC2836	28x36 (7 lites)	\$ 49.71	\$ 47.45	\$ 45.19
TVPC2838	28x38 (7 lites)	\$ 49.71	\$ 47.45	\$ 45.19
TVPC3036	30x36 (7 lites)	\$ 49.71	\$ 47.45	\$ 45.19
TVPC3240	32x40 (6 lites)	\$ 49.71	\$ 47.45	\$ 45.19
TVPC3648	36x48 (4 lites)	\$ 49.71	\$ 47.45	\$ 45.19
TVPC4060	40x60 (3 lites)	\$ 64.27	\$ 61.35	\$ 58.43

Tru Vue AR Reflection Free Glass*

78% UV Blocking, 97% light transmission, 2.5mm, Less than 1% reflection. 25 sq. ft. per box.

Item #	Size (Lites Per Box)	1 Box	3 Box@	6 Box@
TVAR1620	16x20 (3 lites)	\$ 51.49	\$ 47.93	\$ 45.65
TVAR2436	24x36 (4 lites)	\$ 134.28	\$ 124.99	\$ 119.04
TVAR3240	32x40 (3 lites)	\$ 150.09	\$ 139.71	\$ 133.06
TVAR3648	36x48 (2 lites)	\$ 134.28	\$ 124.99	\$ 119.04
TVAR4060	40x60 (2 lites)	\$ 205.35	\$ 191.15	\$ 182.05

Tru Vue Conservation Clear*

99% UV Blocking, 89% light transmission, 2.5mm, 8% reflection. 50 sq. ft. per box. (40x60 is 25 sq. ft. per box)

Item #	Size (Lites Per Box)	1 Box	3 Box@	6 Box@
TVCC1114	11x14 (47 lites)	\$ 112.72	\$ 104.93	\$ 99.93
TVCC1216	12x16 (38 lites)	\$ 112.72	\$ 104.93	\$ 99.93
TVCC1418	14x18 (29 lites)	\$ 112.72	\$ 104.93	\$ 99.93
TVCC1620	16x20 (23 lites)	\$ 89.90	\$ 83.69	\$ 79.70
TVCC1824	18x24 (17 lites)	\$ 89.90	\$ 83.69	\$ 79.70
TVCC2024	20x24 (15 lites)	\$ 89.90	\$ 83.69	\$ 79.70
TVCC2228	22x28 (12 lites)	\$ 89.90	\$ 83.69	\$ 79.70
TVCC2430	24x30 (10 lites)	\$ 89.90	\$ 83.69	\$ 79.70
TVCC2436	24x36 (8 lites)	\$ 89.90	\$ 83.69	\$ 79.70
TVCC2632	26x32 (9 lites)	\$ 89.90	\$ 83.69	\$ 79.70
TVCC3240	32x40 (6 lites)	\$ 89.90	\$ 83.69	\$ 79.70
TVCC3648	36x48 (4 lites)	\$ 89.90	\$ 83.69	\$ 79.70
TVCC4060	40x60 (2 lites)	\$ 71.02	\$ 66.14	\$ 62.99
TVCC4868	48x68 (2 lites)	\$ 94.74	\$ 88.19	\$ 83.99

Tru Vue Museum Glass*

99% UV Blocking, 96% light transmission, 2.5mm, 1% reflection. 35 sq. ft. per box.

Item #	Size (Lites Per Box)	1 Box	3 Box@	6 Box@
TVMG1114	11x14 (32 lites)	\$ 352.76	\$ 320.69	\$ 291.54
TVMG1418	14x18 (20 lites)	\$ 352.76	\$ 320.69	\$ 291.54
TVMG1620	16x20 (16 lites)	\$ 311.13	\$ 282.84	\$ 257.13
TVMG1824	18x24 (12 lites)	\$ 311.13	\$ 282.84	\$ 257.13
TVMG2024	20x24 (11 lites)	\$ 311.13	\$ 282.84	\$ 257.13
TVMG2228	22x28 (8 lites)	\$ 311.13	\$ 282.84	\$ 257.13
TVMG2430	24x30 (7 lites)	\$ 311.13	\$ 282.84	\$ 257.13
TVMG2436	24x36 (6 lites)	\$ 311.13	\$ 282.84	\$ 257.13
TVMG3240	32x40 (4 lites)	\$ 311.13	\$ 282.84	\$ 257.13
TVMG3648	36x48 (3 lites)	\$ 311.13	\$ 282.84	\$ 257.13
TVMG4060	40x60 (2 lites)	\$ 304.77	\$ 277.07	\$ 251.88
TVMG4868	48x68 (2 lites)	\$ 399.95	\$ 373.45	\$ 339.50
50 Sq. Ft Boxes		1 Box	3 Box@	6 Box@
DMG2436	24x36 (8 lites)	\$ 358.73	\$ 347.96	\$ 337.53
DMG3240	32x40 (6 lites)	\$ 383.06	\$ 371.57	\$ 360.43

"Try It" Packs 1 Pack

SSMG1620	16x20 (4 lites per pack)	\$ 92.00
SSMG32	32x40 (1 lite pack)	\$ 79.56

Tru Vue UltraVue*

65% UV blocking, 98.5% light transmission, 2mm Water White glass, anti-reflective. 25 sq. ft. per box.

Item #	Size (Lites Per Box)	1 Box	3 Box@	6 Box@
TVUV2436	24x36 (4 lites)	\$ 102.31	\$ 99.47	\$ 94.73
TVUV3240	32x40 (3 lites)	\$ 119.80	\$ 116.48	\$ 110.93
TVUV3648	36x48 (2 lites)	\$ 109.95	\$ 106.90	\$ 101.81
TVUV4060	40x60 (2 lites)	\$ 149.99	\$ 146.95	\$ 139.95
TVUV4868	48x68 (2 lites)	\$ 214.67	\$ 208.71	\$ 198.77

Tru Vue UltraVue Laminated Glass

99% UV Blocking Anti-Reflective Glass 98% light transmission, Water White base, laminated - will not shatter. Available in 4.4mm & 6.4mm.

• Cut To Size

Item #	Size/Description	Price Per Sq. Ft.
LGL100	4.4mm UltraVue Laminated Glass	\$ 65.00

TruVue Reflection Control*

45% UV Blocking, 89% light transmission, 8% Non- Glare scattered light reflection, 2.5mm. 50 sq. ft. per box.

Item #	Size (Lites Per Box)	1 Box	3 Box@	6 Box@
TVRC1114	11x14 (47 lites)	\$ 106.33	\$ 101.50	\$ 96.66
TVRC1418	14x18 (29 lites)	\$ 106.33	\$ 101.50	\$ 96.66
TVRC1620	16x20 (23 lites)	\$ 98.22	\$ 93.75	\$ 89.29
TVRC1824	18x24 (17 lites)	\$ 98.22	\$ 93.75	\$ 89.29
TVRC2024	20x24 (15 lites)	\$ 98.22	\$ 93.75	\$ 89.29
TVRC2228	22x28 (12 lites)	\$ 98.22	\$ 93.75	\$ 89.29
TVRC2430	24x30 (10 lites)	\$ 98.22	\$ 93.75	\$ 89.29
TVRC2436	24x36 (8 lites)	\$ 98.22	\$ 93.75	\$ 89.29
TVRC2632	26x32 (9 lites)	\$ 98.22	\$ 93.75	\$ 89.29
TVRC3036	30x36 (7 lites)	\$ 98.22	\$ 93.75	\$ 89.29
TVRC3240	32x40 (6 lites)	\$ 98.22	\$ 93.75	\$ 89.29
TVRC3648	36x48 (4 lites)	\$ 98.22	\$ 93.75	\$ 89.29
TVRC4060	40x60 (2 lites)	\$ 92.86	\$ 88.64	\$ 84.42

Tru Vue Conservation Reflection Control*

(Non-Glare) 99% UV Blocking, 89% light transmission, 8% Non- Glare scattered light reflection, 2.5mm.

Item #	Size (Lites Per Box)	1 Box	3 Box@	6 Box@
TVCR1620	16x20 (23 lites)	\$ 192.46	\$ 178.20	\$ 162.00
TVCR1824	18x24 (17 lites)	\$ 192.46	\$ 178.20	\$ 162.00
TVCR2024	20x24 (15 lites)	\$ 192.46	\$ 178.20	\$ 162.00
TVCR2228	22x28 (12 lites)	\$ 192.46	\$ 178.20	\$ 162.00
TVCR2430	24x30 (10 lites)	\$ 192.46	\$ 178.20	\$ 162.00
TVCR2436	24x36 (8 lites)	\$ 192.46	\$ 178.20	\$ 162.00
TVCR3240	32x40 (6 lites)	\$ 192.46	\$ 178.20	\$ 162.00
TVCR3648	36x48 (4 lites)	\$ 192.46	\$ 178.20	\$ 162.00
TVCR4060	40x60 (2 lites)	\$ 126.94	\$ 117.53	\$ 106.85





Artglass Water White AR UV Glass

State-of-the-art technology allows Artglass™ to have the lowest visible light reflection, precisely tuned for unparalleled clarity and color correctness.

- Reflection free • Neutral reflected color
- True color transparency and superior clarity of image
- High durability coating, suited for outdoor applications
- Easy to clean, handle, & store.
- UV70 & UV92 are coated on both sides; cut any side.

Artglass Water White UV70

70% UV Protection • <1% Reflection • 2mm

Item #	Size (Lites Per Box)	1 Box	3 Box@
AG1620	16x20 (12 lites)	\$134.10	\$127.40
AG2436	24x36 (4 lites)	\$134.10	\$127.40
AG3240	32x40 (3 lites)	\$134.10	\$127.40
AG3648	36x48 (2 lites)	\$134.10	\$127.40
AG4060	40x60 (2 lites)	\$202.01	\$191.91

Artglass Water White UV92

92% UV Protection • <1% Reflection • 2mm

Item #	Size (Lites Per Box)	1 Box	3 Box@
AG1620UV	16x20 (16 lites)	\$280.67	\$252.60
AG2436UV	24x36 (6 lites)	\$280.67	\$252.60
AG3240UV	32x40 (4 lites)	\$280.67	\$252.60
AG3648UV	36x48 (3 lites)	\$280.67	\$252.60
AG4060UV	40x60 (2 lites)	\$290.87	\$261.79
AG4864UV	48x64 (2 lites)	\$354.51	\$319.06

Artglass UV99

99% UV Protection • <1% Reflection • 2mm

Item #	Size (Lites Per Box)	1 Box	3 Box@
ARC91620	16x20 (16 lites)	\$286.36	\$262.50
ARC92024	20x24 (10 lites)	\$286.36	\$262.50
ARC92228	22x28 (8 lites)	\$286.36	\$262.50
ARC92436	24x36 (6 lites)	\$286.36	\$262.50
ARC93240	32x40 (4 lites)	\$286.36	\$262.50
ARC93648	36x48 (3 lites)	\$286.36	\$262.50
ARC94060	40x60 (2 lites)	\$286.36	\$262.50



Artglass Preservation Clear™

Preservation Clear UV 99™ provides UV protection by blocking out 99% of harmful rays thus helping prevent the treasured keepsake from fading. Preservation Clear UV 99™ is your great choice for picture framing. Preservation Clear has no "orange peel" surface distortion and has a neutral color that won't effect the color of your artwork.

Item #	Size (Lites Per Box)	1 Box	3 Box@
APC91620	16x20 (23 lites)	\$ 88.57	\$ 83.33
APC92024	20x24 (15 lites)	\$ 88.57	\$ 83.33
APC92228	22x28 (12 lites)	\$ 88.57	\$ 83.33
APC92436	24x36 (8 lites)	\$ 88.57	\$ 83.33
APC93240	32x40 (6 lites)	\$ 88.57	\$ 83.33
APC93648	36x48 (4 lites)	\$ 88.57	\$ 83.33
APC94060	40x60 (2 lites)	\$ 88.57	\$ 83.33



Acrylite Acrylic

Guaranteed to be defect free, ACRYLITE® acrylic sheet framing products are manufactured to more stringent specifications than standard acrylic sheet, eliminating dirt and blemishes that could potentially produce imperfections when viewing framed artwork. Our selection of Acrylite picture framing products include acrylics with UV filtering properties, non-glare options or with an abrasion and chemical resistant coating for ultimate protection.

Acrylite Clear Acrylic

.06 to .118 gauge framing grade acrylic FF3.

Item #	Size, Gauge (Mask)	1 Sheet	5-9	10+
PXC3240	32x40 .118 (TE Mask)	\$ 24.98	\$ 23.74	\$ 22.49
PXC4060	40x60 .118 (TE Mask)	\$ 50.34	\$ 47.82	\$ 45.30
PXCP4060	40x60 .118 (paper)	\$ 54.36	\$ 54.63	\$ 48.92
PX9606F	48x96 .06 (TE Mask)	\$ 46.79	\$ 44.46	\$ 42.12
PX9608F	48x96 .08 (TE Mask)	\$ 56.58	\$ 53.75	\$ 50.93
PX9698FC	48x96 .098 (TE Mask)	\$ 59.90	\$ 56.90	\$ 53.92
PX5110F	51x100 .098 (TE Mask)	\$ 72.86	\$ 69.23	\$ 65.57
501	36x72 .118 (TE Mask)	\$ 54.02	\$ 51.32	\$ 48.63
PXC4896	48x96 .118 (TE Mask)	\$ 77.49	\$ 73.63	\$ 69.74
PXCP4896	48x96 .118 (paper)	\$ 88.14	\$ 83.73	\$ 79.33
PX6096F	60x96 .118 (TE Mask)	\$103.99	\$ 98.78	\$ 93.59
PX60120P	60x120 .118(paper)	\$156.23	\$148.42	\$140.61
PXC5110P	51x100 .118(paper)	\$106.55	\$101.22	\$ 95.90
PXC60120	60x120 .118 (TE Mask)	\$139.09	\$132.13	\$125.19

Acrylite Non Glare Acrylic

.098 to .118 gauge non-glare picture framing acrylic. TE masking.

Item #	Size, Gauge, Description	1 Sheet	5-9	10+
PXNG698	48x96 .098 FF3 P99	\$103.33	\$ 98.15	\$ 93.00
PXNG4896	48x96 .118 FF3 P99	\$117.36	\$111.50	\$105.63

VariGuard Smart Glass

VariGuard SmartGlass™ is the first and only display panel that offers a wide range of visible light transmission, instant switching between dark and clear states, and 99% UV-blocking at all times. Based on patented SPD light-control technology developed by Research Frontiers, VariGuard display panels optimally protect artifacts by limiting their light-exposure only to those times when people are viewing them.



Acrylite UV Protection Acrylic

.098 to .118 gauge 98% UV filtering 92% transmission picture framing OP3 acrylic. PM=Paper mask, TE=TE film mask.

Item #	Size, Gauge, Description	1 Sheet	5-9	10+
PXUV4060	40x60 .118 (PM)	\$102.52	\$ 97.40	\$ 92.26
PXUV9698	48x96 .098 (TE)	\$134.51	\$127.79	\$121.05
PXUV4896	48x96 .118 (TE)	\$168.22	\$159.81	\$151.40
PXUV6096	60x96 .118 (TE)	\$194.04	\$184.34	\$174.64
PXUV5110	51x100 .118 (TE)	\$208.53	\$198.10	\$187.68
PXU60120	60x120 .118 (PM)	\$281.15	\$267.09	\$253.04
505	48x96 .118 (TE)	\$274.95	\$261.21	\$247.45

• Mar Resist UV Acrylic

Cut-To-Size Acrylite Acrylic

Order any custom size precut from Omega. Convenient for large quantity jobs and large sizes, saving time and trouble and ensuring precision.

Item #	Description	Price Per Sq. Ft.
3501	.098 Clear Acrylic (TE Mask)	\$ 3.58
3500	.118 Clear Acrylic (TE Mask)	\$ 4.24
3502	.118 Non Glare Acrylic (TE Mask)	\$ 4.90
3504	.118 UV Non Glare OP3 P99 (Paper Mask)	\$ 9.38
3505	.118 Mar Resistant OP3 (TE Mask)	\$13.13
3506	.118 Clear (oversize, exceeding 48"x96")	\$ 6.62
3507	.118 Clear UV Clear UF3 (Oversized)	\$10.38
3503UF	.118 UV Clear OP3 (Paper Mask)	\$ 7.99
3508	.118 Clear Acrylic (Paper Mask)	\$ 4.66
3509	.098 Non Glare (TE Mask)	\$ 4.33
3510	.060 Clear Acrylic (TE Mask)	\$ 2.18
3511	.098 UV Clear Acrylic	\$ 6.53
3512	.080 Clear Acrylic (TE Mask)	\$ 2.48
3513	.098 UV Non Glare OP3 P99 (Paper Mask)	\$ 8.84

Acrylite Non-Glare UV Protection Acrylic

.098 to .118 gauge non-glare 98% UV protection 92% transmission picture framing acrylic. TE masking.

Item #	Size, Gauge, Description	1 Sheet	5-9	10+
PXUVNG98	48x96 .098 P99 OP3	\$174.55	\$165.82	\$157.09
PXUVNG18	48x96 .118 P99 OP3	\$205.07	\$194.82	\$184.56

- Laminated glazing for added strength and security
- Wide range of visible light transmission
- Instant switching between light-blocking and light-transmissive states
- Light-blocking default state; no power required for maximum protection
- Nominal power draw in light-transmissive state
- 99% UV blocking at all times
- Optional features: Anti-Reflection, IR-Rejection, Ballistic/Blast-Resistance



> For more information on VariGuard Smart Glass, call Omega today or visit www.museumglazing.com

Quality Mirror Products by **OMEGA**



Premium Beveled Mirrors

All mirrors are washed, polished, and ready to frame. Individually boxed with corner protectors. 1/4" mirror with 1 1/4" bevel edge and sealed back.

Item #	Mirror Size	1 Pc.	5-9 pcs.@	10+@
BVM810	8 x 10	\$ 9.71	\$ 8.74	\$ 7.28
BVM1620	16 x 20	\$17.81	\$16.03	\$13.37
BVM2024	20 x 24	\$25.03	\$22.52	\$18.77
BVM2228	22 x 28	\$29.75	\$26.76	\$22.31
BVM2430	24 x 30	\$32.04	\$28.84	\$24.03
BVM2436	24 x 36	\$35.48	\$31.93	\$26.62
BVM3040	30 x 40	\$50.36	\$45.34	\$37.78
BVM3248	32 x 48	\$66.21	\$59.60	\$49.65
BVM3648	36 x 48	\$66.05	\$59.44	\$49.54
BVM1860	18 x 60	\$52.05	\$46.83	\$39.03
BVM2460	24 x 60	\$57.84	\$52.07	\$43.40

Flat Mirrors

1/8" mirror sheets that you can cut to size for custom jobs. Mirrors are washed, polished and individually packed. Mirrors are painted and sealed on back.

Item #	Mirror Size	1 Pc.	4+ pcs.@
RM3240	32 x 40	\$30.84	\$23.15
RM3648	36 x 48	\$40.01	\$30.01
RM4060	40 x 60	\$56.37	\$42.27

Special Order Custom Mirrors

Need a custom size beveled mirror, or an oversized or pre-sized flat mirror? Call Omega with your dimensions and we'll do the rest!

Item #	Type	Price
990BV	Beveled Mirror	Call for pricing
991	Flat Mirror	Call for pricing
992	Antique Finish • Flat	Call for pricing



210 Brand Plastic Cleaner

A must-have for cleaning and treating acrylic prior to framing. Cleans fast and leaves a protective coating that resists fingerprints, gives materials a lustrous look. Contains a powerful anti-static agent that when used in combination with the 4" Anti-Static Brush virtually eliminates static charge. 

Item #	Size	1 Can	12 or more
4520	7 oz.	\$ 8.30	\$ 7.88 each
4520A	14 oz.	\$10.98	\$10.44 each



210 Plastic Scratch Remover

210 Plus Plastic Scratch Remover will remove all but the deepest surface scratches. Restores a brilliant finish to formerly dull surfaces. Anti-static and anti-fog. Use on Plexiglas®, Acrylite® and similar products. 15oz. bottle 

Item #	Size	1 Bottle	12 or more
4521	15 oz.	\$13.24	\$12.58 each



Sprayway Plastic Cleaner

Formulated for use on many surfaces including acrylics, Plexiglas, glass, polycarbonates, chrome, and Formica. Repels finger smudges, dirt and dust. Leaves acrylic Anti-static, anti-fog. Fast-drying, non-streaking. Contains no chemicals or abrasives. 19 oz. can 

Item #	Size	1 Can	12 or more
SP848	19 oz.	\$ 4.57	\$ 4.12 each



Sprayway Glass Cleaner

The World's Best Glass Cleaner. In addition to framing, it is excellent for windows, mirrors, windshields and other glass surfaces. Dissolves dirt, grease, grit, and grime. Guaranteed to leave no film or streaking. Contains perfume-grade alcohol for best performance. Ammonia-free. 19 oz. can 

Item #	Size	1 Can	12 or more
SP50	19 oz.	\$ 4.12	\$ 3.71 each

NOVUS

Novus #1 Acrylic Cleaner

Gently cleans all plastics without scratching. Leaves a lustrous shine that resists fogging, repels dust, eliminates static and resists fingerprints. Contains no abrasives or harsh chemicals. Leaves a smooth, clean, greaseless shine. 8oz. bottle 



Item #	Size	Each
NPC10	8 oz. bottle	\$ 4.05

Novus #2 Scratch Remover

Removes fine scratches, haziness and abrasions from most plastics. With repeated use, NOVUS No. 2 restores faded and discolored plastics. Removes the damage instead of filling it in. Buffs out quickly. After restoring, seals with a coat of polish. 8oz. bottle 



Item #	Size	Each
NPC20	8 oz. bottle	\$ 5.72

Novus #3 Deep Scratch Repair

Removes heavy scratches and abrasions from most acrylic surfaces. Use when damage is too severe to be restored with NOVUS No. 2 polish. Requires use of NOVUS No. 2 for final finishing. Not recommended for use on coated plastics. 8oz. bottle 



Item #	Size	Each
NPC30	8 oz. bottle	\$ 7.52

Novus Acrylic Cleaner Starter Kit 

2oz. Polish 1 - Clean & Shine
2oz. Polish 2 - Fine Scratch Remover
2oz. Polish 3 - Deep Scratch Repair
Comes with 2 NOVUS Polish Mates cloths and product brochure.



Item #	Description	Each
NPC7136	Novus Starter Kit	\$13.44

Ultra Lite Glass & Plastic Cleaner

No alcohol, No ammonia. One 8 oz. Ultra Lite Concentrated Glass & Plastic Cleaner makes 1 gallon and is guaranteed not to streak when diluted with distilled water.



Item #	Description	Each
590885	8 oz. bottle	\$19.60 

TRU VUE

TruVue Premium Clean Glass Cleaner 

Ammonia-free, safe for any picture framing glass. Soap free, will not lather or foam. Easy to use; static-free deionized formula repels dust.



Item #	Size	1 Bottle	4 or more
2069	26 oz. bottle	\$ 5.39	\$ 5.12 each
2068	1 Gallon	\$13.89	\$13.20 each





3M ATG

3M 924 ATG

3M® 924 is a medium-tack ATG, ideal for bonding a wide variety of materials such as papers, wood, foam board, and plastics. Applications include mounting picture frame mat boards and dust covers. For use with 3M Scotch® (and similar type) ATG Adhesive Applicators. 

Item #	Size	1 Roll	12+Rolls@	72+Rolls@
--------	------	--------	-----------	-----------

3M924146	1/4" x 36 yds	\$ 3.95	\$ 3.68	\$ 3.55
3M92412	1/2" x 36 yds	\$ 4.87	\$ 4.54	\$ 4.41
3M92460	1/2" x 60 yds	\$ 7.85	\$ 7.18	\$ 6.83

Item #	Size	1 Roll	12+Rolls@	48+Rolls@
--------	------	--------	-----------	-----------

3M92434	3/4" x 36 yds	\$ 6.60	\$ 6.04	\$ 5.99
3M924346	3/4" x 60 yds	\$11.37	\$10.56	\$ 9.89

3M 926 ATG

3M® 926 is ideal for applications requiring **high bond strength**, high shear strength and high temperature performance. Ideal for bonding heavyweight papers and boards. 

Item #	Size	1 Roll	12+Rolls@	72+Rolls@
--------	------	--------	-----------	-----------

3M92612	1/2" x 36 yds	\$16.96	\$15.78	\$14.93
---------	---------------	---------	---------	---------

Item #	Size	1 Roll	12+Rolls@	48+Rolls@
--------	------	--------	-----------	-----------

3M92634	3/4" x 36 yds	\$22.63	\$21.03	\$19.90
---------	---------------	---------	---------	---------

3M 969 ATG

3M® 969 is a **high tack** adhesive transfer tape, ideal for applications requiring high bond strength, high shear strength and high temperature performance. For use with 3M Scotch® (and similar type) ATG Adhesive Applicators. 

Item #	Size	1 Roll	12+Rolls@	72+Rolls@
--------	------	--------	-----------	-----------

3M969146	1/4" x 36 yds	\$11.07	\$10.30	\$ 9.74
3M96918	1/2" x 18 yds	\$ 7.42	\$ 6.90	\$ 6.67
3M96936	1/2" x 36 yds	\$13.84	\$12.84	\$12.51

Item #	Size	1 Roll	12+Rolls@	48+Rolls@
--------	------	--------	-----------	-----------

3M969348	3/4" x 18 yds	\$10.53	\$ 9.72	\$ 9.40
3M969346	3/4" x 36 yds	\$21.20	\$19.65	\$18.48

3M 465 ATG

3M® 465 medium-firm acrylic pressure-sensitive adhesive reverse wound on 3" core. High initial adhesion (quick stick) and good shear holding power. It is designed for manual or hand application. 

Item #	Size	1 Roll	12+Rolls@	72+Rolls@
--------	------	--------	-----------	-----------

3M46514	1/4" x 60 yds	\$ 7.80	\$ 7.36	\$ 7.22
3M46512	1/2" x 60 yds	\$11.55	\$10.68	\$10.04

Item #	Size	1 Roll	12+Rolls@	48+Rolls@
--------	------	--------	-----------	-----------

3M46534	3/4" x 60 yds	\$15.45	\$14.33	\$13.38
---------	---------------	---------	---------	---------

3M 908 Gold Acid Free ATG

3M® 908 is pressure sensitive acid-free adhesive. It is ideal for bonding acid-free boards and will not yellow, become brittle or lose adhesion. Can be used with 3M Scotch® (and similar type) ATG Applicators. 3M® 908 has a pH between 7.0 and 8.5. 

Item #	Size	1 Roll	12+Rolls@	72+Rolls@
--------	------	--------	-----------	-----------

3M908146	1/4" x 36 yds	\$ 6.73	\$ 6.07	\$ 5.85
3M90812	1/2" x 36 yds	\$ 9.29	\$ 8.63	\$ 8.34
3M90860	1/2" x 60 yds	\$14.94	\$13.64	\$13.08

Item #	Size	1 Roll	12+Rolls@	48+Rolls@
--------	------	--------	-----------	-----------

3M90834	3/4" x 36 yds	\$12.36	\$11.47	\$10.90
3M908346	3/4" x 60 yds	\$19.74	\$18.23	\$17.35

3M 987 ATG

3M™ 987 is a general purpose ATG for holding many paper, foils, films, and various foams. For use with 3M Scotch® (and similar type) ATG Adhesive Applicators. 

Item #	Size	1 Roll	12+Rolls@	72+Rolls@
--------	------	--------	-----------	-----------

3M98712	1/2" x 36 yds	\$ 3.13	\$ 2.84	\$ 2.69
3M98760	1/2" x 60 yds	\$ 4.94	\$ 4.60	\$ 4.16

Item #	Size	1 Roll	12+Rolls@	48+Rolls@
--------	------	--------	-----------	-----------

3M98734	3/4" x 36 yds	\$ 4.26	\$ 3.55	\$ 3.48
3M987346	3/4" x 60 yds	\$ 6.59	\$ 6.13	\$ 5.78



3M 700 ATG Applicator Gun

The 3M® 700 Applicator Gun is designed to hold all ATG rolls 1/2" - 3/4" wide and up to 60 yds. Covered gears minimize applicator jams and transparent cover shows remaining tape. Easy trigger controls application of tape. Applies ATG tape while simultaneously removing and rewinding the liner.

Item #	Description	Each	3 or more
--------	-------------	------	-----------

3M700	#700 Dispenser	\$56.75	\$54.05 each
-------	----------------	---------	--------------



3M 714 ATG Applicator Gun

The 3M® 714 Applicator Gun is designed specifically to hold 1/4" ATG rolls up to 60 yds. Covered gears minimize applicator jams. Transparent cover shows remaining tape.

Item #	Description	Each	3 or more
--------	-------------	------	-----------

3M714	#714 Dispenser	\$60.76	\$57.32 each
-------	----------------	---------	--------------



M&M

M&M ATG

M&M ATG Adhesive Transfer Tape is a quality acrylic general-use pressure sensitive adhesive on a strong acrylic paper liner, designed to fit 3M Scotch® (and similar type) ATG Adhesive Applicators.

M&M Regular ATG

2 mil • Medium Tack • Instant, permanent mounting

Item #	Size	1 Roll	12+@	72+@	216+@
--------	------	--------	------	------	-------

2350B	1/2" x 36 yds	\$3.18	\$2.78	\$2.64	\$2.51
2355A	1/4" x 60 yds	\$3.32	\$3.02	\$2.84	\$2.59
2355B	1/2" x 60 yds	\$5.29	\$4.63	\$4.46	\$4.27

Item #	Size	1 Roll	12+@	48+@	144+@
--------	------	--------	------	------	-------

2350C	3/4" x 36 yds	\$3.79	\$3.55	\$3.43	\$3.26
2355C	3/4" x 60 yds	\$8.37	\$7.58	\$7.05	\$6.32

M&M Economy ATG

1.6 mil • Low Tack • Instant, permanent mounting

Item #	Size	1 Roll	12+@	72+@	216+@
--------	------	--------	------	------	-------

2360B	1/2" x 36 yds	\$2.89	\$2.40	\$2.27	\$2.11
2365A	1/4" x 60 yds	\$2.94	\$2.47	\$2.27	\$2.16
2365B	1/2" x 60 yds	\$4.33	\$3.79	\$3.55	\$3.32

Item #	Size	1 Roll	12+@	48+@	144+@
--------	------	--------	------	------	-------

2360C	3/4" x 36 yds	\$3.62	\$3.06	\$2.92	\$2.76
2365C	3/4" x 60 yds	\$5.72	\$5.05	\$4.81	\$4.43

M&M Heavy Duty ATG

5 mil • High Tack • Instant, permanent mounting

Item #	Size	1 Roll	12+Rolls@	72+Rolls@
--------	------	--------	-----------	-----------

2370B	1/2" x 18 yds	\$3.32	\$2.99	\$2.84
2375B	1/2" x 36 yds	\$6.49	\$6.01	\$5.52

Item #	Size	1 Roll	12+Rolls@	48+Rolls@
--------	------	--------	-----------	-----------

2370C	3/4" x 18 yds	\$4.91	\$4.43	\$4.20
2375C	3/4" x 36 yds	\$9.46	\$8.84	\$8.34

M&M Hand-Applied ATG

Reverse wound for hand application, does not fit applicator guns. 2 mil 60 yd. roll • 3" Core
Medium Tack • Instant, permanent mounting.

Item #	Size	1 Roll	12+Rolls@	72+Rolls@
--------	------	--------	-----------	-----------

2380A	1/4" x 60 yds	\$4.33	\$3.79	\$3.55
2380B	1/2" x 60 yds	\$6.14	\$5.53	\$5.29

Item #	Size	1 Roll	12+Rolls@	48+Rolls@
--------	------	--------	-----------	-----------

2380C	3/4" x 60 yds	\$8.22	\$7.55	\$7.08
-------	---------------	--------	--------	--------



Items with this symbol "Ride Along" with your length or chop moulding order at no extra delivery charge.

California Customers- WARNING: Cancer and Reproductive Harm - www.P65Warnings.ca.gov

OMEGA
QUALITY FRAMING PRODUCTS

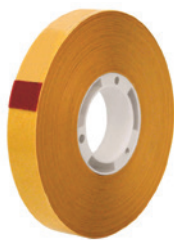

Omega ATG

Omega ATG is a quality acrylic general-use pressure sensitive adhesive on a strong acrylic paper liner, designed to fit 3M Scotch® (and similar type) ATG Adhesive Applicators.

Omega Regular ATG

2 mil • Medium Tack • Instant, permanent mounting
Comparable properties to 3M 924 ATG. 

Item #	Size	1 Roll	12+@	48+@	144+@
ATG1236	1/2" x 36 yds	\$2.18	\$1.97	\$1.81	\$1.69
ATG1260	1/2" x 60 yds	\$3.18	\$2.91	\$2.77	\$2.65



Omega SuperTack ATG

5 mil • High Tack • Instant, permanent mounting
Comparable properties to 3M 969 ATG. 

Item #	Size	1 Roll	12+@	48+@	144+@
ATGST36	1/2" x 36 yds	\$4.02	\$3.79	\$3.62	\$3.42



Omega True Blue Applicator Gun

The True Blue ATG Applicator Gun is a sturdy general-purpose frameshop workhorse. Holds rolls up to 36 yards and up to 3/4" width. 

Item #	Description	Each
T100	Blue ATG Applicator Gun	\$23.12



3M Scotch 810 Magic Tape

Mend it, seal it and secure it with this permanent transparent tape. Non-yellowing tape disappears when applied, and stays invisible over time. Though not for use on artwork, Scotch 810 tape has a variety of uses throughout the frame shop.

3/4" or 1" 72 yard roll 

Item #	Size	1 Roll	12+rolls
1081	3/4" x 72 yds • 1" core	\$6.46	\$6.15 each
1082	1" x 72 yds • 3" core	\$8.39	\$7.97 each



3M Scotch 811 Removable Tape

Temporarily secures mats and other items. Allows for repositioning without tearing. Easily removed and ideal for decorative mats. 

3/4" or 1" 72 yard roll

Item #	Size	1 Roll	12+rolls
3M81134	3/4" x 72 yds	\$7.36	\$6.99 each
1094	1" x 72 yds	\$9.39	\$8.90 each



3M 850 Polyester Clear Tape

3M Polyester Film Tape 850 can generally be used for splicing and applications where chemical resistance and/or clean removal is necessary. Backed with transparent polyester with a thin layer of aluminum. 1 in x 72 yd. Roll w/ 3" core.

Item #	Size	1 Roll	12+rolls
2018	1" x 72 yds	\$41.46	\$39.40 ea.



Acid Free Framing Tape

Polyethylene cloth tape made specifically for the acid-free matting and hinging of artwork. Will not stain artwork, leave residues, or deteriorate. Strong adhesion. User-friendly handtearable cloth. 

Item #	Size	1 Roll	6+rolls	12+rolls
4375D	1" x 20 yds	\$13.20	\$12.39 ea.	\$11.89 ea.
4375X	1" x 60 yds	\$20.72	\$19.48 ea.	\$18.67 ea.

Acid Free Plastic Framing Tape

Plastic tape made specifically for the acid-free matting and hinging of artwork. Will not yellow or stain artwork, deteriorate or leave residue. Strong adhesion to paper, mat boards, and foam board. 

Item #	Size	Each	6+Rolls	12+Rolls
4390	3/4" x 60 yds	\$16.72	\$15.89 ea.	\$15.09 ea.
4391	1" x 60 yds	\$20.88	\$19.83 ea.	\$18.84 ea.
4392	2" x 60 yds	\$38.51	\$36.19 ea.	\$34.66 ea.



Black Gaffers Tape

Great for lining shadowbox and mirror frames, project construction canvas edges and more! 2" wide flexible fabric tape with strong adhesion to fabric, wood, and paper. 

Item #	Size	1 Roll	6+rolls
T113	2" x 55 yds	\$28.93	\$26.03 each



Black Mirror Tape

Black tape to adhere inside rabbet to mask reflection of wood when framing mirrors. 

Item #	Size	1 Roll	12+rolls
T107	1/4" x 54 yds	\$5.05	\$4.80 each





Black Masking Tape

Quality black crepe masking tape in ¾" and 1" widths. 3" Core • 60 yard rolls.

Item #	Size	1 Roll	12+rolls
T106	¾" x 60 yds	\$3.47	\$3.15 each
3028	1" x 60 yds	\$4.13	\$3.72 each



Natural Crepe Masking Tape

Quality natural crepe masking tape in ¾", 1" & 1 ½" widths. 3" Core • 60 yard rolls.

Item #	Size	1 Roll	12+rolls
T102	¾" x 60 yds	\$1.56	\$1.38 each
T103	1" x 60 yds	\$2.06	\$1.85 each
1042D	1 ½" x 60 yds	\$3.47	\$3.21 each

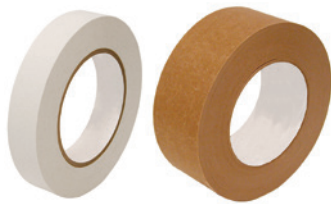

Flat Back Tapes

High quality flatback tape with natural rubber adhesive for good instant adhesion. Use for reinforcing packaging, splicing foamboard, or sealing backings. Easy tear, pressure sensitive. Available in White (1") and Kraft (¾", 1", 1 ½", 2") 3" Core • 60 yard rolls.

Item #	Size	Color	1 Roll	12+Rolls
T105	1" x 60 yds	White	\$ 6.71	\$ 6.33
T104	2" x 60 yds	Kraft	\$ 5.71	\$ 5.21
T117	3" x 60 yds	Kraft	\$10.26	\$ 9.56

Premium

1042E	¾" x 60 yds	Kraft	\$4.28	\$4.04
1042F	1" x 60 yds	Kraft	\$5.76	\$5.37
1042G	1 ½" x 60 yds	Kraft	\$8.76	\$8.33



PVC Tape

Pressure sensitive natural rubber based adhesive brown PVC tape used for packaging. Can be used in handheld tape guns for quick and easy dispensing. Meets U.S. Postal regulations. 3" Core • 60 yard rolls.

Item #	Size	1 Roll	12+Rolls	36+Rolls
1039B	2" x 60 yds	\$2.23	\$1.94 ea.	\$1.74 ea.



Framer's Tape II

Framer's Tape II

Framer's Tape II is an acid-free pressure sensitive tape used for hinging artwork and matboards. Highly regarded throughout the industry, this tape is thick and strong and can be removed with minimal heat without leaving adhesive residue. pH neutral, non-yellowing. 3" Core • 60 yard rolls.

Item #	Size	1 Roll	12+Rolls
T111	¾" x 60 yds • Framer's Tape II	\$7.83	\$7.05 each
T112	1" x 60 yds • Framer's Tape II	\$9.82	\$8.83 each

Stitchery Tape

Acid-free & solvent-free double-sided tape for stitchery mounting. It is safe for fabric; silk, linen, velvet and more. Adhesive will not bleed through or damage fabric.

Item #	Size	1 Roll	12+Rolls
T114	1 ½" x 36 yds • Stitchery Tape	\$12.03	\$11.42 ea.



White Artist Tape

This quality white flatback artist tape is pH neutral, allowing a wider range of use than utility grade flatback rubber adhesive tapes. Great for splicing foamboards, reinforcing fillets to boards, and more. ½", ¾", & 1" wide rolls. 3" Core • 60 yard rolls.

Item #	Size	1 Roll	12+Rolls
4375E	½" x 60 yds	\$4.02	\$3.80 each
4375B	¾" x 60 yds	\$5.95	\$5.64 each
4375C	1" x 60 yds	\$8.43	\$7.59 each



Filament Tape

Pressure-sensitive tape used for several packaging functions such as closing corrugated fiberboard boxes, reinforcing packages, bundling items, etc. Polyester film and fiberglass filaments embedded to add high tensile strength. Meets U.S. Postal regulations. 3" core.

Item #	Size	1 Roll	12+Rolls
2051	¾" x 60 yds	\$3.55	\$3.18 each



Box Sealing Tape

Commercial-grade packaging tape is ideal for general-purpose packaging applications. Can be used in handheld tape guns for easy dispensing. Meets U.S. Postal regulations. 1.6 mm thick • 3" Core

Item #	Size	1 Roll	12+Rolls	36+Rolls
T101	2" x 110 yds	\$2.38	\$2.29 ea.	\$2.07 ea.



Black Flocked Tape

Omega's exclusive flocked black tape is ideal for lining shadowboxes. Great for production work and easy to use, this high quality flexible felt tape adheres strongly to fabric, wood, and paper. Easy to cut, peel, and position. Comes in 36 ft. rolls in widths of 1", 1 ½", and 2". 3" core

Item #	Size	1 Roll	3 Rolls+
T108	1" x 36 ft.	\$10.22	\$ 9.20
T109	1 ½" x 36 ft.	\$14.43	\$12.99
T110	2" x 36 ft.	\$17.16	\$15.45



Scotch P56 Mainline Tape Dispenser

Scotch® Mainline Dispenser P56 features a weighted base for stable dispensing holding tapes, or a combination of tape rolls, up to 6 inches wide.

Item #	Description	Each	
2054	P56 Mainline Dispenser	\$98.39	



Side Mounted Tape Dispenser

Side mounted tape dispenser can be mounted on work table edges, or any perpendicular surface. Sturdy metal mounting bracket and cutting edge.

Item #	Description	Each	3 or More
2053	Side Mount Dispenser	\$18.53	\$17.86 each



Filmoplast P-90

Filmoplast P-90 is a self-adhesive white paper tape perfect for hinging artwork. The long-fibered material makes it durable and tear-resistant and provides a secure means to hinge even larger artwork.

Filmoplast P-90 Plus

P-90 Plus is specifically designed for fine art hinging. The adhesive used is a refined version of the original providing better initial as well as final bond strength while retaining the same stable aging characteristics. Both the adhesive and paper are buffered (pH 8.7 aged) so the tape remains acid-free for decades.

Item #	Description	Each	3 Rolls+
N25223	P90 • ¾" x 164ft.	\$22.02	\$21.14 ea.
N6018639	P90 Plus • ¾" x 164ft.	\$24.66	\$23.67 ea.



Filmoplast SH

When the application calls for exceptional strength Filmoplast SH is the answer. Made from an very fine threaded white linen fabric this tape is coated with a high tack acrylic adhesive that bonds well to a variety of surfaces. Professional picture framers use Filmoplast SH to hinge or "book" the window mat to the backboard keeping the two in perfect registration. Filmoplast SH can also be used in conjunction with Filmoplast P 90 to create a high strength art hinge. In this application the Filmoplast SH is used as the cross piece attached to the backing board and Filmoplast P 90 holds the art.

Item #	Size	Each	3 Rolls+
N25124	1¼" x 82 ft.	\$24.22	\$23.54 each



Lineco Gummed Paper Hinging Tape

The high tensile strength of this quality, water activated hinging tape will support all but the heaviest works of art. The paper is acid-free with a calcium carbonate buffer and a pH of 8.5. The neutral pH adhesive has excellent tack to hold firmly without slipping or "creeping".

Item #	Size	Each	3 Rolls+
1710	1" x 130 ft.	\$7.32	\$6.73 each

Lineco Abaca.sa Hinging Tape

Abaca.sa self-hinging tape incorporates the strength and supple nature of Abaca paper (manila hemp), along with a very strong acrylic adhesive that is permanent and non-yellowing. Gummed tapes are risky to use with Giclee inkjet prints because of their water sensitivity. In these cases a self-adhesive tape is a much safer alternative. Abaca.sa is strong enough to hold large digital prints, and supple enough to adhere to the print without distorting. Abaca paper is acid-free, biodegradable, and comes from a self-sustaining plant.

Item #	Size	Each	3 Rolls+
L5330754	7/8" x 150 ft.	\$16.05	\$14.68 each

Lineco Mulberry Hinging Tape

High quality, strong, weight (52 gsm), Japanese paper offered in convenient rolls of 1" x 100 ft. For use with wheat/rice starch or methyl cellulose homemade paste. For a non-adhesive mousing method, paper slings or paper photo corners are simple to make and adhere with archival tapes.

Item #	Size	Each	3 Rolls+
L5330756	1" x 100 ft.	\$10.71	\$ 9.64 each



Lineco Self-Adhesive Hinging Tissue

This pressure sensitive, mounting/hinging tissue is a fine, long fibered tissue with an archival quality pressure sensitive acrylic adhesive that is permanent and non-yellowing. Ideal for hinging translucent art such as Japanese paper, papyrus, and other light weight art because it won't show through.

Item #	Size	Each	3 Rolls+
L5330125	1" x 35 ft.	\$ 9.14	\$ 8.37 each
1720	1" x 98 ft.	\$16.21	\$14.97 each

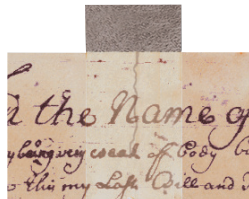

Lineco Document Repair Tape

This very thin and extremely transparent pressure sensitive document repair tape is non-yellowing, removable with solvents, and has a neutral pH. To use, dispense a length of tissue, place over the tear, and burnish with a bone folder. Working the adhesive into the tear causes the adhesive to strengthen the tear as well as cover and support the area around the tear. It has been thoroughly tested and approved by numerous government agencies and is a favorite of both conservators and collectors.

Item #	Size	Each	3 Rolls+
L9010198	1" x 35 ft.	\$ 8.68	\$ 7.81 each
L5330198	1" x 98 ft.	\$17.04	\$15.34 each



Lineco Self-Adhesive Linen Hinging Tape

Lineco's Self Adhesive Linen Hinging Tape is an excellent choice for hinging window mats and photos. It's a non-yellowing, pressure sensitive adhesive. Coated with a neutral pH acrylic adhesive of archival quality, the tape has a high thread count and a release liner paper. The linen is a favorite for hinging window mats to backboard or attaching art. The very fine linen cloth is flexible yet strong.

Item #	Size	Each	3 Rolls+
L5331015	1¼" x 35 ft.	\$12.17	\$11.22 each
1715	1¼" x 150 ft.	\$31.83	\$28.81 each



Lineco Gummed Linen Hinging Tape

This water activated tape, with 65/55 thread count fabric, provides superior strength for hinging, mounting or repair applications. The neutral pH adhesive has high tack, lay flat properties that make it a favorite for hinging mats and heavy pieces. Available in 1" x 150' or 1" x 300' rolls.

Item #	Size	Each	3 Rolls+
L5331025	1" x 30 ft.	\$10.82	\$ 9.73 each
L5331050	1" x 150 ft.	\$29.25	\$26.31 each
1711	1" x 300 ft.	\$51.12	\$46.02 each



Lineco Transparent Mending Tissue

This very thin and extremely transparent pressure sensitive archival mending tissue is non-yellowing, removable with solvents and has a neutral pH. To use, dispense a length of tissue, place over the tear and burnish with a bone folder. Working the adhesive into the tear causes the adhesive to strengthen the tear as well as cover and support the area around the tear.

Item #	Size	Each	3 Rolls+
1740	½" x 50 ft.	\$ 6.99	\$ 6.43 each





Lineco Archival Mounting Corners

Pressure sensitive Archival Mounting Corners virtually disappear on the page, yet hold your artwork firmly in place. See-thru Archival Corners simply press into place and feature a safe acrylic adhesive backing. Use in conservation mounting applications of photographs, prints, and other 2-dimensional artwork. 

Item #	Description	Qty. Each	1 Pack	3+@
1704	5/8" Photo Corner	500	\$ 6.53	\$ 5.80
1705	1/2" Photo Corner	240	\$ 6.99	\$ 6.51
1706	1 3/8" Mounting Corner	240	\$ 13.36	\$ 12.24
L5330034	1 1/4" Standard Poly Corner	250	\$ 12.87	\$ 12.23
L5330035	1 1/4" Full View Poly Corner	250	\$ 14.77	\$ 13.43
5330038M	1 1/4" Slimline Poly Corner	72	\$ 9.08	\$ 8.18
L5330036	3" Standard Poly Corner	100	\$ 13.70	\$ 12.34
L5330037	3" Full View Poly Corner	100	\$ 14.27	\$ 13.03



Lineco Archival Mounting Strips

Use these mounting strips for safe, hingeless mounting of artwork to mats. Made from conservation quality Archival Polyester and acid-free paper with a self adhesive backing strip. Simply position the print or photograph in place and adhere strips to the mat. No adhesive ever comes in contact with the artwork. Instead, the art is cradled by inert archival polyester and is ready to be framed.

Item #	Description	Qty. 1 Pack	3+@
L5334015	1"x4" Archival Strips	60	\$ 11.80 \$ 10.78
1701	1"x12" Archival Strips	60	\$ 28.50 \$ 26.30



Lineco pH Testing Pen

Distinguish between safe alkaline paper and board, and unsafe acidic paper and board. The chlorophenol red indicator solution turns a definite purple color on any paper with a pH of 6.5 or higher. 

Item #	Description	1 Pen	3 or more
1130	Lineco pH Testing Pen	\$6.24	\$ 5.49 each



Lineco Frame Sealing Tapes

The white and gray frame sealing tape is designed specifically to seal backing board to frames. This pressure sensitive tape attaches firmly to almost any surface and conforms well to most surface irregularities. Manufactured from Lineco's exclusive Perma/Seal label stock with a foil layer, a non-yellowing, permanent acrylic adhesive and coated to match Lineco's Frame Backing Paper (sold separately). Also provides an effective barrier for the rabbets of wood frames. 

Item #	Description	1 Pack	3+@
L3870151	1 1/4" x 85 ft. • Gray	\$ 10.64	\$ 9.72
1731	1 1/4" x 85 ft. • White	\$ 9.78	\$ 9.02

Copper I-Film Corrosion Intercept

Features a polyethylene embedded with a copper matrix which is coated with an acrylic adhesive. It is flexible, strong and puncture resistant for easy application. Helps retard acids, corrosive gases, and resists mold and mildew. Strong adhesive sticks to raw wood. 

Item #	Description	1 Pack	3+@
L0342000	1 1/4" x 85 ft. • Copper	\$ 18.57	\$ 16.97



Lineco Neutral pH Adhesive

A white, neutral pH adhesive made of archival polyvinyl acetate (PVA), Lineco Neutral pH Adhesive is ideal for artistic creations such as collages and bookbinding, and for adhering mats and objects within a frame. This adhesive has excellent "lay flat" properties, dries clear and fast, it won't become brittle with age, and it's remoistenable with water. 

Item #	Description	Each	3 or more
1745	8 fluid oz. Bottle	\$ 5.82	\$ 5.38 ea.

Lineco Methyl Cellulose Adhesive

A neutral pH, water reversible adhesive that dries clear. Use for repair, gluing end sheets and general archival adhesive applications.

Item #	Description	1 Pack	3+@
L7931001	1.5 oz. bottle	\$ 7.79	\$ 7.01

Lineco Wheat Starch Adhesive

A very carefully purified, uncooked food-grade wheat starch. When cooked, it makes a superior smooth wheat paste adhesive.

Item #	Description	1 Pack	3+@
L6151002	2 oz. bottle	\$ 6.02	\$ 5.42

Lineco Rice Starch Adhesive

Similar to wheat starch, but it yields a lighter, thinner starch adhesive paste after cooking.

Item #	Description	1 Pack	3+@
L6151502	2 oz. bottle	\$ 8.59	\$ 7.74

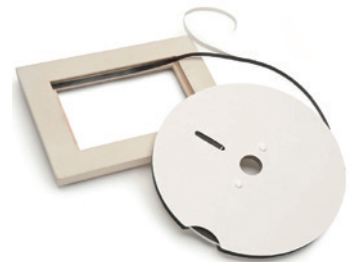

Lineco Volara Foam Rabbet Tape

This inert, .0313" thick foam tape features an aggressive acrylic adhesive for lining frame rabbets. Protects canvas transfers, digital media and other forms of art by providing a cushion. 

Item #	Description	1 Roll	3+Rolls
L0181436	1/4" x 36 yds./0.0313 thick	\$ 16.18	\$ 14.79 ea.



Lineco Frame Backer Paper

Use this attractive paper to add value and differentiate your museum quality framing jobs. This acid-free buffered paper won't harm the art and won't puncture like everyday brown or black kraft paper. Moderate porosity allows the frame package to breathe. 40 lb. paper weight. 36" x 300 ft. roll

Item #	Size	1 Roll	3+Rolls
L6130037	36" x 300 ft. Roll	\$ 83.19	\$ 79.03 each



Lineco Tyvek Frame Backing Paper

A unique frame backing material that is acid-free and contains no damaging chemicals that can affect framed artwork. Tyvek is easily cut and worked like traditional paper frame backing material, yet is puncture and moisture resistant and won't attract insects. (White, 36" x 70 yd. roll) 

Item #	Size	1 Roll	3+Rolls
1723	36" x 70 yd. Roll	\$ 178.47	\$ 169.55 each



D&K Expression Fusion 4000 Acid-Free Dry Mounting Tissue

Fusion 4000 Adhesive is an ultra-clear, removable, thermal-activated, 100% inert, pure adhesive film that can conform around free-form shapes. Can be overlapped. Great for mounting lithographs, newsprint, photographs (fiber-based and RC), photostats, art papers, engravings, silks, canvas and foils; also ideal for textured surfaces and fabrics. Fusion 4000 is acid-free; mounted work can be removed by reheating, with extreme care especially with delicate media. Adhesive activates at 170 degrees Fahrenheit. Bonds in under 2 minutes.

Item #	Size	Each
3064	20" x 30 yds.	\$ 86.40
3066	32" x 30 yds.	\$121.25
BF356	24" x 30 yds.	\$ 83.29
BF358	40.5" x 30 yds.	\$130.39

D&K Expression ColorMount Dry Mounting Tissue

Colormount Dry Mounting Tissue is a porous tissue coated on both sides with a low temperature adhesive that bonds while hot. Permanently bonds at 185° Fahrenheit. Specially formulated for permanent, low-temperature dry-mounting of RC photographs. It's also an excellent general-purpose adhesive for most other mounting applications, including slick poster materials, blueprints, lithographs and other smooth artwork. Works well with almost all mounting substrates: cardboard, foam boards, Masonite, aluminum and Plexiglass.

Item #	Size	Each
BF614	24.5" x 50 yds.	\$150.13
BF618	40.5" x 50 yds.	\$244.63
3046	36" x 50 yds.	\$264.79
3046A	36" x 100 yds.	\$435.71
3047A	40.5" x 100 yds.	\$506.10

Item #	Description	Each
3049	11" x 14" (100 Sheets)	\$ 82.67



D&K RagMount Dry Mounting Tissue

Ragmount® Tissue (Film) is a 100% breathable tissue for today's modern digital prints. The benefit of this breakthrough tissue is that it prevents air from becoming trapped inside the film that can cause bubbles. The bond is very secure and safe for long-term mounting. The adhesive is acid free and solvent free, applied on 100% cotton rag tissue.

Item #	Description	Each
BFA435	Ragmount 24.5" x 150'	\$165.30
BFA436	Ragmount 40.5" x 150'	\$273.99

D&K Buffermount Dry Mounting Tissue

BufferMount® is a very versatile and safe acid-free adhesive tissue. It is coated on both sides with a low-temperature (170° F), inert acrylic adhesive that melts during heating, bonds as it cools and is removable when reheated.

Item #	Description	Each
3036A	Buffermount 24.5" x 90'	\$100.12
3037A	Buffermount 40.5" x 90'	\$147.24

D&K Double-Sided Release Paper

High quality non-stick silicone paper, evenly coated on both sides, to prevent adhesion and reduce residue build up on the heat press platen. The heavy weight 60 lb paper performs well as a protective overlay for maintaining the even texture of your mounted subject matter and can be used multiple times due to its strength and coating.

Item #	Description	Each
BF929	26" x 60' Roll	\$ 66.21
BF934	42" x 90' Roll	\$159.85

D&K Single-Sided Release Paper

Release paper silicone coated on one side for use as a protective overlay when dry mounting in a heat or vacuum press. Single sided release paper is used as a carrier sheet when tissues are being laminated and as a protective layer when applying localized heat using a tacking iron.

Item #	Description	Each
BFA490	42" x 90' Roll	\$147.19

D&K Silicone Coated Release Board

Coated with silicone on each side, Bienfang release boards protect your projects during heat mounting and keep adhesive residues off of the press platen. Sturdy and reusable, these boards flatten rolled papers while securing your materials while mounting. 32"x40", 5 boards per pack.

Item #	Description	Each Pkg.
BF938	5 ct. 32" x 40" Release Boards	\$71.99



VistaMount Dry Mounting Tissue

VistaMount is a terrific all purpose dry mounting tissue, as well as a budget-friendly staple for your frameshop. VistaMount is a white heat activated tissue with a buffered paper core that provides a strong permanent bond. Adhesive activates at a cool 170-190 degrees in 1-2 minutes.

Item #	Description	Each
2071A	VistaMount 24.5" x 150'	\$ 96.40
2071C	VistaMount 24.5" x 328'	\$240.38
2071B	VistaMount 40.5" x 150'	\$155.40
2071D	VistaMount 40.5" x 328'	\$330.06

Flobond Acid-Free Dry Mounting Film

Flobond is 100% adhesive, having no core tissue whatsoever. This allows for great ease of use as the adhesive melts seamlessly onto the substrate, the material can be overlapped or patched. This is a pH neutral adhesive, and can be reversed by reheating. Bonds at 175-200 degrees Fahrenheit in 1-2 minutes. Great for mounting a variety of papers and flexible materials. 90' ft. rolls.

Item #	Description	Each
1441	FloBond 24.5" x 90'	\$ 83.60
1443	FloBond 40.5" x 90'	\$142.92

TriMount Dry Mounting Tissue

TriMount is a premium quality multipurpose breathable dry mounting tissue that is permanent and non-reversible. Coated on both sides of the tissue with a pH neutral adhesive which bonds at 185-212 degrees in 1-2 minutes. TriMount is recommended for mounting resin coated (RC) photographs, posters, and prints.

Item #	Description	Each
1422	TriMount 25.5" x 150'	\$125.46
1423	TriMount 25.5" x 300'	\$216.50
1426	TriMount 41" x 150'	\$194.89
1427	TriMount 41" x 300'	\$368.87



Omega Permanent Bond Tissue

Comparable to ColorMount Dry Mounting Tissue, Omega presents a quality dual-sided porous, breathable heat-sensitive adhesive tissue. Adhesive permanently bonds at a low 180-degrees. Ideal for standard papers, RC photographs, watercolor papers, silk, polyester, fabric, foamboard and gatorboard, ink jet papers, and much more.

Item #	Size	Each	3 Rolls@
OT401	24.5" x 150'	\$ 76.86	\$ 69.17
OT403	40.5" x 150'	\$115.76	\$104.19
OT406	40.5" x 300'	\$220.47	\$198.42

Omega Acid-Free Clear Tissue

Compares to FloBond, pH neutral bonds at 175-200°.

Item #	Size	Each	3 Rolls@
OT418	24.5" x 90'	\$ 46.64	\$ 41.96
OT419	40.5" x 90'	\$ 68.79	\$ 61.91



Silicone Release Paper

This silicone-treated paper can be used as a cover sheet in most dry mounting and laminating jobs. Seal Release Paper protects both the press and the materials from any adhesive overhang. Reusable.

Item #	Description	Each
3056	26" x 15' Roll	\$ 39.19
3058	34" x 90' Roll	\$142.34



Silicone Coated Release Board

Seal release board is smooth thin cardboard coated with silicone on both sides. They are extremely durable, reusable and easy to handle. Release Boards protect your artwork and keep your press platen clean. They are ideal for holding curled materials flat, while preventing "platen lines" on oversized work mounted in any heat press. Precut to size.

Item #	Description	Each Sheet
3079	40" x 60" Release Board	\$25.78

OMEGA⁺

Omega Double-Sided Release Paper

Omega's double-sided release paper is a smooth, white paper coated with silicone on each side. Recommended for use as a protective overlay/cover sheet for projects which also protects the dry mount press platen from any overhang of adhesives. Due to its silicone coating, one sheet can be re-used many times. 

Item #	Description	Each	3 Rolls@	6+Rolls@
OT415	34" x 90' Roll	\$107.88	\$ 92.46	\$ 82.19
OT416	42" x 90' Roll	\$132.23	\$113.33	\$100.74

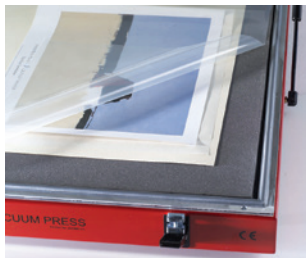

Omega Silicone Release Film

Omega's release film is a high quality non-stick crystal clear polyester film that allows see-through inspection of the mounting process. Silicone coated on both sides, this ultra-durable film is stronger and more flexible than release paper and is an ideal choice for vacuum heat presses.

Item #	Description	Each
1486	41" x 82 ft. Roll	\$ 111.91



DRYTAC[®]

ArtShield UV Laminating Films

Optically clear, vinyl based heat activated lamination films are an economical mounting solution that can be applied quickly and easily with any heat press or hot roller laminator. The adhesive coating is initially low-tack, allowing for removal or repositioning prior to final mounting. pH neutral adhesive has UV absorbing properties making them ideal for prints, posters, photos, etc.

ArtShield Matt:

ArtShield Matt™ UV (3.0mil) is a HeatSet™ PVC (vinyl) laminating film that offers a soft non-glare matte finish without sacrificing any color detail. 41" x 50' roll

Item #	Description	Each	
1464	41" x 50 ft. Roll	\$143.69	

ArtShield Mattex:

ArtShield Mattex™ UV (3.0mil) laminating film is ideal for laminating canvas mounted photographs. When provided with adequate dwell time, temperature and pressure, Mattex film will take on the texture of the canvas for a beautiful textured finish.

Item #	Description	Each	
1371	41" x 300 ft. Roll	\$626.69	

ArtShield Satinex:

ArtShield Satinex™ UV enhances posters, digital prints and photographs. Popular applications include laminating fabrics, canvas, and raised surfaces such as leaves and dried flowers. Satinex has a semi-gloss finish and provides excellent UV protection.

Item #	Description	Each	
1452	41" x 50' Roll	\$129.95	

ArtShield Linentex:

ArtShield Linentex™ UV (5.0 mil) is a PVC (vinyl), HeatSet™ laminating film with an embossed linen-like finish. The textured non-glare finish of ArtShield Linentex UV is ideal for framed portraits, diplomas and certificates.

Item #	Description	Each	
1375	51" x 50 ft. Roll	\$186.91	



D&K *Expression* (Formerly Bienfang)

D&K Expression

Finish Guard UV Laminating Films

Finish Guard UV Films protect the surface of prints, posters, etc, from moisture, dust, and fingerprints. The protective film adheres directly to the front surface of the item being laminated. The process is non-reversible. The film is a paper carrier with grid lines, and is coated with a very low tack adhesive to aid initial positioning. Stronger adhesive is heat activated during the lamination process. This film is pre-pierced to prevent air bubbles and for ease of use. These overlaminating films feature ultra violet protection coatings and a low bonding point of 200 degrees - for one to three minutes in a mechanical press - longer for vacuum and roller presses. These overlamination films are ideal for use with ink jet and other heat sensitive media. They are optically clear, durable, and light weight.

Finish Guard Satin Matte:

Satin Matte provides a soft, non-reflective surface for an even low-gloss satin finish. 41" x 50' roll

Item #	Description	Each	
1320	25" x 50' Roll	\$ 99.29	
BF1306	41" x 50' Roll	\$133.79	

Finish Guard Canvas:

Finish Guard Canvas gives posters, prints, and photographs the rich texture of artist's canvas with a soft sheen. 41" x 50' roll

Item #	Description	Each	
BFH1671	41" x 50' Roll	\$165.19	



D&K Foam Overlay for Laminating Materials

Specifically designed for the lamination process. Reusable, high density, heat resistant gray foam rubber sheeting, used to protect mounted surface during mounting, allows air and moisture to escape, and provides a uniform padded surface to yield consistent blemish-free results.

Item #	Size	Each
BF1309	42" x 8.5 ft.	\$40.79



Bienfang Perforator

Hand held 5 wheel piercing tool used to create tiny perforations for the release of hot air. Prevents the formation of air bubbles with non-perforated dry mount tissues, especially when mounting non-porous papers or RC Photos. 

Item #	Description	Each
1256	Bienfang Perforator	\$162.69

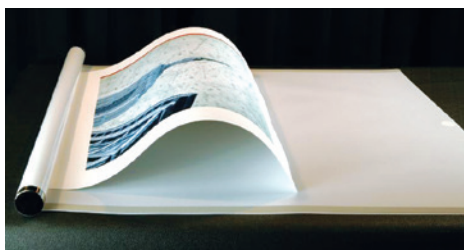

D&K De-Roller

This first-of-its-kind tool takes the curl out of rolled prints, posters, and fine art. This accessory provides an ingenious solution to an age-old problem and takes only minutes to do. 

- Item **3083** : 50" x 38", 1½" diameter to uncurl smaller size prints • \$350.77 each

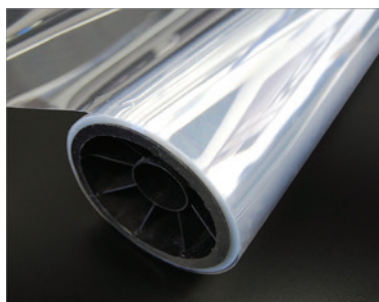

Archival Encapsulation Film

Preserve intact documents, photos, newspapers, artwork or collective treasures by encapsulating them between two sheets of film. The ultra-clear film is UV resistant and acid free. Apply the archival grade double sided tape (1/8" away from article) to one sheet of film. Remove liner from adhesive and place second sheet of film on top. Burnish edges to bond, and trim excess film and tape. Your treasure is secure and protected. This will leave your article in its original state and allow for framing or archival storage. 

Item #	Description	Each
1729	40" x 25 ft. Roll	\$ 66.18
4040	42" x 100 ft. Roll	\$102.24
4042	42" x 500 ft. Roll	\$398.63



Scotch Positionable Mounting Adhesive

Dry mount projects without heat, sprays, or odors. No machine required. Allows repositioning before permanent bonding. Formulated for sensitive papers and colors that can't hold up to heat, as well as thin papers and digital printouts. Convenient application, every time, anywhere. For professional artists and framers for mounting, paste-up work, laminating, burnishing, and matting. 

Item #	Description	Each	3 or more
1085A	11" x 50 ft. Roll	\$ 47.97	\$ 45.90 each
1085B	16" x 50 ft. Roll	\$ 67.64	\$ 65.01 each
1085C	24" x 50 ft. Roll	\$100.84	\$ 96.76 each



Black Baron Tacking Iron

The Black Baron tacking iron features an adjustable temperature dial, letting you control temperatures that range from 150°F up to 475°F. Thermostatically controlled; just dial thermostat to desired setting to maintain even and constant heat. Non-stick coating ensures long-life use and allows iron to glide over your protective cover sheet without scratching. Metal wire stand included. 5.5' AC power cord. 

Item #	Description	Each
TACKIRON	Black Baron Tacking Iron	\$39.63



21st Century Adjustable Tacking Iron

Advanced built-in solid-state thermostat maintains heat within 3° of dial setting. Temperature range of 150 to 410°F. Unique iron with dial on the handle for controlling temperature without touching the heated shoe. Indicator light will blink when the iron reaches the desired dialed-in temperature. 100% blackstone shoe coating resists scratches & adhesive buildup. Metal wire stand and cotton iron sock included. 5' AC power cord. 

Item #	Description	Each
ADJIRON	21st Century Tacking Iron	\$66.09

D&K Tacking Iron

Get professional results with the D&K tacking iron, designed for use by photographers, picture framers and conservators. Teflon coated surface prevents sticking while the pointed shoe design allows tacking in small corners. The new preset self-regulating control assures safe operation and long life. 

Item #	Description	Each
4023A	D&K Tacking Iron	\$79.47





3M Vac-U-Mount Spray Adhesive

Formulated for use with a vacuum press for mounting works on paper and fabrics. Bonds permanently without discoloration, cracking, or bleed through. Requires no heat. Extended open time (up to 10 minutes) allows you to spray and bond even the largest materials. 

Item #	Description	Each	12+ Cans
3MVUMS	15.25 oz. can	\$28.05	\$27.24 each



3M Hi-Strength Spray Adhesive 90

A very strong, fast-drying, contact-like adhesive, 3M™ Hi-Strength 90 Spray Adhesive is ideal for bonding heavy duty materials such as foam board, acrylic, heavy fabrics, gator-board, metal and more. 

Item #	Description	Each	12+ Cans
3MS90	17.6 oz. can	\$26.13	\$24.83 each



Sprayway Fast Tack 87 Adhesive Spray

Fast Tack 87 General Purpose Mist Adhesive is a high performance mist adhesive used for both temporary and permanent bonds. It is a versatile general purpose adhesive ideal for use in mounting fabrics to many substrates, bonding decorative papers, etc. Non-staining formula makes it suitable for use on a great variety of projects. 

• Comparable to 3M 77

Item #	Description	Each	12+ Cans
SP87	13 oz. can	\$9.62	\$8.64 each



3M Super 77 LOW VOC! Spray Adhesive

3M™ Super 77™ Multipurpose Adhesive is an extremely versatile, fast-drying adhesive that bonds a wide range of lightweight materials. Its fast, aggressive tack and low soak-in make it ideal for projects all around your home or business. It forms strong bonds with everything from paper, cardboard, fabric and cushion foam to plastic, metal, wood and more.

Regarding clogged nozzles on spray adhesive cans such as 3M Super 77: We occasionally get calls from customers that their cans of spray adhesive worked only for a short time; where there is adhesive left in the can but does not come out when the nozzle is depressed. This is a common issue caused by not cleaning the nozzle after each use.

3M directions: After each use, invert the can and depress the nozzle until no adhesive comes out. This will clear the nozzle of the adhesive that will cause any clogging. 3M also recommends removing then cleaning the clogged nozzle with adhesive remover or acetone, or take a nozzle from another can to try on the clogged can.

Item #	Description	Each	12+ Cans	72+Cans
3MS77	18 oz. can	\$18.31	\$17.40 ea.	\$17.19 ea.



Sprayway Fast Tack 89 Specialty Adhesive

A pressure sensitive mist adhesive intended for use for lightweight temporary bonds and repositionable applications. This adhesive has no permanent bonding capability. It has fast aggressive tack and good shear strength. When allowed to properly tack, the adhesive will not stain or transfer to other surfaces. 

• Comparable to Spraymount

Item #	Description	Each	12+ Cans
SP89	13 oz. can	\$9.01	\$8.11 each



Elmers Repositionable Mounting Spray

Repositionable mounting spray will stick and re-stick over and over. It provides a light tack in seconds and dries fast and clear. Specially formulated for repositionability or temporary bonding on a single surface. Ideal for use with project where short term adhesion is needed. Use on paper, foil, cork, metal, wood, films, felt, foams, fabrics, leather, glass, plastics and more. 

Item #	Description	Each	12+ Cans
BFE454	10 oz. can	\$11.40	\$10.83 each



Elmers Extra Strength Spray Adhesive

Acid-free and photo safe. Permanent bond when dry. Fast tack - dries clear. Extra Strength formulation for mounting items to a variety of surfaces, including plastics, photos, fabrics, paper, foil, cork, metal, wood, films, felt, foams, canvas, leather, glass, cardboard, and foam rubber. Sprays wide to cover large areas. Resists "bleed-through". 

Item #	Description	Each	12+ Cans
BFE456	10 oz. can	\$7.77	\$7.39 each



BOSS Silicone Sealant Spray Adhesive

Unique spray application is designed to ensure adhesive stays workable. Superior adhesion to wood, metal, concrete, or glass. Dries to a flexible, rubbery solid. Will not chip, crack, shrink, dry out, or discolor. Sets in 2 hours, fully cures in 24 hours. 

Item #	Description	Each	6+ Cans	12+Cans
1045	8 oz. can	\$15.78	\$14.97 ea.	\$13.72 ea.



Miter Magic™ Polyvinyl Glue

Special formulation makes Miter Magic the strongest glue for joining wood frames available in the industry. Glue dries fast and clear and is water soluble for easy cleanup and handling.

Item #	Description	Each	4 or more
GL100	1 Pint Bottle	\$11.01	\$ 9.91 each
GL200	1 Gallon Bottle	\$49.86	\$44.89 each



Same formula as Miter Magic

Black Magic™ Black Polyvinyl Glue

Black Magic black polyvinyl glue is a great solution for joining black/dark mouldings. Dries fast and is water soluble for easy cleanup and handling.

Item #	Description	Each
GL300	1 Pint Bottle	\$11.01
GL350	1 Gallon Bottle	\$50.70



Framer's Glue
Pint • GL500

Framer's Glue
Gallon • GL600

Mounting Glue
Gallon • GL400

Framer's Glue™ Polyvinyl White Glue

Framer's Glue is a general purpose economy polyvinyl glue with a thinner viscosity to allow its use in a wide array of projects and can be used in automatic glue applicators. Dries fast and clear and is water soluble for easy cleanup and handling.

Item #	Description	Each	4 or more
GL500	1 Pint Bottle	\$ 8.76	\$ 7.89 each
GL600	1 Gallon Bottle	\$48.38	\$45.96 each

All Purpose Mounting Glue

Premium quality, pH neutral, acid free, water soluble mounting adhesive for use in cold vacuum mounting presses or when mounting by hand. Can be applied easily by roller, spray gun, or brush.

Item #	Description	Each	4 or more
GL400	1 Gallon Bottle	\$34.35	\$30.91 each



Corner Weld™ Polyvinyl Glue

This strong bonding all-purpose glue is perfect for all wood frames in addition to many other jobs throughout the frame shop. Dries clear, cleans up with water, and has a long shelf life.

Item #	Description	Each	4 or more
9100	1 Pint Bottle	\$10.89	\$ 9.99 each
9101G	1 Gallon Bottle	\$57.32	\$51.59 each



VacuGlue 300

VacuGlue 300 is a natural vegetable starch based adhesive that is pH neutral (acid free), water soluble, odorless, and freeze-thaw stable. It may be applied with a brush, roller, or spray gun, and sets quickly with either a vacuum press, dry mount press, or a rubber brayer. The bond is unaffected by changes in temperature and humidity, and remains reversible at all times. Contains no solvents and cleans up easily with water.

Item #	Description	Each
BF461	64 oz. Bottle	\$33.57

Kool Tack Adhesives

• Maxim Blue Wood Glue

One-minute bond time, sets up in 15 minutes, cures in 3 hours, dries clear, water cleanup. This glue was formulated to bond large picture frame corners without using nails.

• Dust Cover Adhesive

Newest technology in dust cover adhesive. No need to use double sided tape to affix dust covers to frames or to adhere two frames together. Unlike the old glues, this product is easily removable. Remove dust covers with a damp cloth!

Item #	Description	Each
MAX64	64 oz. Wood Glue	\$27.51
MAX128	128 oz. Wood Glue	\$46.31
DC-4	4.5 oz. Dust cover adhesive	\$ 6.56
DC-16	16 oz. Dust cover adhesive	\$10.97



UnStik® Adhesive Release

Special adhesive releasing solvent used to remove artwork from various mounting adhesives. It can also be used to clean adhesive residue off artwork or press parts. *Can not ship UPS due to hazmat regulations.*

Item #	Description	Each	6 or more
BF470	1 Quart Can	\$29.20	\$26.28 each



MITER FUSION™

Safer than MEK Formula!

Miter Fusion™ Glue for Polystyrene Moulding

This acrylate adhesive is environmentally safe, containing no V.O.C.s. Specially formulated for polystyrene and other plastic mouldings. Safer to use than traditional styrene glues. Extremely fast drying & quick setting.

Item #	Description	Each	4 or more
GL700	8 oz. Bottle	\$33.81	\$30.43 each
GL800	16 oz. Bottle	\$66.50	\$59.84 each



Professional Fabric Adhesive

Ideal for almost any fabric, fine, or heavy, this fabric adhesive is well suited for creating fabric mats and custom fabric liners with moulding. Can be applied evenly and easily by hand with roller (on flat surfaces) or brush (on mouldings). Water soluble when wet, making for easy handling and clean up and water resistant when dry for durability.

Item #	Description	Each
1026B	1 Gallon Bottle	\$29.37



Un-du® Adhesive Remover

Safely removes all self-sticking & pressure sensitive stickers, tapes, labels and adhesives on contact. Acid free and photo safe, leaves no residue or staining after evaporation.

Item #	Description	Each
3017	4 oz. Bottle	\$ 8.59
3019	32 oz. Bottle	\$19.17





Braided Picture Wire

High quality braided picture hanging wire is made of heavy duty pliable galvanized steel. 5 lb. spools

Available in 6 gauges:	Approx. Ft. Per Spool
WPB201 • #2 12 lbs. max picture weight	1500 ft.
WPB301 • #3 16 lbs. max picture weight	1025 ft.
WPB401 • #4 20 lbs. max picture weight	910 ft.
WPB501 • #5 24 lbs. max picture weight	740 ft.
WPB601 • #6 28 lbs. max picture weight	650 ft.
WPB801 • #8 36 lbs. max picture weight	500 ft.

Each	3 Spools	6 or more
\$20.52	\$18.26 each	\$17.14 each

> Sizes can be mixed for price break



Easy-Fit® Nylon Coated Stainless Steel Wire

Easy-Fit is a new ultra-flexible nylon coated stainless steel picture framing wire that framers love. Easy-Fit is smooth and ouchless (easy on the fingers!), and is easy to wrap or knot. Special coating makes Easy-Fit kink-free, leaves walls unmarked, and easily adjusts on wall hangers. 

Available in 6 gauges:	Approx. Ft. Per Spool
WPC201 • #2 15 lbs. max picture weight	1500 ft.
WPC301 • #3 20 lbs. max picture weight	1125 ft.
WPC401 • #4 25 lbs. max picture weight	850 ft.
WPC501 • #5 43 lbs. max picture weight	500 ft.
WPC601 • #6 60 lbs. max picture weight	275 ft.
WPC801 • #8 100 lbs. max picture weight	125 ft.

Each	3 Spools	6 or more
\$20.52	\$18.26 each	\$17.14 each

> Sizes can be mixed for price break



Super SoftStrand® Plastic Coated Stainless Steel Wire

Super Soft Strand, is plastic-coated stranded stainless steel wire for picture framing. The clear kink resistant coating has a very soft feel that is smooth on your fingers and easy to twist. You can wrap it tight and secure knots without puncturing your fingers or wrestling the stiff sharp ends like uncoated braided or other plastic coated wires.

Available in individual spools, this is the preferred picture framing wire throughout the industry and it's made in USA.

Available in 6 gauges:	Approx. Ft. Per Spool
WPS201 • #2 15 lbs. max picture weight	1500 ft.
WPS301 • #3 20 lbs. max picture weight	1125 ft.
WPS401 • #4 25 lbs. max picture weight	850 ft.
WPS501 • #5 43 lbs. max picture weight	500 ft.
WPS601 • #6 60 lbs. max picture weight	275 ft.
WPS801 • #8 100 lbs. max picture weight	125 ft.

Each	3 Spools	6 or more
\$25.14	\$22.63 each	\$20.87 each

> Sizes can be mixed for price break



• Pictured with wire (not included)

Picture Wire Caddy

Tabletop wire caddy holds 5lb. spools of braided picture wire for easy dispensing and control of spools on your work table. Holds all wire gauges and has center slot to feed wire without it riding off of the spool. Complete with handle for portability.

Item #	Description	Each
WC1000	Wire Caddy	\$13.85



SoftStrand® Stainless Steel Wire

The original "finger-friendly" picture wire, this high-strength, corrosion resistant stainless steel is soft, flexible, and fray resistant. Stainless steel finish will not mar walls or hands and will retain its strength and will not corrode or discolor.

Available in 7 gauges:	Approx. Ft. Per Spool
870-1 • #1 12 lbs. max picture weight	1650 ft.
870-2 • #2 20 lbs. max picture weight	1125 ft.
870-3 • #3 30 lbs. max picture weight	825 ft.
870-4 • #4 35 lbs. max picture weight	625 ft.
870-5 • #5 40 lbs. max picture weight	550 ft.
870-6 • #6 50 lbs. max picture weight	465 ft.
870-8 • #8 60 lbs. max picture weight	375 ft.

Each	3 Spools	6 or more
\$28.22	\$25.42 each	\$23.88 each

> Sizes can be mixed for price break



Using the Surflon® System

Surflon® wire is smooth, nylon-coated stainless steel wire that is secured with crimping sleeves and a crimping plier. The Surflon System saves you time by eliminating the need to tie or wrap, and it creates a custom, professional appearance.

To achieve the professional look and dependable strength of the Surflon System, just follow these few simple steps:

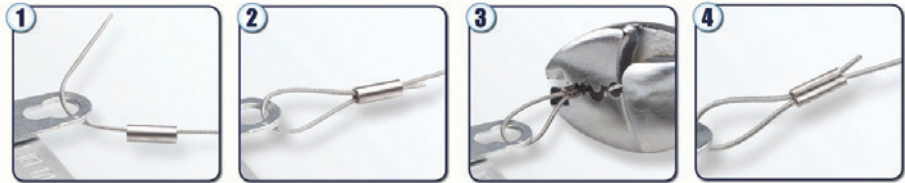

Note: Factors such as hardware and wall construction may affect the maximum picture weight to be used. Therefore, to achieve the safest and strongest hold, do not exceed the recommended maximum picture weight for each size of Surflon wire.

Surflon Wire System

The Surflon® Starter Kit is a great way to try the Surflon system! Each kit contains detailed instructions, a 300 ft. (92 m) spool of Surflon wire, 200 crimping sleeves, and a pair of Deluxe Crimping & Cutting Pliers. This is enough material to wire approximately one-hundred 24" x 36" (61 cm x 91 cm) frames. The kits are economically priced so you can try the system without having to purchase larger spools and packages of sleeves. Give it a try...once you use Surflon, you'll never wrap wire again!

#2 Wire System Kit

• 30 lb. maximum hanging weight

Item #	Color	Price Per Kit
6794	Bright	\$71.00
6795	Black	\$71.00

#3 Wire System Kit

• 40 lb. maximum hanging weight

Item #	Color	Price Per Kit
6796	Bright	\$72.26
6797	Black	\$72.26

#4 Wire System Kit

• 60 lb. maximum hanging weight

Item #	Color	Price Per Kit
6798	Bright	\$79.58
6799	Black	\$79.58



Surflon Coated Stainless Steel Wire

This nylon coated stainless steel wire is designed to be used with Surflon crimping sleeves as part of the Surflon wiring system. Available in Bright (silver), Black, and Bronze. 1000 feet per spool.

Item #	Color	#	Wt.	Each	3 Spools	6+
6801	Bright	2	30	\$59.18	\$56.83	\$54.45
6802	Bright	3	40	\$63.76	\$61.23	\$58.67
6803	Bright	4	60	\$73.84	\$70.88	\$67.92
6804	Bright	7	105	\$95.73	\$91.91	\$88.06
7801	Black	2	30	\$59.18	\$56.83	\$54.45
7802	Black	3	40	\$63.76	\$61.23	\$58.67
7803	Black	4	60	\$73.84	\$70.88	\$67.92
7804	Black	7	105	\$95.73	\$91.91	\$88.06
9211W	Bronze	6	45	\$63.29	\$60.76	\$58.22
9212W	Bronze	7	68	\$78.77	\$75.62	\$72.47



Surflon Crimping Sleeves

Surflon sleeves are made of copper and are designed to be used with Surflon wire and crimping tools. Match Surflon sleeve sizes to corresponding Surflon wire sizes for tight, secure connections that are virtually impossible to come apart.

• Designed to be used with Surflon wire only; not guaranteed to work with other wires.

Item #	Color	Size	Price Per Pack
6811	Bright	#2	\$47.53
6812	Bright	#4	\$66.65
6813	Bright	#7	\$98.34
7811	Black	#2	\$47.53
7812	Black	#4	\$66.65
7813	Black	#7	\$98.34
9213W	Bronze	#6	\$96.18
9214W	Bronze	#7	\$98.34



Surflon Crimping Pliers

This tool has three crimping dies designed for crimping all sizes of Surflon sleeves. Added cutting tip added to snip wire.

Item #	Description	Each
9210W	Surflon Crimper	\$32.48





C+H No. 1200™ Mat Cutter Blades

Fits C+H & Fletcher Mat Cutters. High quality steel blades for general mat cutting use. Available in double edge for regular cutting and single edge fine cutting. 100 Blades per box. •.012 gauge

Item #	Description	Each Box
9229	#1200SE: Single Edged	\$22.08
9230	#1200: Double Edged	\$19.85



C+H No. 1500™ Mat Cutter Blades

Fits C+H & Fletcher Mat Cutters. High quality steel blades for rag mats & heavy duty cutting. Available in double edge for regular cutting and single edge for fine cutting. 100 Blades per box. •.015 gauge

Item #	Description	Each Box
9228	#1500SE: Single Edged	\$22.08
9231	#1500: Double Edged	\$19.85



Logan™ Mat Cutter Blades

Pack of 100 Logan Style 270 Mat Cutter Blades for use with Logan Mat Cutter numbers 301, 301S, 401, 700S, 700SGM, 701, 760SGM, 1000, 2000, 3000, and 4000. 1 1/2" x .012 gauge blades.

Item #	Description	Each Box
BL1004	100 1.5" x .012 blades	\$13.00



Omega Mat Cutter Blades

Fits C+H & Fletcher Mat Cutters. High quality steel blades: .012 gauge for regular mat cutting, and .015 gauge blades for rag mats & heavy duty mat cutting. Both gauges are available in double edge for general cutting and single edge for fine cutting of rag mat, 8ply and specialty mats. 100 Blades per box. 

Item #	Description	Each Box	
BL1000	.012 Single Edged Blades	\$10.59	• Single Edged (SE)
BL1001	.012 Double Edged Blades	\$10.59	
BL1002	.015 Single Edged Blades	\$10.59	• Double Edged
BL1003	.015 Double Edged Blades	\$10.59	



Razor Blades

High quality stainless steel single edged razor blades for a great number of general use cutting needs around the frame shop. Available with notched edges or without to fit into certain tools and blade holders. 100 razors per box. 

Item #	Description	Each Box
BL1007	#9 Blade, Notched • 100 blades	\$6.24
BL1008	#12 Blade, Notched • 100 blades	\$6.47
BL1009	#12 Blade, No Notch • 100 blades	\$6.81



• Use with straight edges see page 70.

Dexter Mat Cutter

Cuts a straight or bevel edge with absolute accuracy. Push along T-square or straight edge to guide your cut. Great frameshop staple; use for oversize cuts that exceed your machine. Knob adjusts blade to any angle or depth. Chrome plated. Complete with five No. 3 blades.

Item # DEXMATCT \$23.73 each

Dexter Style Mat Cutter Blades

Available in packs of 5 or 100, these stainless steel blades are made to fit the Dexter line of hand held manual mat cutting tools and the Professional Trimming Tool (H135) used for cutting backing papers. 

Item #	Description	Each Pack
BL1010	5 ct. 1.5" x .012 blades	\$ 1.35
BL1011	100 ct. 1.5" x .012 blades	\$18.55



• Expertly crafted in England from Sheffield Steel!

Keencut™ Medium Duty Blades

For Keencut machines, these medium duty blades made in England from world-renowned Sheffield Steel, provide a longer life and superior edge for performance cutting up to 3/8" thick. Fits Keencut cutters Excalibur 1000x & 5000, Ultimat Futura, Flexo Futura, Ultimat Gold, SteelTrak, Sabre series, Javelin series, Evolution series, Max, Simplex, and Artist series cutters. 100 blades/pack

Item #	Description	Each Pack	
MDBLADES	100 Blade Pack	\$25.80	

Keencut™ Heavy Duty Blades

For Keencut machines, these heavy duty blades are made in England from world-renowned Sheffield Steel, provide a longer life and superior edge for performance cutting up to 1/2" thick materials on vertical cutters. Fits Keencut cutters Excalibur 1000x & 5000, Ultimat Futura, Flexo Futura, Ultimat Gold, SteelTrak, Sabre series, Javelin series, Evolution series, Max, Simplex, and Artist series cutters. 100 blades/pack

Item #	Description	Each Pack	
HDBLADES	100 Blade Pack	\$41.27	



Hassle-Free Trimming Tool

Used for trimming paper dustcovers and backing tape on the reverse of frames. The blade is set 3mm in from the edge to allow a neat, clean finish. Ergonomic handle makes cutting a breeze and can be used right or left handed. 

Item #	Description	Each
HFTRIMTL	Hassle-Free Trimmer	\$ 9.36



Professional Trimming Tool

Exposed blade fits into a molded tract that allows for maximum finger protection & superior eyesight lines for the cleanest, most convenient trimming of backing paper. Uses Dexter style blades for blade replacement. Tool comes with 5 blades. 

Item #	Description	Each
H135	Trim Tool w/5 blades	\$ 3.43



Retractable Utility Knife

Solid cast metal retractable utility knife made to last and made in the USA. Uses utility blades **BL1005** (General Duty, .017 thick) and **BL1006** (Heavy Duty, .025 thick). Handle has receptacle for extra blade storage (comes with 3 blades).

Item #	Description	Each
BL1012	Utility Knife w/3 blades	\$ 4.57



Snap & Retract Utility Knife

Lightweight & handy utility knife that uses a single strip, 8-point snap-off blade. Conveniently renew each blade point simply by snapping off used section with pliers to expose new edge. Retract blade for safety. Comes with 1 8-point blade.

Item #	Description	Each
BL1013	Snap Knife w/1 strip	\$ 3.02

Utility Blades

General Duty (.017 thick) and Heavy Duty (.025 thick) utility blades for use in retractable knife and other cutting tools. 100 blades per pack

Item #	Description	Each Pack
BL1005	100 General Duty Blades	\$13.46
BL1006	100 Heavy Duty Blades	\$16.46



Snap Blades

Quality carbon steel 8-point blades for use in Snap & Retract Utility Knife (BL1013). 10 8-point blades per pack

Item #	Description	Each Pack
BL1014	10 8-point Snap Blades	\$ 3.83
7010MR	100 8-point Snap Blades	\$32.33

X-ACTO® Gripster

X-Acto's Gripster Knife features a soft rubberized barrel for a firmer, more comfortable grip and better control. Rear blade release makes blade changing safer, easier, and faster. One blade is included.

Item #	Description	Each
BFX3627	XACTO Gripster Knife	\$4.58
BL1211	XACTO #11 Blades (5 pack)	\$2.39



Xacto
#11 Blades
BFX211



Hobby Knife #1

Hobby Knife #1 has a 4 3/4" long aluminum handle with threaded blade vise, and comes with a standard #11 blade, (BL1015 & BL1016) and safety cap.

Item #	Description	Each
BL1017	Hobby Knife #1	\$2.74



Hobby Knife Blades

#11 Blades for Hobby Knife #1 & XACTO Gripster (BFX3627). Available in packs of 5 & 100.

Item #	Description	Each Pack
BL1015	5 #11 Blades	\$ 1.82
BL1016	100 #11 Blades	\$26.25



XACTO® #8 Board Cutter Blades

5 dual-sided replacement blades for the XACTO Board Cutter (BFX7747).

Item #	Description	Each Pack
BFX208	5 # 8 Blades	\$ 2.86



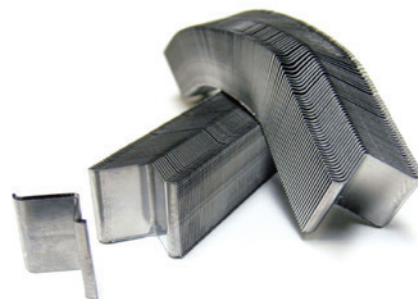

Omega Corner Nails

Manufactured for reliability and ease of use, Omega Corner Nails are crafted with a single sharpened edge on high quality steel to ensure smooth fluid penetration into wood or plastic mouldings. Designed for hard wood, soft wood, medium-density fiberboard (MDF), and polystyrene mouldings, and for use with Pistorius, Putnam/AMP, and Cassese pneumatic underpinners.

Corner Nails for Pistorius Underpinners

Item #	Size	Wood Type	QTY/Box	Each	5 Boxes	10 Boxes
VN2000	1/4"-7mm	Soft Wood	6000	\$18.50	\$17.57	\$15.73
VN2001	1/4"-7mm	Hard Wood	6000	\$18.50	\$17.57	\$15.73
VN2002	3/8"-10mm	Soft Wood	6000	\$21.72	\$20.64	\$18.47
VN2003	3/8"-10mm	Hard Wood	6000	\$21.72	\$20.64	\$18.47
VN2004	1/2"-12mm	Soft Wood	6000	\$27.51	\$26.13	\$23.38
VN2005	1/2"-12mm	Hard Wood	6000	\$27.51	\$26.13	\$23.38
VN2006	5/8"-15mm	Soft Wood	6000	\$30.94	\$29.40	\$26.30
VN2007	5/8"-15mm	Hard Wood	6000	\$30.94	\$29.40	\$26.30

Corner Nails for Putnam/AMP Underpinners

Item #	Size	Wood Type	QTY/Box	Each	5 Boxes	10 Boxes
VN3000	1/4"-7mm	Soft Wood	6000	\$19.59	\$18.61	\$16.65
VN3001	3/8"-10mm	Soft Wood	6000	\$22.82	\$21.67	\$19.39
VN3002	1/2"-12mm	Soft Wood	6000	\$28.60	\$27.17	\$24.31
VN3003	5/8"-15mm	Soft Wood	6000	\$32.04	\$30.43	\$27.24
VN3004	1/4"-7mm	Hard Wood	6000	\$19.59	\$18.61	\$16.65
VN3005	3/8"-10mm	Hard Wood	6000	\$22.82	\$21.67	\$19.39
VN3006	1/2"-12mm	Hard Wood	6000	\$28.60	\$27.17	\$24.31
VN3007	5/8"-15mm	Hard Wood	6000	\$32.04	\$30.43	\$27.24

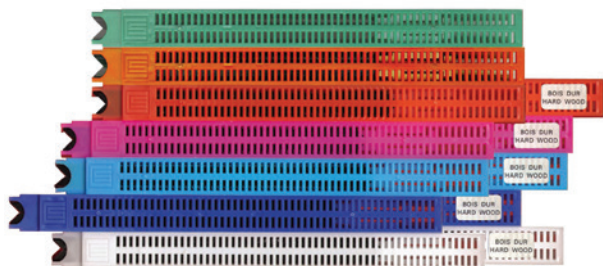

Corner Nails for Cassese Underpinners

Item #	Size	Wood Type	QTY/Box	Each	5 Boxes	10 Boxes
VN4000	1/4"-7mm	Soft Wood	1650	\$10.16	\$ 9.65	\$ 8.64
VN4001	1/4"-7mm	Hard Wood	1650	\$10.16	\$ 9.65	\$ 8.64
VN4002	3/8"-10mm	Soft Wood	1650	\$12.18	\$11.56	\$10.35
VN4003	3/8"-10mm	Hard Wood	1650	\$12.18	\$11.56	\$10.35
VN4004	1/2"-12mm	Soft Wood	1650	\$14.02	\$13.32	\$11.92
VN4005	1/2"-12mm	Hard Wood	1650	\$14.02	\$13.32	\$11.92
VN4006	5/8"-15mm	Soft Wood	1650	\$14.18	\$13.46	\$12.04
VN4007	5/8"-15mm	Hard Wood	1650	\$14.18	\$13.46	\$12.04



Inmes Universal V-Pins

Inmes Universal V-pins fit INMES, Charmwood, Morso, Delta, Euro, & Fletcher models 5000 & 5100

Item #	Size	Wood Type	QTY/Box	Each
3749S	3/16"-5mm	Soft Wood	6000	\$30.19
3750H	1/4"-7mm	Hard Wood	4000	\$13.13
3750S	1/4"-7mm	Soft Wood	4000	\$13.13
3751H	3/8"-10mm	Hard Wood	3000	\$12.32
3751S	3/8"-10mm	Soft Wood	3000	\$12.32
3752H	1/2"-12mm	Hard Wood	2000	\$10.17
3752S	1/2"-12mm	Soft Wood	2000	\$10.17
3753H	5/8"-15mm	Hard Wood	2000	\$11.38
3753S	5/8"-15mm	Soft Wood	2000	\$11.38

Inmes V-Pins for Pistorius

Item #	Size	Wood Type	QTY/Box	Each
105029S	3/16"-5mm	Soft Wood	6000	\$32.12
3740H	1/4"-7mm	Hard Wood	4000	\$25.69
3740S	1/4"-7mm	Soft Wood	4000	\$25.69
3741H	3/8"-10mm	Hard Wood	3000	\$24.35
3741S	3/8"-10mm	Soft Wood	3000	\$24.35
3742H	1/2"-12mm	Hard Wood	2000	\$20.27
3742S	1/2"-12mm	Soft Wood	2000	\$20.27
3743H	5/8"-15mm	Hard Wood	2000	\$22.60
3743S	5/8"-15mm	Soft Wood	2000	\$22.60

Inmes V-Pins for Putnam/AMP

Item #	Size	Wood Type	QTY/Box	Each
1050091	3/16"-5mm	Soft Wood	6000	\$32.12
1050092	1/4"-7mm	Soft Wood	4000	\$25.69
1050093	3/8"-10mm	Soft Wood	3000	\$24.35
1050094	1/2"-12mm	Soft Wood	2000	\$20.27
1050095	5/8"-15mm	Soft Wood	2000	\$22.60
1050096	1/4"-7mm	Hard Wood	4000	\$25.69
1050097	3/8"-10mm	Hard Wood	3000	\$24.35
1050098	1/2"-12mm	Hard Wood	2000	\$20.27
1050099	5/8"-15mm	Hard Wood	2000	\$22.60

Inmes V-Pin Cartridges for Cassese

* 8 Cartridges per box, 2200 V-pins total per box

Item #	Size	Wood Type	QTY/Box	Each
1050348	1/4"-7mm	Hard Wood	2200	\$26.27
1050349	3/8"-10mm	Hard Wood	2200	\$29.20
1050350	1/2"-12mm	Hard Wood	2200	\$32.40
1050351	5/8"-15mm	Hard Wood	2200	\$35.04
1050352	3/16"-5mm	Soft Wood	2200	\$24.35
1050353	1/4"-7mm	Soft Wood	2200	\$26.27
1050354	3/8"-10mm	Soft Wood	2200	\$29.20
1050355	1/2"-12mm	Soft Wood	2200	\$32.40
1050356	5/8"-15mm	Soft Wood	2200	\$35.04



Items with this symbol "Ride Along" with your length or chop moulding order at no extra delivery charge.

California Customers
WARNING: Cancer and Reproductive Harm
www.P65Warnings.ca.gov



Thumbnail Frame Joining Inserts

Thumbnail inserts are the strongest, most durable inserts for a variety of moulding sizes. All three insert sizes are tapered to draw the face of the moulding together when joined with glue. 

Item #	Description	Each
5051	3/8" - Qty. 500 inserts	\$37.43
5052	5/8" - Qty. 500 inserts	\$42.93
5053	15/16" - Qty. 250 inserts	\$25.50



Router Bits for C+H Thumbnailer

Steel and carbide replacement bits for the C+H Thumbnailer Master router. 

Item #	Description	Each
5054	Steel Replacement Bit	\$25.35
5054C	Carbide Replacement Bit	\$44.05

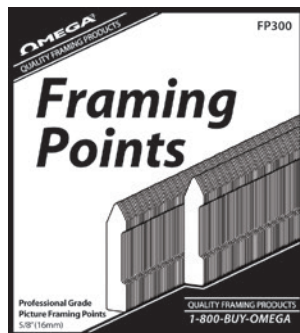

Omega Framing Points

Omega Framing Points are designed to fit the Fletcher FrameMaster manual hard point driver. Box contains 3,000 5/8" (16mm) points per box. (100 points per stack).

Item #	Description	Each	5 Boxes+
FP300	3000 Hard Points/Box	\$ 9.90	\$ 9.22 each

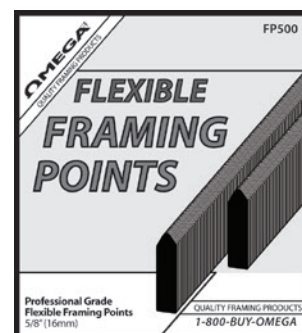

Omega Flexible Framing Points

Omega Flexible Framing Points are designed to fit the Fletcher FlexMaster as well as manual flex point driver #FPDRIVER. Box contains 3,000 5/8" (16mm) points per box. (250 points per stack).

Item #	Description	Each	5 Boxes+
FP500	5000 Flex Points/Box	\$11.68	\$10.68 each



Omega Framing Points for Pneumatic Point Drivers

Long sleeve Omega Framing Points are designed to fit FrameMaster & compatible pneumatic hard point drivers. Box contains 12,000 5/8" long points per box.

Item #	Description	Each
FP1200	12000 Hard Points/Box	\$31.44



Universal Hardpoints

Universal Framing Points are designed to fit manual hard point driver (Item# HPDRIVER). 3,000 5/8" (16mm) points/box or 5000 3/8" (10mm) points/box.

Item #	Description	Each	5+ boxes	Item #	Description	Each
FP85	3000 Hard Points/Box	\$18.12	\$15.53 each	1050086	5000 Hard Points/Box	\$40.88

Inmes Stainless Steel Flexpoints

Flexible points are designed to fit manual flexible point driver (Item# FPDRIVER). 5,000 1/2" (14mm) points/box

Item #	Description	Each
1050083	5000 Flex Points/Box	\$30.25



OMER Hardpoints

OMER Framing Points are designed to fit OMER pneumatic hard point driver (Item# 9285). Box contains 10,000 15mm points each.

Item #	Description	Each	3+ boxes
9286	10000 OMER Hard Points/Box	\$58.45	\$50.15 each



Flexible Framing Points for OMER Pneumatic Point Drivers

Flexible Framing Points are designed to fit OMER type pneumatic flexible point drivers. Box contains 5,000 5/8" (15mm) long points per box (Item FP77), or in 15,000 qty. box (Item 9287). 

Item #	Description	Each
FP77	Inmes Flexible Points 5000/Box	\$16.26
9287	OMER Flexible Points 15000/Box	\$64.18





Framer's Hard Point Driver

This well engineered manual rigid-point driver features an all metal die-cast body with a comfort grip trigger handle that's built to last. Loads quickly and easily in front channel and firing pressure can be adjusted for different wood densities. Uses Inmes 16mm rigid framing points (Item FP85). 

Item #	Description	Each
HPDRIVER	Hard Point Driver	\$50.78

Item #	Compatible Points	Each	5+ boxes
FP85	3000 Hard Points/Box	\$18.12	\$15.53 each



Framer's Flexible Point Driver

Built strong with the same all metal die-cast body as our Hard-Point Driver (above), this point driver fires 15mm standard flexible framing points. Easily load points in front channel and adjust firing pressure with back knob for different woods to control driving depth of flexpoint. Uses Fletcher-type flexible framing points (Item# FP500). 

Item #	Description	Each
FPDRIVER	Flexible Point Driver	\$50.78

Item #	Compatible Points	Each	5 Boxes+
FP500	5000 Flex Points/Box	\$11.68	\$10.68 each
FP77	5000 Flex Points/Box	\$16.26	



Framer's Pneumatic Point Drivers

These pneumatic point drivers feature a lightweight die-cast aluminium body, at a total weight of under 2 lbs. with a rubberized ergonomic comfort grip and safety catch on the operating trigger. Easy-to-operate in left-to-right or right-to-left single motion with no "pullback" required. Operates at 4.5bar/90psi. 

Item #	Description	Each
PNRIGDR	Pneumatic Hard Point Driver (Red)	\$183.75
PNFLXDR	Pneumatic Flex Point Driver (Yellow)	\$183.75

Item #	Compatible Hard Points (Red)	Each
FP1200	12000 Hard Points/Box	\$31.44
9286	10000 OMER Hard Points/Box	\$58.45

Item #	Compatible Flexible Points (Yellow)	Each
FP77	Inmes Flexible Points 5000/Box	\$ 16.26
9287	OMER Flexible Points 15000/Box	\$ 64.18



OMER Pneumatic Flexible Point Driver

OMER air flexipoint drivers fire 15mm flexible and rigid framing points. Lightweight and strongly constructed for reliability and years of use, OMER drivers are designed for volume production. Air drives with little noise, no recoil, and fast air recycle. Uses flexible points Item# FP77 and #9287. 

Item #	Description	Each
9285	OMER Pneumatic Flexible Point Driver	\$424.38

Item #	Compatible Points	Each
FP77	Flexible Points 5000/Box	\$ 16.26
9287	OMER Flexible Points 15000/Box	\$ 64.18



Senco Pneumatic Brad Nailer

The Senco SLP20XP drives a wide range of both slight-headed and medium headed brads to give you two tools in one. Weighs only 2.3 lbs. - the lightest weight available in a brad nailer - for easy maneuvering and handling in small places. Features easy side loading that allows you to choose brad length without adjusting tool, plus an E-Z Clear jam feature allowing easy removal of a jammed fastener. Superior power (40% more than comparable tools) makes this 18 gauge brad nailer ideal for moulding and trim. Oil free design means easier maintenance and no lubrication to stain fine woods. *Not recommended for fitting. Uses 1/4" male air nipple, not included.* 

Item #	Description	Each
100S	Senco Pneumatic Brad Nailer	\$217.75



Senco Pneumatic Long Nose Staplers

Compact and durable, the SFT10XP delivers best-in-class performance for a variety of fine wire stapling applications. Models drive staples ranging in length from 5/32-in to 5/8-in. Heavy-duty steel cap offers superior balance with minimal recoil and a one-handed magazine opening for increased productivity. Rear exhaust directs oil and dust away from the work surface. Short trigger stroke provides quick and precise operation. Long lip length makes getting into tight spots easier. Adjustable firing rate from single shot to 30 fasteners per second. 

Item #	Description	Each
120	Senco (SFT10XP-C) C-Type Stapler Uses #114, #118, #119 C-type Staples	\$274.92

110	Senco (SFW10XP-G) G-Type Stapler Uses #115, #116, #117 G-type Staples	\$279.90
------------	--	----------



Fasco Long-Nose C-Type Stapler

The Fasco F1B 7C-16 LN-50 long nose stapler delivers European reliability, power and refinement. Drives 3/8" crown width Senco C, BeA 71 and Empire 7 series staples. 2" nose length allows stapling in deep recesses and hard-to-reach places. Bottom load design provides ease and speed when reloading, changing sizes or clearing a jam. Staples range all the way from 1/4" to 5/8" leg lengths. Magazine opens with easy, one finger latch. Reversible bumper for added parts life. A comfortable, fast, and durable stapler great for production fitting and gallery wrap applications. Uses Item #5061 staples. Uses 1/4" male air nipple, not included. 

Item #	Description	Each
5060	Pneumatic C-Type Stapler	\$268.41

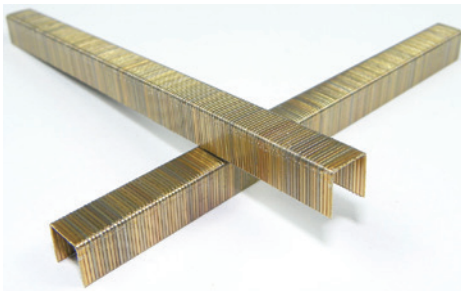

Fasco C-Type Staples

3/8" Crown 22-gauge wire staples for Fasco/Mastri/Senco pneumatic staplers. 10,000 per box. 

Item #	Description	Each	5-9@	10+ @
5061	3/8" C-Type Staples	\$12.00	\$11.40	\$10.80



Senco C-Type Staples

3/8" crown 22-gauge wire staples for Fasco/Mastri/Senco pneumatic staplers. 

Item #	Description	Each
119	5/16" long C-Type Staples • 28,000/box	\$32.38
118	1/2" long C-Type Staples • 35,000/box	\$36.59
114	3/16" long C-Type Staples • 55,000/box	\$54.86



Senco G-Type Staples

3/8" crown 20-gauge wire staples for Fasco/Mastri/Senco pneumatic staplers. 5,000 staples per box. 

Item #	Description	Each
115	3/8" long G-Type Staples • 5,000/box	\$24.20
116	1/2" long G-Type Staples • 5,000/box	\$26.88
117	5/8" long G-Type Staples • 5,000/box	\$29.51



Senco Brad Nails

• 5000 Galvanized nails per box

Item #	Description	Each
104	3/4" Senco AY11 Brads (small head)	\$26.84
105	5/8" Senco AY10 Brads (small head)	\$25.75
106	1" Senco AX13 Brads (medium head)	\$14.92
107	1 1/4" Senco AX15 Brads (medium head)	\$16.98
108	1" Senco AY13 Brads (small head)	\$29.56



Framer's Vise

Holds miters in perfect alignment for non-slip fastening. Securely clamps moulding up to 4" wide at 90° for joining and nailing. Table mount base.

Item #	Description	Each
FRVISE4	Framer's Miter Vise	\$54.56

Master Clamp

Master Clamp joins frames under high pressure only using glue. Patented design clamp evenly distributes glue evenly along joined surfaces with 1000 lbs. of pressure per square inch and reduces drying time to approximately 20 minutes creating a bond that is stronger than any other tool on the market. The oversized front clamping fence is fixed at a perfect 45 degrees and its fine closing adjustment feature and spring-loaded back fence adjustment.

- Eliminates the need for wax fillers/putty
- Comes ready to use right out of the box
- Comes complete with 2 moulding levelers

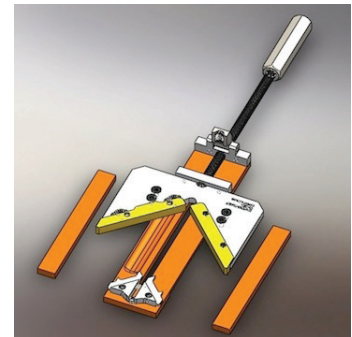

Master Clamp L

For large mouldings up to 3 1/2" wide.

Item # 5105	\$512.16
-------------	----------

Master Clamp XL

For extra-large mouldings up to 6 1/2" wide.

Item # 5106	\$595.09
-------------	----------

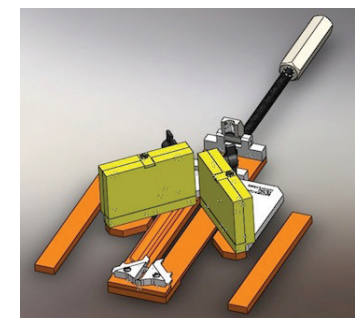

Master Clamp Shadow Boxer

For large shadow box depth mouldings.

Item # 5107	\$663.88
-------------	----------



See Page 61 for our complete line of Silent Air Compressors



TAKIYA exclusively from **OMEGA**



• Safety Mini Hanger Set

A: Hanger & 6' Cable w/ ring for CA hook & CB hook.

B: Hanger & 6' Cable for One-Touch hook.

• Safety N Hanger Set

A: Hanger & 6' Cable w/ ring for CA hook & CB hook.

B: Hanger & 6' Cable for One-Touch hook.

Item #	Set / Description	Gauge	Weight	Each	\$250 Assorted
TAK1008	Safety Mini Hanger A	1.2mm	35 lb.	\$26.94	\$24.78
TAK1009	Safety Mini Hanger B	1.2mm	35 lb.	\$23.51	\$21.62
TAK1010	Safety N Hanger A	1.5mm	65 lb.	\$58.47	\$53.80
TAK1011	Safety N Hanger A	2.5mm	150 lb.	\$65.35	\$60.13
TAK1012	Safety N Hanger B	1.5mm	65 lb.	\$44.72	\$41.15
TAK1013	Safety N Hanger B	2.5mm	150 lb.	\$51.60	\$47.47

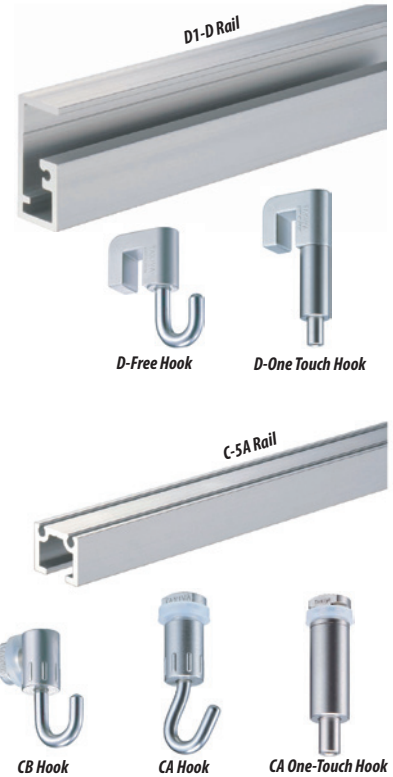

Item #	Description	Each	\$250 Assorted
TAK1000	C-5A Rail • 3 ft. section	\$11.36	\$10.44
TAK1001	CB Hook • 65 lb. capacity	\$ 9.18	\$ 8.43
TAK1002	CA Hook • 65 lb. capacity	\$ 9.18	\$ 8.43
TAK1003	1-Touch Hook • 65 lb. capacity	\$22.93	\$21.11

Item #	Description	Each	\$250 Assorted
TAK1004	D-1D Rail • 3 ft. section	\$22.93	\$21.11
TAK1005	D-Free Hook • 150 lb. capacity	\$22.93	\$21.11
TAK1006	Mini D-Free Hook • 35 lb. capacity	\$11.47	\$10.55
TAK1007	D 1-Touch Hook • 150lb. capacity	\$26.38	\$24.27

MuSE by Takiya

Framing and Hanging and hardware from Japan for situations where nothing but the best will do.

This patented line of superior quality stainless steel and aluminum hanging hardware has been used in museums and fine art galleries around the world.

Takiya's thoughtfully engineered products elegantly combine brilliant design with excellent functionality and safety for the hanging and support of valuable works of art and collectibles.

The picture rails can be built in or added to existing walls or ceilings. The hanger sets can be ordered with different components to create custom hanging solutions for a variety of display settings.

Many of these products are especially useful in earthquake prone areas where art must be secured for safety concerns.

Takiya - supporting great art.

• \$250 Price break is for \$250 purchase of Takiya products

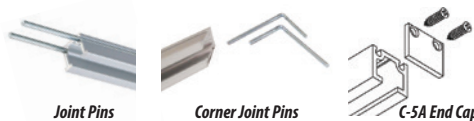

Item #	Description	Each	\$250 Assorted
TAK1018	Joint Pin • aligns rail joins (2 required)	\$0.28	\$0.26
TAK1019	Corner Joint Pin • aligns corner joins (2 required)	\$0.58	\$0.53
TAK1020	C-5A End Cap • for surface mounted rail application	\$3.44	\$3.16



Cable Wire

1.2 and 1.5 mm gauge steel wire nylon coated with a clear finish and in a variety of colors designed to blend with many wall colors and exhibit schemes.
• Sold in 6 foot lengths

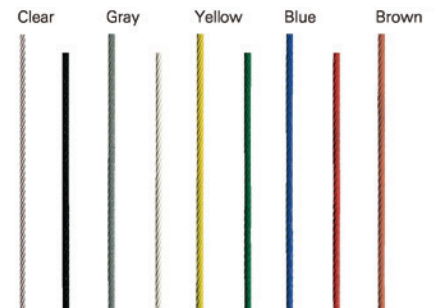

• Colored wire can be used to visually blend cables in with different wall colors.

Item #	Cable Gauge / Description	Each	\$250 Assorted
TAK1016	1.2mm clear coated + colors	\$14.91	\$13.71
TAK1017	1.5mm clear coated + colors	\$16.62	\$15.29

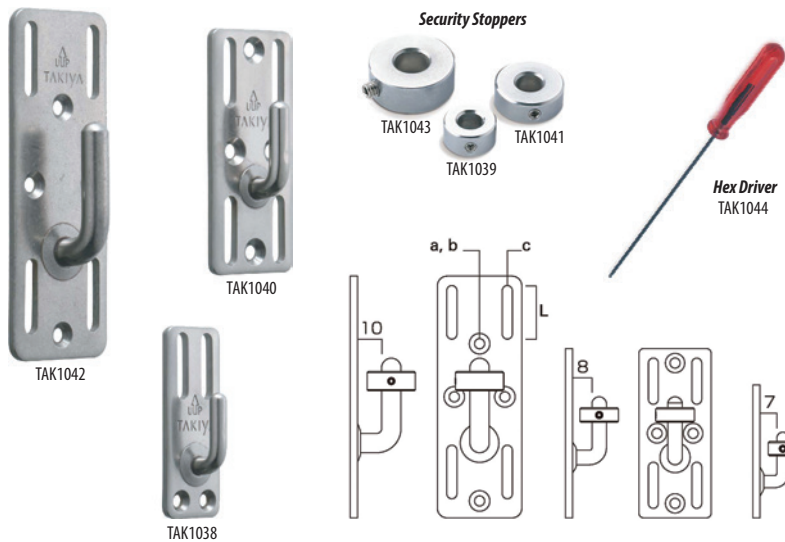

Wall Hooks & Security Stoppers

These special wall hooks are ideal for hanging display pieces with the added ability of securing the work from damage or theft. Security stoppers can be fastened to the tip of the wall hook to secure the d-ring from being removed from the hanger. Stoppers can be added and removed by adjusting the inset hex screw with the available specially designed hex driver tool.
Stainless Steel • wall screws not included

Item #	Description	Each	\$250 Assorted
TAK1038	110 lb. capacity wall hook	\$ 14.33	\$ 13.19
TAK1040	220 lb. capacity wall hook	\$ 17.20	\$ 15.82
TAK1042	330 lb. capacity wall hook	\$ 20.64	\$ 18.98

Item #	Description	Each	\$250 Assorted
TAK1039	Security Stopper (for 110 lb. hook)	\$ 5.05	\$ 4.64
TAK1041	Security Stopper (for 220 lb. hook)	\$ 6.31	\$ 5.80
TAK1043	Security Stopper (for 330 lb. hook)	\$ 7.56	\$ 6.96
TAK1044	Specialized 1.5mm Hex Driver	\$ 6.55	\$ 5.94

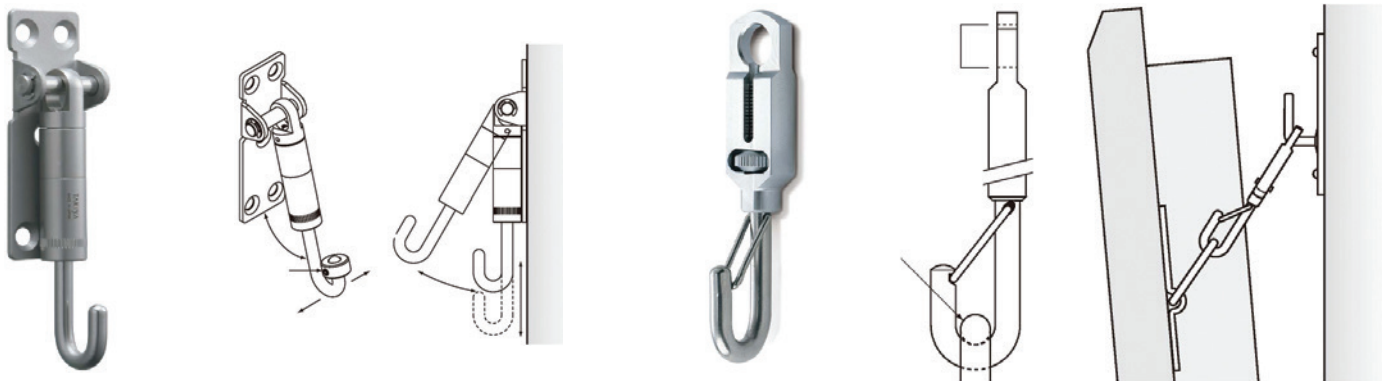

Multiple Function Wall Hook

This hanger has multiple functions such as securing items to prevent damage due to accidents, earthquakes, or theft. Additionally, it is vertically and laterally adjustable for positioning and repositioning artwork while securely hanging. Works with 110 lb. security stopper (TAK1039).
Stainless Steel • 110 lb. capacity • screws not included

Item #	Description	Each	\$250 Assorted
TAK1045	Multi-function wall hook • 110 lb. capacity	\$ 36.69	\$ 33.76

Adjustable Offset Hanger

This hanger is used to hang uniquely shaped or unconventionally framed work that may not have a flat back or has an offset strap hanger. Height can be adjusted by turning the threaded dial on the hanger so that you can level, raise or lower the piece after being hung. Strong catch securely contains D-ring.
Brass/Stainless Steel • 110 lb. capacity

Item #	Description	Each	\$250 Assorted
TAK1046	Adjustable offset hanger • 110 lb. capacity	\$ 18.34	\$ 16.88

Wall Mounted Support Brackets

These wall brackets are the best solution for supporting large size and heavyweight displays. Attach to wall by screwing into wall stud to support weight at the bottom of the piece.
Stainless Steel, shot blast finish • 220 lb. & 330 lb. capacity brackets

Item #	Description	Each	\$250 Assorted
TAK1047	Support Bracket • 220 lb. capacity	\$ 59.62	\$ 54.85
TAK1048	Support Bracket • 330 lb. capacity	\$ 68.80	\$ 63.29



Takiya - supporting great art.

TAKIYA

Premium Strap Hangers

These premium strap hangers are made with superior materials to traditional strap hangers and are engineered and tested for stress and durability. The rings were designed and developed for use with the hanging hooks for the MuSE cable hanging system and all Takiya hooks, also compatible with traditional wall hooks. *Stainless steel • screws not included*

Item #	Description	Capacity	Each	\$250 Assorted
TAK1021	Strap Hanger	330 lb.	\$17.20	\$15.82
TAK1022	Strap Hanger	220 lb.	\$14.91	\$13.71
TAK1023	Strap Hanger	110 lb.	\$11.47	\$10.55
TAK1024	Strap Hanger	65 lb.	\$ 2.29	\$ 2.11
TAK1025	Strap Hanger	22 lb.	\$ 2.06	\$ 1.91



► Hardware that conveys first-class workmanship for all of your high-end framing projects

Angled Hangers

These tastefully designed hangers have the rings set at the optimal angle to balance and reduce stress on the frame when hanging with wire. Hangers are sold in pairs (left and right side angled). *Stainless Steel*

Item #	Description	Capacity	Each	\$250 Assorted
TAK1026	Angled D-Rings (Pair)	100 lb.	\$ 9.28	\$ 8.55
TAK1027	Angled D-Rings (Pair)	65 lb.	\$ 6.88	\$ 6.33
TAK1028	Angled D-Rings (Pair)	35 lb.	\$ 4.13	\$ 3.79
TAK1029	Angled D-Rings (Pair)	22 lb.	\$ 3.78	\$ 3.49



Security Floret Wall Hooks

These beautiful stainless floret style wall hooks secure works by holding wire or D-ring on the hook by a metal clasp. Hooks can be fixed to wall by stainless steel pins or slim screws which minimize damage to the wall when removed. *Stainless Steel, Brass (pin head) • 15 lb. & 45 lb. capacity wall hooks*

Item #	Description	Capacity	Each	\$250 Assorted
TAK1049	1-Pin Security Floret	15 lbs.	\$ 3.78	\$ 3.49
TAK1050	3-Pin Security Floret	45 lbs.	\$ 6.88	\$ 6.33 (pins included)



Heavy Duty Pins



Slim Screws

Item #	Description	Each	\$250 Assorted
TAK1051	100 Pins / Box	\$91.73	\$84.39

Item #	Size / Box Qty.	Each	\$250 Assorted
TAK1052	16mm / 540 ct.	\$40.13	\$36.92
TAK1053	19mm / 480 ct.	\$40.13	\$36.92
TAK1054	24mm / 370 ct.	\$40.13	\$36.92
TAK1055	27mm / 310 ct.	\$40.13	\$36.92
TAK1056	32mm / 250 ct.	\$40.13	\$36.92
TAK1057	36mm / 230 ct.	\$40.13	\$36.92

TAKIYA

Striking framing and hanging hardware will convey painstaking attention to detail that collectors and connoisseurs demand.

All Takiya items are "Ride Along" eligible

▲ California Customers - WARNING: Cancer and Reproductive Harm - www.P65Warnings.ca.gov

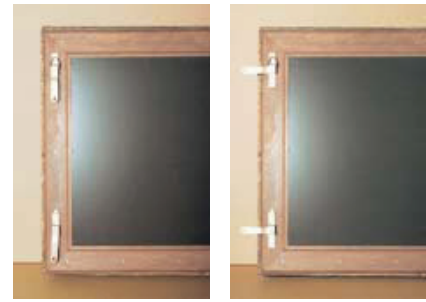
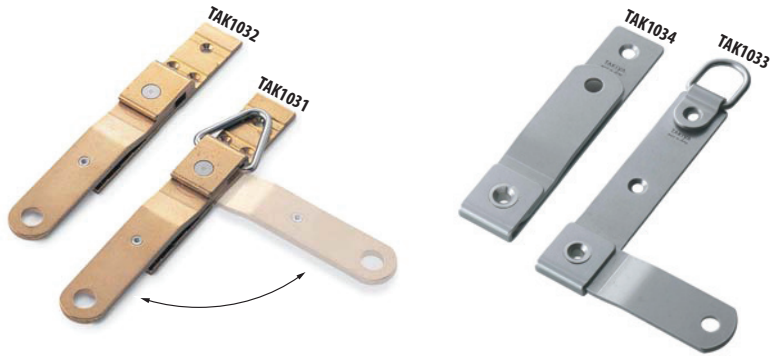

Folding Shipping Braces

Folding Shipping Braces are used to attach artwork inside wooden crates for transportation. Braces swivel out to allow for reinforcing the arm to crating (with screws or bolts) and swivel in for storage or to hang piece on the wall (for models with stationary D-rings). *Brass, Stainless Steel*

Item #	Description	Each	\$250
			Assorted
TAK1031	Brass Shipping Brace with stationary ring	\$ 28.67	\$ 26.38
TAK1032	Brass Shipping Brace	\$ 26.94	\$ 24.78
TAK1033	Steel Shipping Brace with stationary ring	\$ 12.61	\$ 11.60
TAK1034	Steel Shipping Brace	\$ 11.47	\$ 10.55

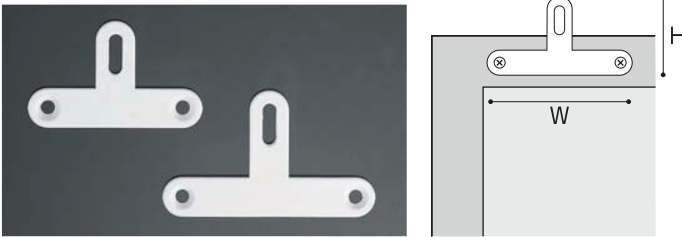

T-Clip Flush Hangers

These T-shaped clips attach to the back of the frame and enable you to set it closely to the wall surface with wood screws. White coated metal blends into white walls when hanging. Oblong screw slots allow for adjusting and leveling hanging height.

Item #	Description	Each	\$250
			Assorted
TAK1036	Small T-Clip • 1 3/4" x 1"	\$ 2.29	\$ 2.11
TAK1037	Large T-Clip • 2 1/8" x 1 1/4"	\$ 2.76	\$ 2.54

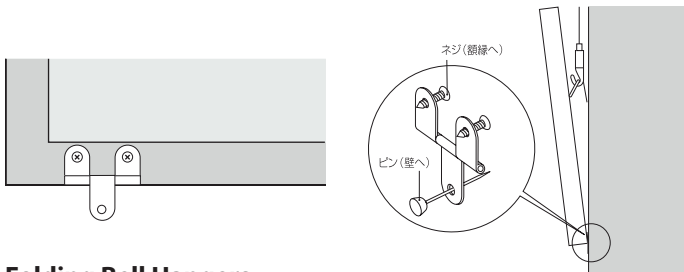

Frame Wire Clips

Wire clips help prevent framed pieces from falling forward when hung by wire and also hold wired pieces closer to the wall for a uniform look. Clips can be attached to the back of the frame or to the wall. *Stainless steel clip • screws included*

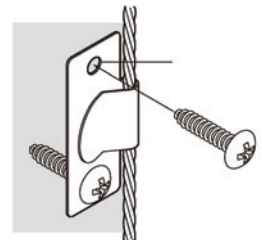

Folding Bell Hangers

These hangers are designed to protect hanging artwork in the event of an earthquake or wire breakage by securing the frame to the wall. Hardware attaches to frame at bottom edge on back and to the wall directly behind.

Chromed steel, with screws and pins included for each.

Item #	Description	Each	\$250
			Assorted
TAK1030	Anti-Swing Folding Bell Hanger	\$ 4.69	\$ 4.33

Item #	Description	Each	\$250
			Assorted
TAK1035	Frame Wire Clips • Box of 50	\$ 86.00	\$ 79.12

Picture hanging solutions that set the global standard.



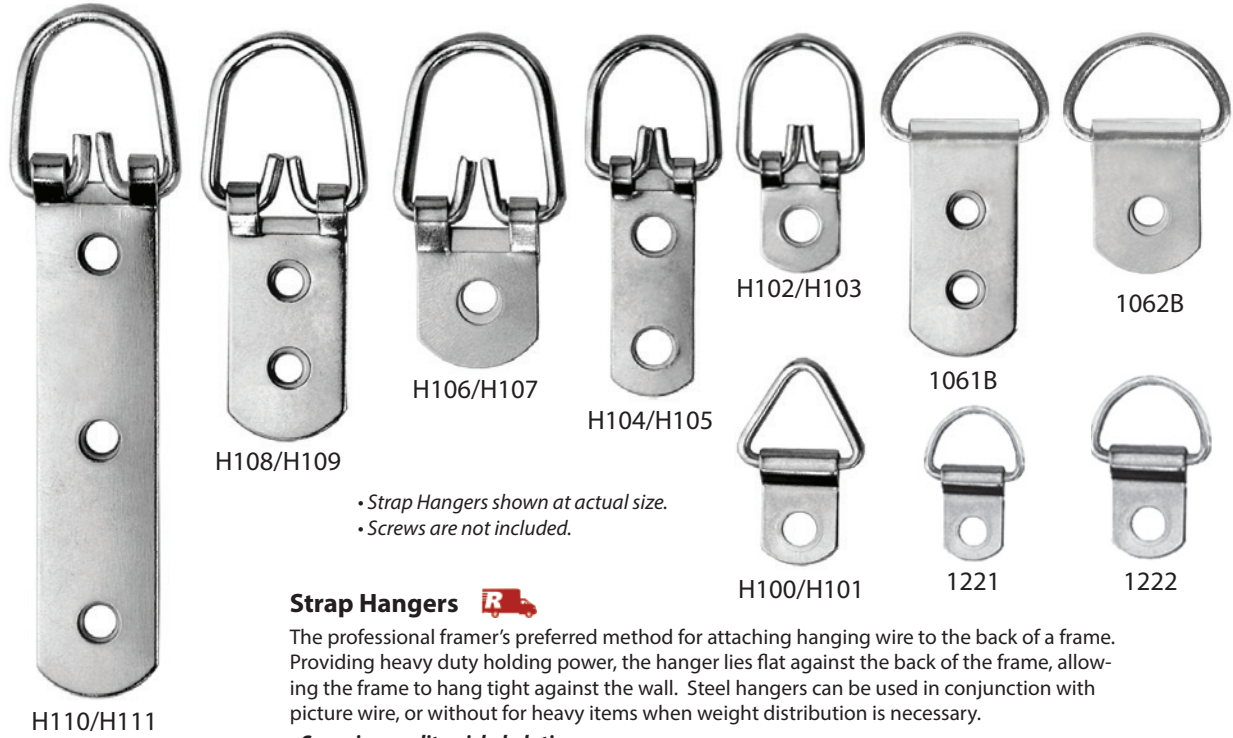

• Strap Hangers shown at actual size.
• Screws are not included.

Strap Hangers

The professional framer's preferred method for attaching hanging wire to the back of a frame. Providing heavy duty holding power, the hanger lies flat against the back of the frame, allowing the frame to hang tight against the wall. Steel hangers can be used in conjunction with picture wire, or without for heavy items when weight distribution is necessary.

• Superior quality nickel plating.

Item #	Size	Type	QTY/Box	Each
H100	1 1/8"	1 Hole	1000	\$20.87
H101	1 1/8"	1 Hole	200	\$ 4.25
H102	1 1/4"	1 Hole	1000	\$25.06
H103	1 1/4"	1 Hole	200	\$ 7.26
H104	1 7/8"	2 Hole	1000	\$33.05
H105	1 7/8"	2 Hole	200	\$ 8.68
H106	1 3/4"	1 Hole	1000	\$65.03
H107	1 3/4"	1 Hole	200	\$15.96

Item #	Size	Type	QTY/Box	Each
H108	2 1/8"	2 Hole	1000	\$ 71.64
H109	2 1/8"	2 Hole	200	\$ 18.17
H110	3 3/4"	3 Hole	1000	\$ 98.10
H111	3 3/4"	3 Hole	200	\$ 24.78

Item #	Size	Type	QTY/Box	Each	3 Boxes+
1061B	1 1/2"	2 Hole	1000	\$ 83.72	
1062B	1 1/4"	1 Hole	1000	\$ 69.27	
1221	7/8"	1 Hole	2000	\$ 83.74	\$ 77.87
1222	1 1/8"	1 Hole	2000	\$121.19	\$112.71



Flangers

For securely hanging the narrowest of wood mouldings, Flangers are designed to prevent bowing and pull-outs due to weight related stress. Available in Narrow, Medium, and Wide.

Item #	Description	Each Box	3 Boxes+
932	Narrow • 50 Sets/Box	\$ 19.45	\$ 18.45 ea.
938	Medium • 50 Sets/Box	\$ 19.45	\$ 18.45 ea.
939	Wide • 40 Sets/Box	\$ 19.45	\$ 18.45 ea.
932B	Narrow • 500 Sets/Box	\$145.14	\$137.88 ea.
938B	Medium • 500 Sets/Box	\$145.14	\$137.88 ea..
939B	Wide • 400 Sets/Box	\$145.14	\$137.88 ea.

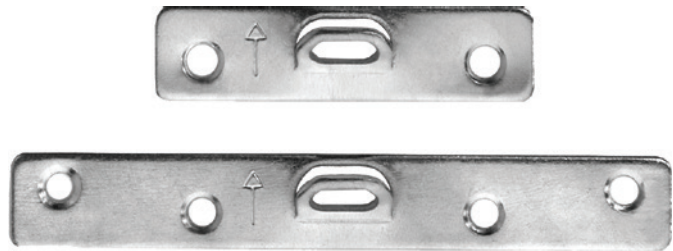

Steel Super Hangers

Steel Super Hangers eliminates cracking and pull outs of narrow and shallow mouldings, where strap hangers may be too wide and screw-eyes are insufficient. Screw support above and below wire loop ensures balance of pressure to reduce stress on moulding. Use #6 Philips screws (not included). • 100 hangers per box.

Item #	Size	Type	QTY/Box	Each
H112	2"	2 Hole	100	\$ 6.99
H113	3 1/2"	4 Hole	100	\$ 9.86

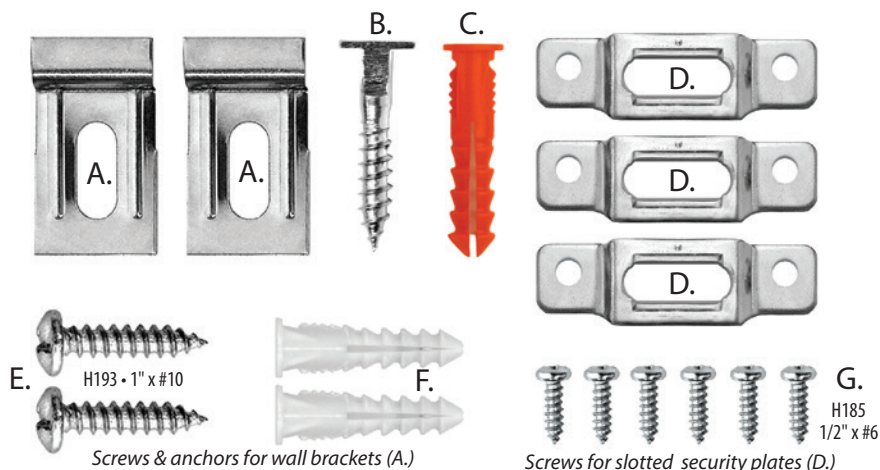

Screws & anchors for wall brackets (A.)

Screws for slotted security plates (D.)

Security Hangers Set for Wood Frames

Security hangers include special brackets that attach to the frame, wall brackets, and a special T-Headed screw which locks into the slotted security plate. Hanging requires specially designed security wrench (Sold separately: see bottom of page) which turns the T-Screw 90° while hung. Polybagged set includes parts shown above: 2 wall brackets with screws and wall anchors (A), T-Screw with wall anchor (B & C), 3 slotted brackets for wood frame (screws included).

Bulk quantity box of 100 sets available (Item H138)

Set consists of components shown above:

- A. Wall Support Brackets (2)
- B. T-Screw (1)
- C. Wall Anchor for T-Screw (1)
- D. Slotted Security Plates (3)
- E. 1" x #10 screws (2)
- F. Wall Anchors for 1" x #10 screws (2)
- G. 1/2" x #6 screws for slotted plates (6)

Item #	Description	Each Bag/Set	25+ sets
H136	Wood Security Hanger Set	\$1.13	\$1.03

Item #	Description	Each Box
H138	Bulk box of 100 wood security hanger sets	\$75.49

• Volume pricing available

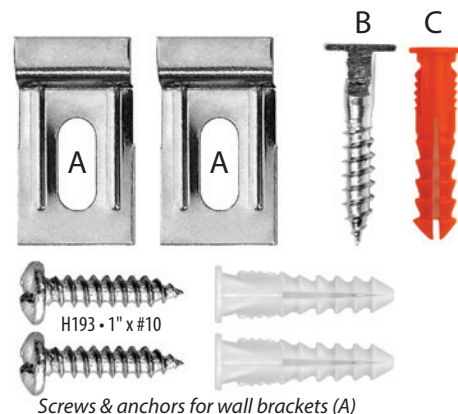

Screws & anchors for wall brackets (A)

Security Hangers Set for Metal Frames

Security hangers sets for metal frames include wall brackets with screws and anchors, and the T-Headed screw which locks into the back channel of a metal frame. Hanging requires specially designed security wrench (Sold separately: H140, or H141) which turns the T-Screw 90° while hung.

Polybagged set includes parts shown above: 2 wall brackets with screws and wall anchors (A), and T-Screw with wall anchor (B & C).

Bulk quantity box of 100 sets available (Item H139)

Item #	Description	Each Bag/Set	25+ sets
H137	Metal Security Hanger Set	\$0.75	\$0.67

Item #	Description	Each Box
H139	Bulk box of 100 metal security sets	\$49.99

Security System Hardware Components

A: Wall Support Bracket

- 10 per pack
- Can be used with metal or wood security system

Item #	Description	Each Bag/Set
H228	10 Wall Brackets	\$0.96

B: T-Screw

- 10 per pack
- Can be used with metal or wood security system
- Also can be used with Omega Cleat system

Item #	Description	Each Bag/Set
H227	10 T-Screws	\$2.28

C: Wall Anchors for T-Screw

- 10 per pack
- Sized for use with T-Screws (H227)

Item #	Description	Each Bag/Set
H230	10 T-Screw Wall Anchors	\$0.79

F: Anchors for #10 Screws (wall support bracket)

Item #	Description	Each Bag/Set
H231	10 Wall Anchors for #10 screws	\$0.75

D: Slotted Security Plate

- 10 per pack
- For use with wood security system
- Attaches to back of wood frames

Item #	Description	Each Bag/Set
H229	10 Slotted Plates	\$0.96

E & G: Screws

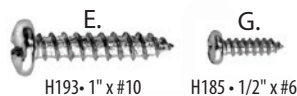

Size	Item#	200 QTY	Item#	1000 QTY
1" x 10	H193	\$ 7.78	H192	\$31.33
1/2" x 6	H185	\$ 2.64	H184	\$ 9.79

Security Bracket Picture Hanger

Designed for wood frames, this two-piece system securely hangs heavy frames and mirrors. The frame mounting bracket screws into the back of the frame, positioned with the prong down. The wall mounted bracket catches the prong to interlock the unit supporting and securing its weight and placement. Mechanism is not permanently locking, to allow for cleaning, painting, or maintenance. Screws sold separately. Screws needed for frame mounting bracket (4) 1/2" #6 wood screws. 4 screws needed for wall bracket will vary by picture weight. (1" #6 screws recommended).

Item #	Description	Each Bag/Set
3020	Bracket for 1 frame	\$0.97

Item #	Description	Each Box	5 or more
H244	Brackets for 100 frames	\$82.41	\$70.01



Security Wrench

Locking wrench for turning T-Screw in wood or metal security hanging systems. (2 sizes)

Item #	Description	Each
H140	7" Security Wrench	\$1.44
H141	9.5" Security Wrench	\$3.43



All pictured actual size



Zinc Plated Screw Eyes

Screw eyes made of zinc-plated steel for screwing into wood frames to attach wire for hanging. Available in short shank for standard depth picture frames and long shank for taller profiles and in boxes of 200 or 1000 pieces.

SHORT SHANK

Item #	Description	Each Box
H142	217 1/2 - 200 qty box	\$ 2.40
H144	216 1/2 - 200 qty box	\$ 2.51
H146	215 1/2 - 200 qty box	\$ 2.51
H148	214 1/2 - 200 qty box	\$ 2.51
H150	213 1/2 - 200 qty box	\$ 2.73
H152	212 1/2 - 200 qty box	\$ 2.85
H154	211 1/2 - 200 qty box	\$ 3.90
H156	210 1/2 - 200 qty box	\$ 4.94

Item #	Description	Each Box	5 Boxes+
H143	217 1/2 - 1000 qty box	\$10.45	\$ 9.41 ea.
H145	216 1/2 - 1000 qty box	\$10.45	\$ 9.41 ea.
H147	215 1/2 - 1000 qty box	\$10.45	\$ 9.41 ea.
H149	214 1/2 - 1000 qty box	\$10.62	\$ 9.56 ea.
H151	213 1/2 - 1000 qty box	\$11.00	\$ 9.90 ea.
H153	212 1/2 - 1000 qty box	\$12.11	\$10.89 ea.
H155	211 1/2 - 1000 qty box	\$13.76	\$12.38 ea.
H157	210 1/2 - 1000 qty box	\$19.82	\$17.84 ea.

LONG SHANK

Item #	Description	Each Box
H158	216 - 200 qty box	\$ 2.73
H160	214 - 200 qty box	\$ 3.29
H162	212 - 200 qty box	\$ 4.17

Item #	Description	Each Box	5 Boxes+
H159	216 - 1000 qty box	\$14.27	\$12.84 ea.
H161	214 - 1000 qty box	\$12.05	\$10.85 ea.
H163	212 - 1000 qty box	\$18.17	\$16.35 ea.

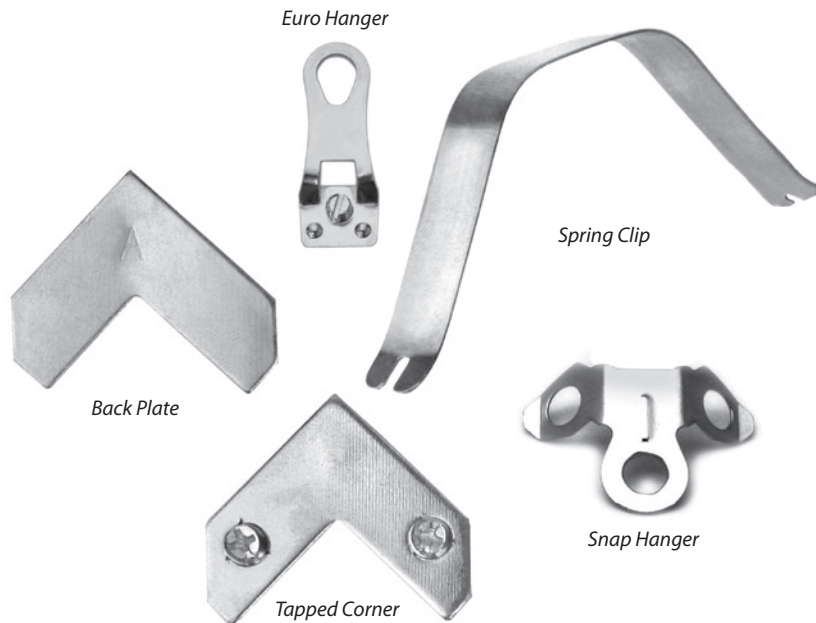

Tapped Angles

Joins corners on metal frames with no back plate needed. Screws apply pressure on back.

Item #	Description	Each Bag/Set
4031C	400 pieces per pack	\$ 56.47
4032B	1000 pieces per pack	\$122.15

Metal Frame Hardware

Universal metal frame hardware fits a variety of the most popular manufacturer's metal profiles. Available in polybagged sets or as individual parts to stock your supply needs.

Item #	Description	Each Pack/Set
H125	Metal Frame Hardware • 1 frame polybag w/ EURO	\$ 1.03
H124	Metal Frame Bulk Pack • 100 Frame Pack w/ EURO	\$71.65
H245	Metal Frame Bulk Pack • 100 Frame Pack w/SNAP	\$69.11
4030	Tapped Corners • 100 Pieces per pack	\$ 9.07
H116	Tapped Corners • 1000 Pieces per pack	\$76.06
4030A	Corner Back Plates • 100 pieces per pack	\$ 3.20
H118	Corner Back Plates • 1000 pieces per pack	\$18.71
H121	Euro Hangers • 200 pieces per pack	\$12.87
H120	Euro Hangers • 1000 pieces per pack	\$55.06
H122	Spring Clips - 3/8" • 1000 clips per pack	\$19.77
5013B	Spring Clips - 1/4" • 1000 clips per pack	\$27.35
4031B	Snap Hangers • 1000 pieces per pack	\$22.30



Articulated Angles

Angles that can be adjusted to any varying degree to join unique shapes with custom cut metal frames. Comes with 8 top plates w/screws and 16 bottom plates.

Item #	Description	Each Bag/Set
4028C	8 angles w/ 16 plates	\$5.72



Offset Clips

Offset clips are the solution to fitting subject matter that exceeds the depth of a frame. Most common applications include fitting stretched canvases, liners, stacked frames, shadowboxes and 3-dimensional art. Offsets have 2 holes for maximum versatility. **Nickel plated.** (Mounting screws not included; screw size should be determined by frame depth.)

2-HOLE OFFSETS

Item #	Height/QTY	Each Box	5 Boxes+
H233	1/8" H - 1000 qty box	\$22.03	\$19.82
H234	3/8" H - 1000 qty box	\$31.95	\$28.75
H235	1/2" H - 1000 qty box	\$31.95	\$28.75
H172	3/4" H - 100 qty box	\$ 4.44	\$ 4.00
H173	3/4" H - 1000 qty box	\$37.46	\$33.72
H174	1" H - 100 qty box	\$ 4.56	\$ 4.11
H175	1" H - 1000 qty box	\$38.57	\$34.70

2-HOLE OFFSETS

Item #	Height/QTY	Each Box	5 Boxes+
H164	1/8" H - 100 qty box	\$ 3.01	\$ 2.71
H166	1/4" H - 100 qty box	\$ 3.01	\$ 2.71
H167	1/4" H - 1000 qty box	\$22.03	\$19.82
H168	3/8" H - 100 qty box	\$ 4.34	\$ 3.91
H170	1/2" H - 100 qty box	\$ 4.34	\$ 3.91

Nickel Plated Steel Wood Screws with Super Sharp Tip!

PAN HEAD Phillips Screws



FLAT HEAD Phillips Screws



Wood Screws

Nickel plated steel wood screws for a variety of every day framing applications. Pan head screws with Phillips screw drive head for general use, and flat head Phillips drive screws for countersinking.

200 and 1000 quantity boxes



Size	Item#	200 QTY	Item#	1000 QTY
6 x 3/8	H183	\$ 2.57	H182	\$ 8.36
6 x 1/2	H185	\$ 2.64	H184	\$ 9.79
6 x 3/4	H187	\$ 2.96	H186	\$11.05
8 x 1/2	H189	\$ 4.35	H188	\$14.29
8 x 5/8	-----	-----	5641T	\$23.47
8 x 3/4	H191	\$ 6.30	H190	\$19.54
10 x 1	H193	\$ 7.78	H192	\$31.33
4 x 1/2 (f)	H177	\$ 2.61	H176	\$ 9.68
6 x 1/2 (f)	H181	\$ 2.69	H180	\$11.55

(f)= flathead

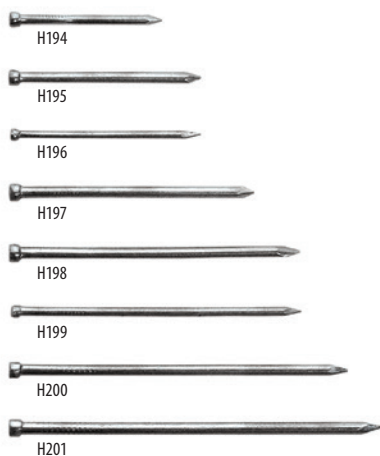

Wire Brads

1 lb. boxes.

Item #	Size	Finish	Each Box
H194	3/4" x 18	Bright	\$ 6.85
H195	1" x 17	Bright	\$ 6.85
H196	1" x 19	Bright	\$ 6.85
H197	1 1/4" x 17	Bright	\$ 6.85
H198	1 1/2" x 16	Bright	\$ 6.85
H199	1 1/2" x 18	Bright	\$ 6.85
H200	1 3/4" x 17	Bright	\$ 6.85
H201	2" x 16	Bright	\$ 6.85



Sawtooth Hangers

Steel sawtooth hangers in 2 sizes attaches to wood frames with included nails.

Item #	Description	Each Box
H130	1000 qty 1 3/4" sawtooth w/nails	\$15.28
H131	100 qty 1 3/4" sawtooth w/nails	\$ 2.00
H132	1000 qty 2 5/8" sawtooth w/nails	\$22.08
H133	100 qty 2 5/8" sawtooth w/nails	\$ 2.22



Nailless Sawtooth Hangers

Sawtooth hangers attaches to wood frames without use of nails. Can be driven by hammer or by using Sawtooth Insert Tool (item # H134).

Item #	Description	Each Box
H126	1000 qty 7/8" nailless sawtooth	\$19.28
H127	100 qty 7/8" nailless sawtooth	\$ 3.30
H128	1000 qty 1 3/4" nailless sawtooth	\$25.49
H129	100 qty 1 3/4" nailless sawtooth	\$ 4.40





Mending Plates

Mending Plates are designed for reinforcing, attaching, and connecting wood sections. They can be used to reinforce flat surface joints and seams as well as connect or reinforce stacked frames.

Nickel or Brass finish

2" and 3 1/2" sizes, 200 quantity pack.

(Screws sold separately.)

Item #	Description	1 Box	3+ Boxes
3800	200 ct. 2" (2-hole) nickel	\$19.28 ea.	\$17.93 ea.
3801	200 ct. 3 1/2" (4-hole) nickel	\$29.54 ea.	\$27.47 ea.
3805	200 ct. 2" (2-hole) brass	\$26.86 ea.	\$24.85 ea.
3806	200 ct. 3 1/2" (4-hole) brass	\$34.19 ea.	\$31.65 ea.

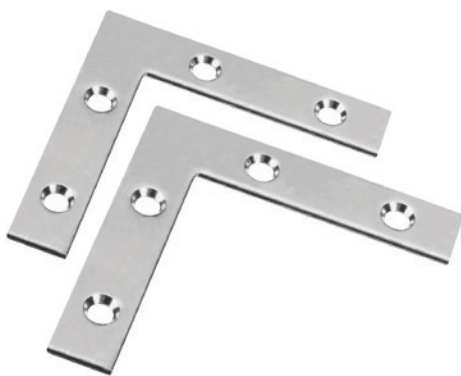

Corner Angles

Flat corner angles are designed to reinforce flat right-angle corner joints, making it ideal for use on larger frames to ensure stability. The 1 1/2" and 2" braces have a satin finish that will resist tarnishing and rust.

1 1/2" and 2" sizes, 100 qty pack.

(Screws sold separately.)

Item #	Description	Each Pack
H114	100 1 1/2" corners	\$ 9.86
H115	100 2" corners	\$10.96



Turnbuttons

Nickel plated turnbuttons are essential to framing projects with replaceable subject matter such as document, portrait, and table frames. Raised crest on one side can be used to apply more pressure to backing or easelback.

3/4" and 1" sizes, 1000 quantity pack.

(Screws sold separately.)

Item #	Description	Each Bag/Set
4327	1000 3/4" Turnbuttons	\$11.51
4328	1000 1" Turnbuttons	\$13.53

Nails included



Bulk Picture Hooks w/ nails

Quality nickel plated picture hooks with nails in bulk quantity packs of 1000.

Item #	Description	Each Pack 
H207	1000 10 lb. hooks w/nails	\$11.78
H208	1000 20 lb. hooks w/nails	\$13.22
H209	1000 30 lb. hooks w/nails	\$20.90
H210	1000 50 lb. hooks w/nails	\$34.93
H211	1000 100 lb. hooks w/nails	\$37.36



Courtesy Pack Polybagged Picture Hooks

Quality nickel plated picture hooks with nails individually polybagged with goodwill message for your custom framing customers.

Available in 5 sizes in 100 quantity boxes. 

Item #	Description	Each Box	4 Boxes+
H202	10 lb hook - 100 qty box	\$ 4.13	\$ 3.62
H203	20 lb hook - 100 qty box	\$ 4.23	\$ 3.73
H204	30 lb hook - 100 qty box	\$ 4.39	\$ 3.86
H205	50 lb hook - 100 qty box	\$ 5.50	\$ 4.84
H206	100 lb hook - 100 qty box	\$ 7.27	\$ 6.39



Double-Head Bear Claw Hanger

Self-drilling continuous thread steel screw with space for hanging wire. Holds 30 lbs. in drywall and 100 lbs. in a stud. Great for hanging with D-Rings and sawtooth hangers.

Item #	Description	Each Pack
1870	25 Double-Head Hangers	\$ 6.69



Brass Picture Hooks

Attractive and strong brass plated picture hooks come with brass head tempered steel nails.

Available in 5 sizes, in 100 individual polybags or unbagged bulk sets of 100 hooks.

Nails included for each hanger.

100 polybagged hangers (items 4555A-E)

100 unbagged hangers (items 4558A-E)

Polybagged Sets			Bulk-Unbagged	
Item#	Per Box	Size	Item#	Per Box
4555A	\$37.51	10 lbs.	4558A	\$35.44
4555B	\$42.17	20 lbs.	4558B	\$38.80
4555C	\$50.62	30 lbs.	4558C	\$40.49
4555D	\$70.85	50 lbs.	4558D	\$59.05
4555E	\$87.73	75 lbs.	4558E	\$70.85



Moulding Hooks

Brass plated hooks designed to hang from decorative wall moulding ledge. Moulding Hooks fasten directly to your wall moulding and hold either a hanging wire, filament cord, or picture frame wire. With the moulding at ceiling height or eye level, this hook is a quick option for hanging your art.

Moulding hooks are not designed to use with stainless cable systems nor with vertical hanging rods.

Item #	Description	Each Box
1048A	100 Narrow Hooks	\$20.19
1048B	100 Wide Hooks	\$20.19

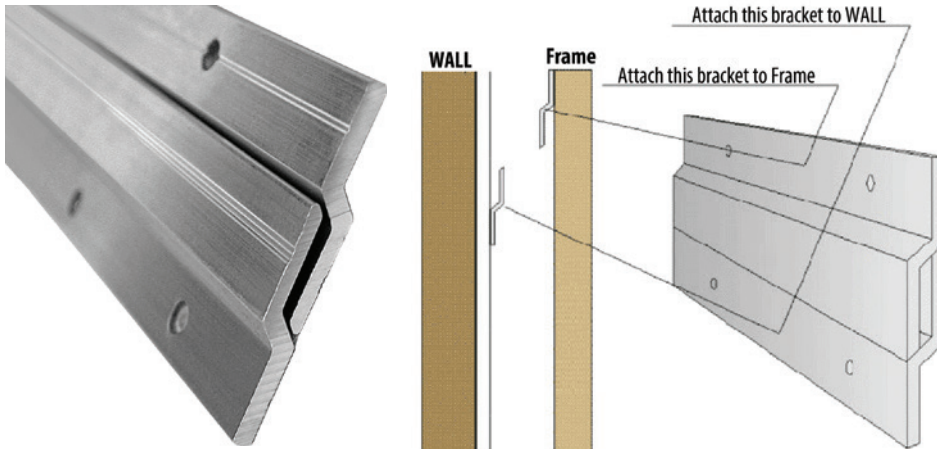

Omega Cleat Hanging System

Designed to hang large, oversized and heavy objects, the Cleat hanging system is the #1 solution achieving secure, level and flush picture hanging. The system works by interlocking two bars: one for the frame and one for the wall. Use a level when attaching the wall bar to ensure a perfect hang. Made of 100% extruded aluminum with multiple 3/16" pre-drilled holes every 4 inches for easy stud positioning. For maximum strength and weight distribution, attach into wall studs. Aluminum bars can be cut to size with hand or power saw. Available in 2 weights: Regular for under 90 lbs., and Heavy for over 90 lbs. Can be used with security hardware H227, H229, and H230. Screws not included.

Item #	Package Description	Each Pkg	4 Pkgs+
HZ1224	(Regular) 12" Bars: 24 Pcs.	\$27.63	\$25.42
HZ1224H	(Heavy) 12" Bars: 24 Pcs.	\$40.53	\$37.29
HZ2412	(Regular) 24" Bars: 12 Pcs.	\$27.63	\$25.42
HZ2412H	(Heavy) 24" Bars: 12 Pcs.	\$40.53	\$37.29
HZ368	(Regular) 36" Bars: 8 Pcs.	\$27.63	\$25.42
HZ368H	(Heavy) 36" Bars: 8 Pcs.	\$40.53	\$37.29
HZ486	(Regular) 48" Bars: 6 Pcs.	\$27.63	\$25.42
HZ486H	(Heavy) 48" Bars: 6 Pcs.	\$40.53	\$37.29

Item #	Bulk Quantity Set	Each Pkg.
HZ96	(Regular) 58" Bars: 20 Pcs.	\$58.42
HZ96H	(Heavy) 58" Bars: 20 Pcs.	\$99.21

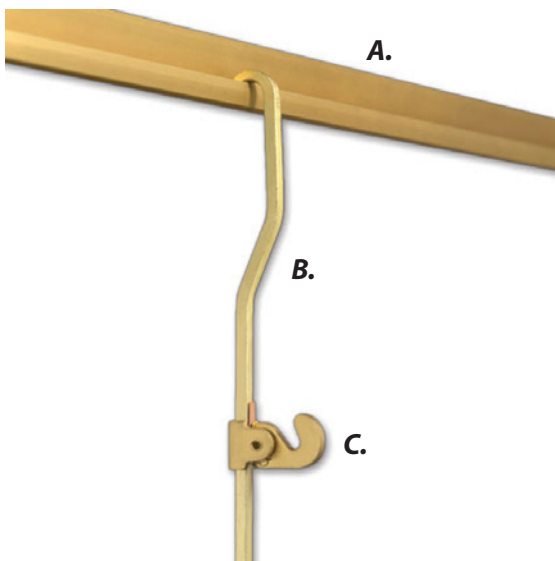

Detail of Brass Rod Hook (Monkey Hanger)

French Gallery Rod System Parts (as shown on left): (A) Brass J-Channel Wall Bracket, (B) Brass Gallery Rod, (C) Brass Monkey Hanger (detailed above).

French Gallery Rod System

Engineered for uncompromising durability and beauty, the Gallery Rod system is a unique and efficient hanging solution for collections and group/gallery displays. Three-part system consists of an adjustable hook that attaches on a solid brass rod which hangs from a J-Channel bracket mounted on the wall. This allows for easy mobility and repositioning of framed pieces. Rods and channels can be easily modified to size using a hack saw.

Item #	Description	Each
5580	Brass Monkey Hanger	\$ 8.89
5581	J-Channel (6 feet)	\$10.93
5585	6 ft. Gallery Rod w/ 1 hanger	\$17.71
5586	8 ft. Gallery Rod w/ 1 hanger	\$19.09



Chartpak Touch-Up Markers

Industry favorite Chartpak markers are specially formulated containing wood stains of the most popular finishes. Great for touching up join lines and cut edges, or blemishes on old frames. Markers come equipped with the Tri-Nib marker point, allowing precision with fine, medium, and broad tip all-in-one. Color tones can be refined by using Chartpak's Blending Marker (item CPFTMO). Sold individually (see below) and in sets.

Individual Colors

Item #	Color	Each Marker
CPFTM105	Ice Blue	\$3.40
CPFTM122	Grass Green	\$3.40
CPFTM139	Light Oak/Maple	\$3.40
CPFTM148	Light Pine	\$3.40
CPFTM160	Salmon	\$3.40
CPFTM20	Evergreen	\$3.40
CPFTM29	Leaf Green	\$3.40
CPFTM4	Ultramarine	\$3.40
CPFTM42	Cadmium Yellow	\$3.40
CPFTM5	True Blue	\$3.40
CPFTM54	Dark Walnut	\$3.40
CPFTM58	Dark Oak	\$3.40
CPFTM6	Prussian Blue	\$3.40
CPFTM60	Walnut Mahogany	\$3.40
CPFTM69	Dark Cherry	\$3.40
CPFTM70	Medium Oak	\$3.40
CPFTM74	Medium Cherry	\$3.40
CPFTM82	Crimson	\$3.40
CPFTM85	Maroon	\$3.40
CPFTM86	Red Mahogany	\$3.40
CPFTM90	Wine Red	\$3.40
CPFTM99	Black	\$3.40
CPFTMO	Blending Marker	\$3.40



Chartpak Touch-Up Sets

• Chartpak 25-marker Set

Item #	Description	Each
CPFTM25	Set of 25 Markers	\$82.72

Chartpak 9-color Wood Tone Set

Item #	Description	Each
CPFTM9	Set of 9 wood	\$23.71





• Nail Hole & Corner Filler 2 oz. tins



• Nail Hole & Corner Filler 1 lb. Jars

Nail Hole & Corner Filler

Amaco Nail Hole and Corner Filler is a pliable filler for nail holes, corners, cracks, and crevices in wood frames and will not dry out or shrink. Colors can be mixed to match. 2 oz. tins & 1 lb. jars.

2 Ounce Tins

Item #	Color	Each	Item #	Color	Each
NHF21408	Orange	\$ 9.63	NHF21419	White	\$ 9.63
NHF21409	Yellow	\$ 9.63	NHF21420	Light Oak	\$ 9.63
NHF21410	Turquoise	\$ 9.63	NHF21421	Blonde Maple	\$ 9.63
NHF21411	Walnut	\$ 9.63	NHF21422	Red Maple	\$ 9.63
NHF21412	Natural	\$ 9.63	NHF21423	Dk. Provincial Maple	\$ 9.63
NHF21413	Red	\$ 9.63	NHF21424	Dark Walnut	\$ 9.63
NHF21414	Green	\$ 9.63	NHF21425	Medium Maple	\$ 9.63
NHF21415	Blue	\$ 9.63	NHF21426	Grey	\$ 9.63
NHF21416	Mahogany	\$ 9.63	NHF21427	Gold	\$10.95
NHF21417	Ivory	\$ 9.63	NHF21428	Silver	\$ 9.63
NHF21418	Black	\$ 9.63	NHF21429	Dark Gold	\$10.95

1 lb. Jars

Item #	Color	Each	Item #	Color	Each
NHF21458	Orange	\$16.68	NHF21470	Light Oak	\$16.68
NHF21461	Walnut	\$16.68	NHF21471	Blonde Maple	\$16.68
NHF21462	Natural	\$16.68	NHF21473	Dk. Provincial Maple	\$16.68
NHF21463	Red	\$16.68	NHF21474	Dark Walnut	\$16.68
NHF21464	Green	\$16.68	NHF21475	Medium Maple	\$15.62
NHF21465	Blue	\$16.68	NHF21476	Grey	\$16.68
NHF21466	Mahogany	\$16.68	NHF21477	Gold	\$23.72
NHF21467	Ivory	\$16.68	NHF21478	Silver	\$16.68
NHF21468	Black	\$16.68	NHF21479	Dark Gold	\$23.72
NHF21469	White	\$16.68			



Rub 'N Buff

Rub 'n Buff is formulated from carnauba waxes, fine metallic powders, and select pigments, for touching up metallic finishes on frames or embellishing highlights. Can be blended to achieve desired finish. 0.5 oz (15ml) tubes 

- RNB76361 Gold Leaf
- RNB76362 Antique Gold
- RNB76366 Antique White
- RNB76368 Spanish Copper
- RNB76369 Ebony
- RNB76370 Silver Leaf
- RNB76371 Grecian Gold
- RNB76372 Autumn Gold
- RNB76379 European Gold
- RNB76380 Pewter

Description	Each	12 assorted+
Rub 'n Buff • .5 oz. Tube	\$3.91	\$3.73 ea.



Brush 'N Leaf

Brush 'n Leaf Metallic Finishes go on easily with one application. Just brush it on any clean, dry & solid surface. The exclusive Brush 'n Leaf formula features metallic flakes that "leaf" into a solid, shiny metallic look that dries quickly to a durable finish. Great for touching up brighter metal leaf finish frames. 1 oz. jar 

Item #	Color	Each	12 assorted+
BNL76630	Gold Leaf	\$6.71	\$6.18 ea.
BNL76631	Antique Gold	\$6.71	\$6.18 ea.
BNL76632	Silver Leaf	\$6.71	\$6.18 ea.



Treasure Gold

In one simple step, Treasure Gold® gives any project a rich metallic luster as beautiful as precious metals themselves. Just rub on for glimmering highlights or to touch up gold leaf finishes. 3 ml. container 

- 4144-1 Classic Gold
- 4144-2 Florentine Gold
- 4144-7 Pewter
- 4144-8 Silver

Description	Each
Treasure Gold • 3 ml	\$4.15



Liquid Leaf

Liquid Leaf helps create the beauty of traditional leafing with brush on ease. Paint combines an undercoating with metallic color for a brilliant, long lasting finish. Use on wood, metal, glass, ceramics, paper, plaster or plastic. 3/4 oz. jar 

- 4145-1 Gold
- 4145-2 Florentine Gold
- 4145-3 Renaissance Gold
- 4145-5 Brass
- 4145-6 Copper
- 4145-8 Silver

Description	Each
Liquid Leaf • 3/4 oz	\$6.71



Z-Gel Texturizing Finishing Medium

Z-Gel is the one step texturing process for posters, prints, and pre-treated photos, is a great alternative to canvas transfers, and eliminates the need for glass. You control the brush-stroked appearance. No prep work needed, simply mount prints directly on firm substrate and apply the Z-Gel gloss medium with a brush to create painterly or stippled effects. Cleans up with soap and water.

Gloss or Semigloss finish, 32 fluid oz. or 1 Gallon 

Item #	Size/Description	Each
ZG32G	Gloss Z-Gel Medium, 32 oz.	\$28.41
ZG32S	Semigloss Z-Gel Medium, 32 oz.	\$28.41
ZG64G	Gloss Z-Gel Medium, Gallon	\$66.79
ZG64S	Semigloss Z-Gel Medium, Gallon	\$66.79



Z-Crackle Antiquing Medium Starter Kit

Z-Crackle Finish provides an excellent antique crackling system for posters, prints and eliminates the need for glass. You control the thickness of the cracks through the application of the Step 1 finish. Mount prints directly to illustration board and other firm substrate. Z-Crackle Finish creates a 100% acrylic polymer emulsion, yielding excellent flexibility and water protection. Cleans up with soap and water. *Not suggested for photographs or giclee prints. Kit includes items shown:*

16 oz. Step 1 Crackle Finish, 16 oz. Step 2 Crackle Activator, 2 oz. Antiquing Polish, and sponge brush

Item #	Size/Description	Each
ZCKIT	Z-Crackle Starter Kit	\$54.64



Solid Panel Velour Easel Back



Door-Hinged Velour Easel Back

Velour Easel Backs 

High quality flocked velour easel backs are constructed with the sturdiest substrate in the industry. Solid easelbacks come in a variety of standard sizes and can be trimmed for customization. Door-hinged easel backs are available in 4 sizes with door openings in standard sizes of 4x6, 5x7, 8x10, and 11x14. Hinged panels are equipped with turnbutton closures for easy fitting and refitting of contents. Velour easel backs are the ideal choice for constructing high-end table frames. *Easel stands vertically & horizontally. Pack of 6 Easel Backs*

• Premium Velour - Finest quality hand-wrapped velour

Item #	Size/Description	Per 6-Pack
2072B	5 x 7 Premium Velour	\$23.76
2072D	6 x 8 Premium Velour	\$25.07
2072F	8 x 10 Premium Velour	\$25.55
2072H	10x12 Premium Velour	\$30.28
2072K	11x14 Premium Velour	\$34.52
2072M	12x15 Premium Velour	\$43.12
2072P	14x18 Premium Velour	\$49.18
2072R	16x20 Premium Velour	\$60.61

• Value Velour - Great look for great price; ideal for contract production

Item #	Size/Description	Per 6-Pack	3 Pkgs.+
EBV46	4 x 6 Velour Easel Back	\$ 6.35	\$ 5.41 ea.
EBV57	5 x 7 Velour Easel Back	\$ 6.81	\$ 5.79 ea.
EBV810	8 x 10 Velour Easel Back	\$ 9.72	\$ 8.27 ea.
EBV1114	11x14 Velour Easel Back	\$13.69	\$11.64 ea.

• Hinged Door Velour Easel Backs - for easy access fitting & refitting

Item #	Size/Description	Per 6-Pack	3 Pkgs.+
EBVD46	4 x 6 door opening	\$10.30	\$ 8.76 ea.
EBVD57	5 x 7 door opening	\$12.60	\$10.71 ea.
EBVD810	8 x 10 door opening	\$19.43	\$16.52 ea.
EBVD1114	11x 14 door opening	\$29.75	\$25.28 ea.

Embossed Easel Backs 

Sturdy embossed leather-look easel backs are made of vinyl coated compressed card-core for durability and stability with thick easel stands reinforced with metal hinges. Available in standard sizes, panels can be easily cut to custom sizes. *Easel stands vertically & horizontally. Pack of 6 Easel Backs*



• Premium Embossed - High Quality Leather texture, thick stock

Item #	Size/Description	Per 6-Pack
2073C	5 x 7 Embossed Easel Back	\$ 7.36
2073D	6 x 8 Embossed Easel Back	\$ 8.20
2073E	8 x 10 Embossed Easel Back	\$10.06
2073F	10x12 Embossed Easel Back	\$11.05
2073G	11x14 Embossed Easel Back	\$13.23

• Economy Embossed - Top choice for high production work

Item #	Size/Description	Per 6-Pack	3 Pkgs.+
EB46	4 x 6 Embossed Easel Back	\$ 4.81	\$ 4.08 ea.
EB57	5 x 7 Embossed Easel Back	\$ 5.94	\$ 5.05 ea.
EB810	8 x 10 Embossed Easel Back	\$ 8.54	\$ 7.25 ea.
EB1114	11x14 Embossed Easel Back	\$10.59	\$ 9.00 ea.



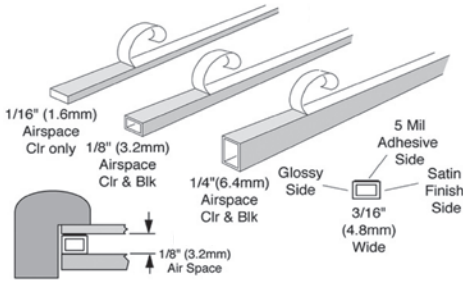

Econospace

Neutral pH hollow plastic "peel & stick" spacer that is used to make the proper airspace between the art and glass in either wood or metal picture frames. EconoSpace is easy to trim to size by hand. Clear, Black, or White. Bundled in 60' or 100' packs of 5-foot lengths. 3/16" wide strips in 4 spacer depths.

Item # Height-Color • total 1Pkg 3 or More

FRS-8	1/4" Clear • 60'	\$36.73	\$34.88
FRS-9	1/4" Black • 60'	\$36.73	\$34.88
FRS-5	1/16" Clear • 100'	\$45.90	\$43.61
5130B	1/16" Black • 100'	\$45.90	\$43.61
FRS-6	1/8" Clear • 100'	\$45.90	\$43.61
FRS-7	1/8" Black • 100'	\$45.90	\$43.61

Item # Height-Color • total 1Pkg 3-9 pkgs 10 +pkgs

5132C	1/4" White • 60'	\$45.23	\$38.88	\$36.58
5133	3/8" Clear • 60'	\$48.08	\$41.31	\$38.87
5133B	3/8" Black • 60'	\$48.81	\$41.95	\$39.48
5133C	3/8" White • 60'	\$47.32	\$40.67	\$38.26
5131C	1/8" White • 100'	\$56.53	\$48.59	\$45.71

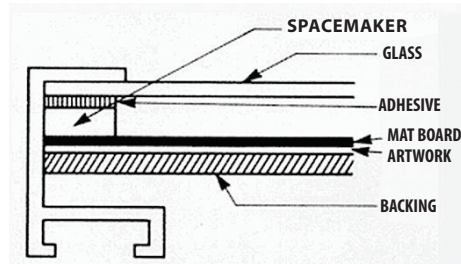

Spacemaker

An economical acid-free solid plastic picture frame spacer that is coated on one side with a strong pressure sensitive adhesive for ease of application. Can be stacked to increase height/space. Works equally well in both wood and metal frames. Available in 1/8" and 1/4" depths, each length is 3/16" wide x 58" long. Spacemaker can be easily cut to size by scoring and snapping by hand. Smoke, Black, or Clear

Item # Height-Color • total 1Pkg 3-9 pkgs 10 +pkgs

5151A	1/8" Smoke • 21 pcs	\$45.29	\$37.02	\$35.17
5151B	1/8" Black • 21 pcs	\$45.29	\$37.02	\$35.17
5151C	1/8" Clear • 21 pcs	\$45.29	\$37.02	\$35.17
5152A	1/4" Smoke • 11 pcs	\$32.04	\$26.51	\$25.18
5152B	1/4" Black • 11 pcs	\$32.04	\$26.51	\$25.18
5152C	1/4" Clear • 11 pcs	\$32.04	\$26.51	\$25.18

Rabbetspace

Rabbetspace is a simple yet ingenious full frame rabbet depth extender system. Neutral pH acrylic has a black satin finish. When backing projects with black foam board or mat board, you'll achieve a very professional looking appearance with no paper backing required. Also works beautifully with easel backs. 35 feet: (7) 5 ft. lengths per set. 150 matching black screws included.

Item # Height-Color • total 1 Pkg 3 + pkgs

FRS-1	1/8" Black • 35 feet	\$25.25	\$23.99
FRS-2	1/4" Black • 35 feet	\$26.41	\$25.07
FRS-3	3/8" Black • 35 feet	\$27.54	\$26.17
FRS-4	1/2" Black • 35 feet	\$28.69	\$27.26

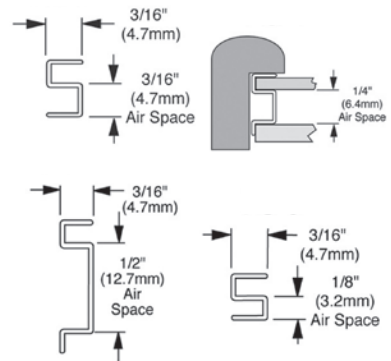
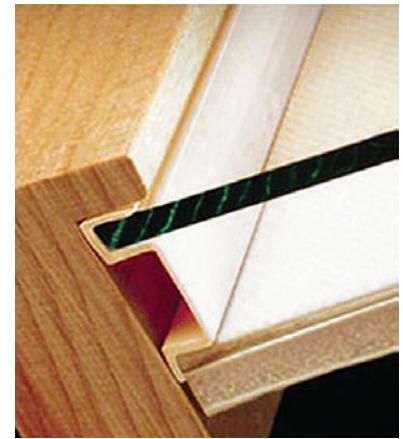

Framespace

Framespace is an adhesive-free plastic spacer that works by capping the edge of the glass and braces the rabbet of the frame, separating the glass from the surface of the artwork by 1/8" - 1/2". Plastic strips can easily be trimmed to size by hand using a blade. Clear, Black, or White. Bundled in 60' or 100' packs of 5-foot lengths. 3/16" wide strips of various spacer depths.

• Framespace fits on the edge of glass; consider the thickness of glass or acrylic when using Framespace.

Fits 2mm and 2.5mm glass :

Item # Height-Color • total 1Pkg 3-9 pkgs 10 +pkgs

5116	1/8" Clear • 100'	\$65.03	\$55.87	\$52.56
5116B	1/8" Black • 100'	\$65.03	\$55.87	\$52.56

Fits 2mm glass & 1/8" acrylic:

Item # Height-Color • total 1Pkg 3-9 pkgs 10 +pkgs

5111	3/16" Clear • 100'	\$65.03	\$55.87	\$52.56
5111B	3/16" Black • 100'	\$65.03	\$55.87	\$52.56
5111C	3/16" White • 100'	\$65.03	\$55.87	\$52.56

Fits 2.5mm glass & 1/8" acrylic:

Item # Height-Color • total 1Pkg 3-9 pkgs 10 +pkgs

5110A	3/16" Clear • 100'	\$65.03	\$55.87	\$52.56
5110B	3/16" Black • 100'	\$65.03	\$55.87	\$52.56
5110C	3/16" White • 100'	\$65.03	\$55.87	\$52.56
5114C	1/4" White • 60'	\$48.08	\$41.31	\$38.87
5112A	1/2" Clear • 60'	\$48.08	\$41.31	\$38.87
5112B	1/2" Black • 60'	\$48.08	\$41.31	\$38.87
5112C	1/2" White • 60'	\$48.08	\$41.31	\$38.87
5118A	1/2" Clear • 60'	\$48.08	\$41.31	\$38.87

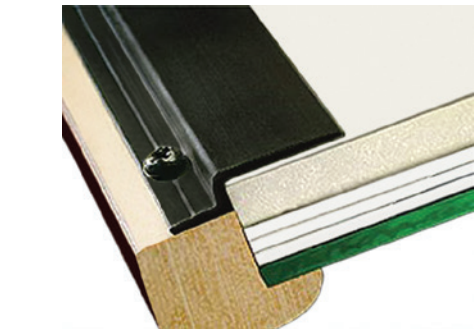



Self-Adhesive Bumpers

Non-marking, adhesive silicone bumpers keep the bottom corners of frames properly spaced out from the wall while helping to stabilize placement while hung. For use with wood (all items) and metal frames (H213) • 1000 per pack

Item #	Description	1 Pkg	5 + pkgs
H212	Clear Round • 1000pcs	\$26.54	\$23.16
H214	White Round • 1000pcs	\$26.54	\$23.16
H215	Black Round • 1000pcs	\$26.54	\$23.16
H216	Brown Round • 1000pcs	\$26.54	\$23.16
4211B	Brown Square • 1000pcs	\$26.54	\$23.16
<i>For Metal Frames</i>		1 Pkg	5 + pkgs
H213	Clear Sphere • 1000pcs	\$26.54	\$23.16

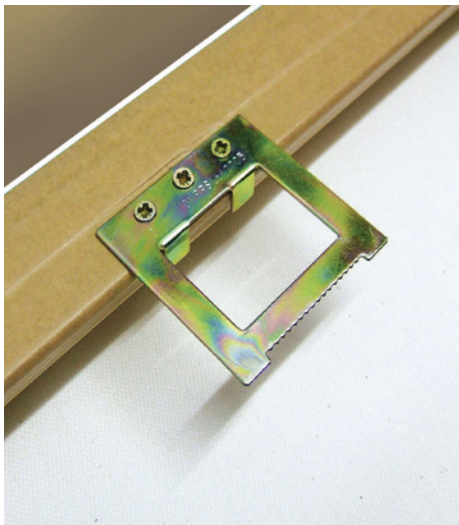

Canvas Wrap & Gallery Hangers

Canvas Gallery Wrap Hangers are designed for stretched canvases and frames with a recessed back. Gallery Hangers work with frames with a flush or papared back. Hangers for hollow backs fit stretchers and frames with hollow backs of 1/16" + deep, & moulding 3/4" + wide. Flush Back hangers have a protuded step to allow for wall hanger. *Screws not included*

Item #	Description	Each Pack
6925B	200 Gallery Wrap Hangers for stretchers/hollow back frames	\$52.17
6926B	200 Gallery Hangers for flush or papared frame backs	\$52.17



Hangman Heavy Duty Hanger

Hangman's Heavy Duty Hanger with Wall Dog® screws, quickly and easily hangs mirrors, pictures and wall decor up to up to 100 lbs. (10"), 200 lbs. (18") or 300 lbs. (30"). The Hangman System supplies all the hardware needed for wall installation and includes a handy removable bubble level. Brackets are made of strong heavy-duty aluminum. Mounting holes are punched on 4-Inch centers for easy installation into studs. *Polybagged for resale.*

Item #	Description	Each
1831D	10", 100 lb. hanger	\$ 7.12
1832D	18", 200 lb. hanger	\$10.02
1833D	30", 300 lb. hanger	\$11.39

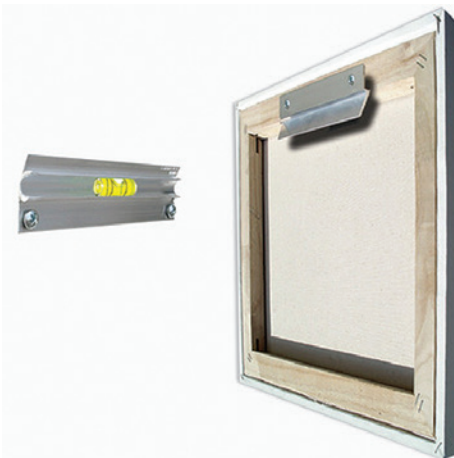

Hangman 5" Canvas Hanger

The Hangman Canvas Hanger is a two piece bracket system that hangs giclees, gallery wraps, canvas or open back frames flush to the wall. The wall track includes a bubble level for an accurate installation. *5 inch hanger holds up to 30 lbs.* 

Item #	Description	Each
1790	5", 30 lb. Canvas Hanger	\$ 3.75



KWIK Hangers

Kwik Hangers are a safe fast way to hang posters and signage mounted on foam or corrugated board. Bendable metal tab hangs easily. *100 hanger pack* 

Item #	Description	Each Pack	4 Packs+
4092	100 KWIK Hangers	\$ 6.94	\$ 6.25 ea.



Swiss Clips

Spring loaded arms clamp and hold together any thickness up to 3/8" combination of glass, picture, mat, and backing. Requires the rigidity of the glass and backing board. Clips can be use to frame any size within 30" x 30" plus one hanger bracket.

Item #	Description	Each
4737	Pack of 4 Clips	\$ 3.89
4739	Bulk Pack of 100 Clips	\$75.21



Swiss Corner Clips

Corner Clips work with a nylon cord, holding its contents together by tension. Holds together any thickness up to 3/8" combination of glass, picture, mat, and backing. System can support up to 60 lbs. and up to 30" x 30". Kit includes four corner clips, cord, and hanger bracket.

Item #	Description	Each
4735	Swiss Corner Clips Kit	\$ 6.36
4734	150 ft. of Cord	\$ 6.21
4736	Bulk Pack of 60 Corners	\$67.64



Plastic ZiG-ZaG Hangers

Plastic Zig Zag hangers are the most popular way to hang foamboard mounted posters and signs. Simply peel the plastic tab, stick on the back, & hang on small nail or hook. *100 hanger pack*

Item #	Description	Each
5280	100 Zig Zag Hangers	\$14.85



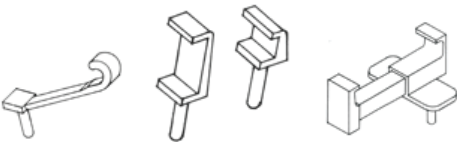
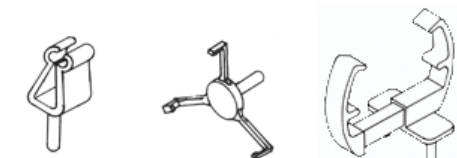

Plate Holder

Multi-purpose Holder

Knife Holder



Spoon Holder

Coin Holder

Gun Holder

Mighty Mounts

Using glue or wire adds time to the construction of a shadow box. This process can compromise or even damage the object and in time, the glue can give away, allowing the object to come loose in the frame. Mighty Mounts are polycarbonate pH neutral plastic devices that have a stem that is quickly and easily placed through mat board and foam board backing to hold the object securely in the shadow box. To assemble, first lay out your objects in a shadow box the way you want them to be viewed. Second, take an awl and place a hole at the desired location through the backing. Place the stem of the Mighty Mounts through the hole and place a speed nut on the back to hold it in place. Once your holders are in place, attach your object and it is ready to frame.

Item #	Description	Qty.	Each
4255	Spoon/ Object Clip Holder	12	\$ 8.78
4256	Knife Mount	1	\$ 8.78
4257	Coin Holder	12	\$ 8.78
4258	Gun Mount	1	\$ 8.78
4259	Multi-purpose Clip Holders	12	\$ 9.43
4260	Plate Holder / Bracket Clip	12	\$ 8.78



Center-Finding Tape Measure

Omega's solid-state 16-foot retractable center-finding tape measure is cased in a heavy-duty housing with handy metal belt clip and locking mechanism. Easily find your center with 1/2" increment-reads on the bottom of tape. 3/4" x 16' metal tape

Item #	Description	Each
UST1	Center Finding Tape Measure	\$ 7.67



Metal Straight Edge Rulers

Durable and reliable metal straight edges for the workshop or the design desk, these rulers are made of heavy-duty aluminum that stands up to years of wear and tear. Each is marked with easy-to-read gradations in American and/or metric units of measurement. 60" and 72" lengths

Item #	Description	Each
2025G	60" Metal Straight Edge	\$ 26.17
2025H	72" Metal Straight Edge	\$ 36.65



Burnishing Bone

Useful for smoothing bevels on mat cuts and equally handy for burnishing and creasing heavy papers, applying decorative tapes, and smoothing raised fibers on rag mats. No framer can be without it. 

Item #	Description	Each
N37325	6" Burnishing Bone	\$ 11.01

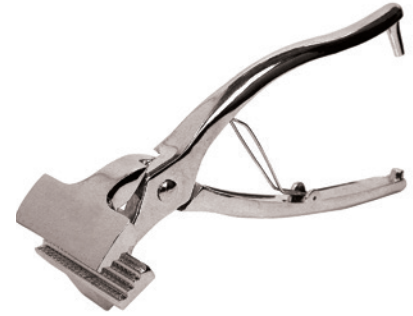

Chrome Canvas Pliers

These chrome-plated steel canvas pliers, are the most essential tool for mounting your own canvases. The spring-loaded serrated jaws keep a firm grip on the canvas and open to a width of 2 3/8".

Item #	Description	Each
CP7400	Chrome Canvas Pliers	\$18.65



Premium Canvas Pliers

This premium tool features rubberized handles for comfort and a non-slip spring-loaded rubberized jaw that won't tear or crimp the canvas. Made of chrome-plated steel and built to last, these pliers have become the framer's favorite for stretching canvases by hand.

Item #	Description	Each
CP7401	Premium Canvas Pliers	\$49.04



Super Shears by Dahle (8")

These commercial grade shears can handle the toughest material as well as the most delicate fabric. They feature Solingen steel cutting blades that are machine ground and hardened to 56 Rockwell. This specification is considered the optimal hardness of metal for maintaining a sharp edge, essential for the rigors of a frame shop.

Item #	Description	Each
6150	8" Dahle Super Shears	\$34.69



Alvin Dusting Brush

Traditional draftsman's dusting brush made of soft 100% sterilized horsehair, wax set in a durable 14½" wooden handle. Use for delicate dusting of artwork, platens, mats, foam boards, and glass.

Item #	Description	Each
DB100	Alvin Dusting Brush	\$ 5.87



Static Discharge Brush

Kintronics StaticWisk anti-static brush is used to brush away fine dust and debris from acrylic, glass, and other materials that attract dust. The unique blend of soft natural hairs and conductive synthetic fibers plus the conductive nature of the construction result in effective static dissipation.

Item #	Description	Each
255	StaticWisk anti-static duster	\$27.62



Grounded Anti-Static Brush

This Kintronics 4" StaticWisk Anti-Static Brush is equipped with a grounding cable which effectively removes any static charges from the surface. Brush can be cleaned with water and (if needed) mild detergent without this influencing their anti-static effect. Remove cable when cleaning.

Item #	Description	Each
25W	StaticWisk w/grounding cable	\$40.45



Cotton Gloves

For handling delicate items of value, these cotton gloves protect surfaces from fingerprints & oils. Made of unbleached stretched cotton that can be used multiple times.
6 pairs (12 gloves), One size fits most.

Item #	Description	Each
CG1200	Cotton Gloves 12-pack (6pr.)	\$ 8.41



Speck Grabber

Great for removing individual contaminants from delicate surfaces this narrow tool can get into and in between small spaces. When the Speck Grabber is put in contact with the particle, it adheres to the particle, while leaving no residue on the contacted surface. Tips can be cleaned with mild soap and water and comes in a handy storage tube.

2 Speck Grabber tools included

Item #	Description	Each
135SG	2 Speck Grabbers	\$12.46



Document Cleaning Pad

Specially formulated cleaning pad emits a super soft grit free powder which cleans by absorbing by surface dirt in the powder. After cleaning, residue is simply brushed away.

Item #	Description	Each	12 pads +
4507	Lineco Document Cleaning Pad	\$ 3.27	\$2.90



Sprayway Lint & Dust Remover

Pinpoint accuracy makes it easy to clean hard-to-reach places. Moisture-free air blasts away lint, dust, tiny fabric scraps, sawdust, etc. Leaves no film or residue. Great portable solution for precision removal of particles and debris, ideal for cleaning equipment such as mat cutters, wall cutters, dry mount presses, and anything around your frame shop.

10 oz., Non-flammable

Item #	Size	Each	12 +
SP805	10 oz. can	\$11.99	\$11.39 ea.



High Performance Microfiber Cloth

Polyester Micro Fiber absorbs up to 7 times its weight, traps dirt and dust, industrial strength, soft and absorbent, non-scratching, lint-free. Washable & reusable blue cloth in poly bags. Ideal for cleaning specialty and plain glass.

Available individually or in packs of 12

Item #	Description	Each
1980	Performance Microfiber Cloth (1)	\$ 5.46

Item #	Description	Each	5 pkgs.+
1982	Performance Microfiber 12-pack	\$45.76	\$40.08 ea.



Tiger Cloth® Anti-Static Cleaning Cloth

Special microfiber cloth that has been specifically engineered for cleaning photography, delicate artwork, acrylic and glass. The 10" x 18" orange cloth has stripes of effective conductive fibers knit every 1/8" that dissipate static charges.

Item #	Description	Each
131	Tiger Cloth anti static cloth	\$ 6.83





Wypall Heavy Duty No-Lint Wipes Roll

Jumbo roll of 950 cloth-like paper towels of the highest quality. The all-purpose towels are great for every use in the frameshop and are soft enough to use on specialty glass and acrylics without scratching the finish or leaving lint from paper fibers. Absorbant and strong enough to use multiple times before disposing saving resources, time and money. Roll stand available, Item WMA800 (below)

Item #	Description	Each	3+Rolls
WMA750	Wypall 950ct. Roll	\$83.73	\$76.20 ea.



Wypall Shop Stand Dispenser

Portable, high-capacity metal shop stand and dispenser for Wypall jumbo rolls of No-Lint wipes is compact enough for use in most any location around your workstations. Easel style folding frame stands on the floor at a comfortable convenient height. Easy loading and dispensing of rolls. 16.75" w x 18.5" d x 33" h

Item #	Description	Each
WMA800	Wypall Shop Stand Dispenser	\$66.14



Wypall L30 & L40 Wipes

Ideal for cleaning glass, acrylic, and a multitude of cleaning tasks. Strong and absorbant. One-at-a-time handy dispensing package. Manufactured using 40 percent post-consumer recycled fiber. L30 wipes are light weight, great for cleaning glass & equipment. L40 are softer and thicker; well-suited for cleaning acrylic and for multiple uses.

Wypall L30 General Purpose - 100 16.4" x 9.8" wipes.
Wypall L40 All-purpose - 100 16.4" x 9.8" wipes.

Item #	Description	Each	8+pkgs
4027	Wypall L30 Wipes • 100 ct.	\$15.81	\$15.37 ea.

Item #	Description	Each	9+pkgs
9217	Wypall L40 Wipes • 100 ct.	\$23.99	\$22.13 ea.



Wypall Heavy Duty No-Lint Wipes Box

Counter-Top box of 100 heavy-duty no-lint wipes is a great portable 'on-the-go' option for outfitting your workstations with these high-quality wipes. The all-purpose towels are great for every use in the frameshop and are soft enough to use on specialty glass and acrylics without scratching the finish or leaving lint from paper fibers. Absorbant and strong enough to use multiple times before disposing saving resources, time and money.

Item #	Description	Each	9 + boxes
WMA100	Box of 100 wipes	\$10.35	\$ 9.43 ea.



M-Tork Towels

Designed specifically for the Tork center feed towel dispenser system (Item 4020), these high-quality, highly absorbant paper towels are great for a multitude of uses around the workshop including glass cleaning or cleaning up glues and liquids near the joiner, where you need fast one-handed dispensing. Made from 100% recycled fiber, 600 sheets per roll

Item #	Description	Each	6+rolls	30+rolls
4021	M-Tork Towels	\$20.13	\$18.52 ea.	\$17.14 ea.

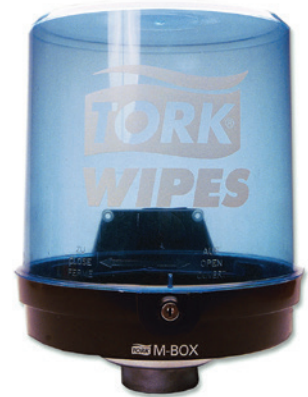

M-Tork Center-Feed Dispenser

The M-Box dispenser features a high-capacity, centerfeed towel dispensing system. It is ideal for workshops and other environments where cleaning wipes need to be easily accessible and easily dispensed single-handedly. System easlily loads and disributes perforated M-Tork towels for convenient use. Mounts to wall with provided hardware.

Item #	Description	Each	3 or more
4020	M-Tork Towel Dispenser	\$33.67	\$31.27 ea.



Glass Handling Gloves

These coated fabric gloves are covered with high quality embossed rubber offering durable protection, grip, and flexibility when handling glass.

1 pair • One size fits most.

Item #	Description	Each
--------	-------------	------

GLASGLOV Glass Handling Gloves (pair) \$ 4.54



Glass Cutter Hand Tool

This steel wheel hand held glass cutter is a reliable tool that allows you to freely make glass cuts using a straight edge or for freehand scoring special shapes. With a comfortable zinc die cast handle with ball ended shaft for easy pivoting, and slotted head for snapping edges.

Item #	Description	Each	6 or more
--------	-------------	------	-----------

H232 Glass Cutter hand tool \$ 1.82 \$ 1.64 ea.

DIAMANTOR



The original #1 TOP SELLER in the USA!

Diamantor® Glass Cutter

The Diamantor Wood Handle Glass Cutter features a precision ground steel cutting wheel set into a nickel plated cutting head which is attached to a solid wood handle.

Item #	Description	Each	12 or more
--------	-------------	------	------------

GC100 Diamantor Glass Cutter \$ 3.03 \$ 2.86 ea.



Acrylic Scoring Tool

This tool is used to score acrylic by hand. Also can be used to score tempered and corrugated cardboards. Scoring blade is double-beveled ground, and has a vinyl no-slip cushioned grip handle. Use with straight edge for precise scoring.

Item #	Description	Each
--------	-------------	------

PLEXCUT Acrylic scoring tool \$ 5.78 ea.



Glass Breaking Pliers

Used for "running" the glass along the score lines. Very light to use. Perfect for all levels of craftsman. Makes running your scores a snap.

Item #	Description	Each
--------	-------------	------

GLPL100 Glass Breaking Pliers \$ 9.88

Chip Breakers & Scrap Supports

In the event that a moulding is chipping on the back side in the process of being cut, there are a number of possibilities that could cause the the moulding to chip that is not the cause of defective moulding. Dull blades, a damaged blade tooth, cutting speed, a worn Chip Breaker or Scrap Support, etc. are all things that can contribute to chipping or blown-out cuts. Chipping and blow-out are undesirable rough-edge cuts where the wood or gesso gets chipped off of the back edge of the moulding as the saw blade exits through the surface. Some woods or gessos are more delicate and thus more subject to chipping than others. Chipping or blow-out mainly occurs when there is a gap (or void) between the blade and the Chip Breaker. Worn, overused Chip Breakers are the main cause of chipping and blow-outs and very rarely indicates bad moulding.

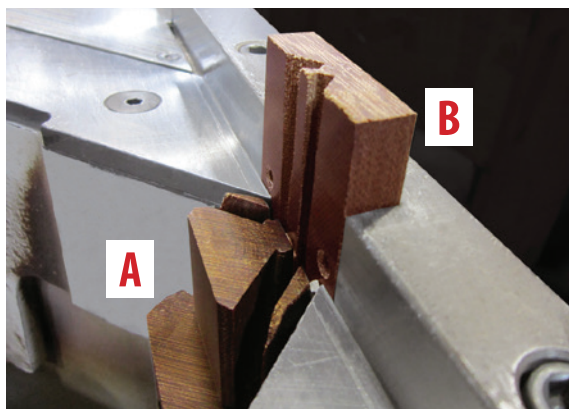

Scrap Support (A) and Chip Breaker(B) inserted in a double miter saw.



Scrap Support

Scrap Support

• For Pistorius Saws

A Scrap Support is a specially shaped piece of phenolic resin that sits into the throat of a double miter saw, that supports the area of moulding that is the miter cut of the moulding. The top of the support sits flush with the table providing a stable base which fills the void of the miter space. Primarily, the support keeps the miter scrap in place, keeping it from interfering with the blade. Additionally it prevents blowout and chipping on the bottom and bottom back edge by prohibiting downward movement of the moulding. Used in tandem with a viable Chip Breaker, you will achieve clean, consistent results at the saw.

Item #	Description	Each
--------	-------------	------

SCRAPSUP Phenolic Scrap Support \$88.07



Chip Breaker

Chip Breakers

• For Pistorius Saws

A Chip Breaker is a block of phenolic resin that sits inside the fence of a miter saw and aids in cleanly cutting mouldings by filling any gap that may occur between the back edge of a moulding and the cutting fence. Chip Breakers are approximately 2" x 2 1/4" in size and range from 1/2" to 3/4" thick. They are held into the saw fence by two allen key bolts. Chip Breakers are wear items, and must be replaced regularly to ensure consistent clean cutting.

Item #	Description / Dimensions	Each
--------	--------------------------	------

CHPBKR Chip Breaker for MN200 • 2" x 2 1/4" x 1/2" \$15.70

CHPBKR14 Chip Breaker for 14" saw • 2" x 2 3/4" x 3/4" \$30.90



Hand Miter Cutter

Easily cuts balsa and bass wood strips up to 1/2" thick. Great tool for cutting spacers and plastic fillets. Cuts angles precisely from 45° to 120° with mitered 45° bevels. Cast aluminum angle plate with English and metric markings. Features built-in safety lock and no-slip rubber grips for a comfortable, textured hold. Carbon steel cutting blade.

Item #	Description	Each
--------	-------------	------

MITERCUT Hand Miter Cutter \$27.47

California Customers- WARNING: Cancer and Reproductive Harm - www.P65Warnings.ca.gov



Items with this symbol "Ride Along" with your length or chop moulding order at no extra delivery charge.



Hot Melt Glue Gun

Dual temperature glue guns are ideal for a wide range of framing projects. Featuring a high and low switch, you can use the high temperature setting for better bonding to heavier items such as metals, plastics and wood. Use low temperature for bonding delicate material such as lace, ribbon, foam and lightweight fabric. A great tool for composing 3-dimensional project mounting in shadowboxes. • 40 watts, 120 volts • Uses 7/16" diameter glue sticks.

Item #	Description	Each
GLGUN270	Dual Temperature Glue Gun	\$13.70



Item #	7/16" Diameter Glue Sticks:	Each
GLSTK20	All-purpose 4" glue sticks (20 per bag)	\$ 3.66
GLSTK50	All-purpose 4" glue sticks (50 per bag)	\$ 8.69
GLSTKF12	Fabric Stik 4" glue sticks (12 per bag)	\$ 2.74
GLSTKW12	Wood Stik 4" glue sticks (12 per bag)	\$ 2.74
GLSTKB12	High-Temp 4" glue sticks (12 per bag)	\$ 2.74



Attach-EZ® Mounting System

Attach-EZ® offers a line of products that will enable framers to easily mount almost all types of fabric & 3D work. Attach-EZ Mounting Systems have been called the framers best friend by framers around the world. The totally reversible methods and educational DVD (which is included in the kit) now allow labor intensive projects to be completed in a fraction of the time, while still maintaining archival quality standards.

Item #	Description	Each
 AZ4005C	Attach-EZ Starter Kit	\$161.69

 **ATTACH-EZ® Starter Kit** with 10" case & instructional DVD for fabric mounting only: 1 Fine Fabric Tool, 1 Micro Stitch Tool, 1200 Black & 1200 White Micro fasteners (4.4mm, 5.4mm, 6.4mm), 2 Micro needles, 3000 Fine Fabric Fasteners (3.5, 5, 7, 9, & 11 mm), 3 Fine Fabric standard needles & 2 short Fine Fabric needle for the 3.5 & 5 mm, written instructions, DVD and 10" Case.

Item #	Attach-EZ Product:	Each
AZ443WT	Micro-Tack Fasteners (Standard) 2400 ct.	\$17.77
AZ443BK	Black Micro-Tack Fasteners, 2400 ct.	\$17.77
AZ441-2	Micro-Tack Needles, 2-pack	\$25.77
AZ444-7	Fine Fabric Fasteners, 1/4" 2000 per bag	\$12.88
AZ444-7B	Fine Fabric Fasteners (Black), 1/4" 2000/bag	\$12.88
AZ442	Fine Fabric Fasteners, 1/2" 2000 per bag	\$12.88
AZ440-2	Fine Fabric Needles, 2-pack	\$13.32
AZ501	EZ-Tack Complete Kit	\$35.18
AZ433	Micro-Stich Hand Tool (Green)	\$34.66
AZ431	Fine Fabric Hand Tool (Mauve)	\$24.87



Self-Healing Cutting Mats

Five layers of PVC give these cutting surfaces maximum self-healing capability and prolonged life. Non-blunting surface material keeps cutting blades from becoming dull. Each mat contains inch and metric measurements and angle cuts on the top surface, as well as 1/2" gridlines, making them the perfect work surface for precision cutting. Either side can be used as a cutting surface. Small cuts made with sharp blades almost disappear. Do not use with utility knives, (i.e. cutting hard boards) as deep gouges will not heal. Cutting tools suited for paper such as Xacto style pen knife or razors are ideal.

Item 6171 - 24" x 36" Cutting Surface
Item 6169 - 40" x 60" Cutting Surface

Item #	Description	Each
6171	24" x 36" Self-Healing Cutting Mat	\$ 35.71
6169	40" x 60" Self-Healing Cutting Mat	\$327.48

ULTIMO II®

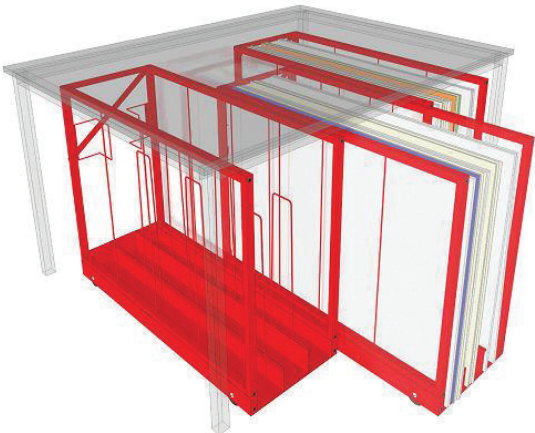

Ultimo II Foam & Matboard Storage Cart

Storing mountboard between dividers under a workbench is standard practice by many framers. But keeping those boards neat and tidy is a challenge, especially extracting smaller pieces which tend to get pushed to the back. The Ultimo II is a stable and free rolling cart with three mounting board storage slots. The light but rigid steel structure rolls under a workbench on four large wheels hidden inside the chassis. The board is kept upright by vertical dividers. Ultimo II carries up to 160 standard size foam boards, 44" x 32".



Ultimo II rolls on 4 large plastic wheels hidden in the chassis.

The Ultimo II can also be used to safely store mounted prints. It is not designed to store heavy materials such as glass or acrylic. The unit rolls under any bench with 34" or more clearance. It is carefully packed and comes complete with full instructions for assembly and usage.

• Dimensions 1206 x 855 x 375mm

Item #	Description	Each
3200	Ultimo II Storage Cart	\$310.29



Kraft Paper

All-purpose, strong and budget-friendly backing papers to seal the back of the frame to prevent the encroachment of dust and debris while transporting and for its life on the wall. Also used as a durable wrapping paper for finished projects or when storing or interleaving. Spooled to fit on all standard paper roll dispensers/cutters. Available in natural/brown and in black for a more refined look, and in 40 lb., 50 lb., and 70 lb. weight. Natural kraft made of strong virgin paper stock.

• 40 lb. Natural/Brown Kraft Paper Rolls **40**

Item #	Description	Each	3 or more	6 or more
KP1540	15" Natural Kraft • 40 lb.	\$ 21.30	\$ 19.17 ea.	\$ 18.10 ea.
1037B	18" Natural Kraft • 40 lb.	\$ 22.05	\$ 19.85 ea.	\$ 18.74 ea.
1037C	24" Natural Kraft • 40 lb.	\$ 28.82	\$ 27.14 ea.	\$ 25.47 ea.
1037E	30" Natural Kraft • 40 lb.	\$ 36.36	\$ 34.24 ea.	\$ 32.13 ea.
KP3640	36" Natural Kraft • 40 lb.	\$ 38.51	\$ 34.66 ea.	\$ 32.73 ea.
1037J	40" Natural Kraft • 40 lb.	\$ 53.98	\$ 50.85 ea.	\$ 47.69 ea.

• 70 lb. Natural/Brown Kraft Paper Rolls **70**

Item #	Description	Each	3 or more	6 or more
1037R	48" Natural Kraft • 70 lb.	\$ 57.80	\$ 54.45 ea.	\$ 51.08 ea.
1037S	60" Natural Kraft • 70 lb.	\$ 77.73	\$ 73.22 ea.	\$ 68.70 ea.

• 50 lb. Natural/Brown Kraft Paper Rolls **50**

Item #	Description	Each	3 or more	6 or more
1037D	24" Natural Kraft • 50 lb.	\$ 29.94	\$ 28.19 ea.	\$ 26.45 ea.
1037F	30" Natural Kraft • 50 lb.	\$ 40.61	\$ 38.24 ea.	\$ 35.89 ea.
KP3650	36" Natural Kraft • 50 lb.	\$ 38.51	\$ 34.66 ea.	\$ 32.73 ea.
KP4050	40" Natural Kraft • 50 lb.	\$ 43.07	\$ 38.77 ea.	\$ 36.61 ea.
KP4850	48" Natural Kraft • 50 lb.	\$ 57.30	\$ 51.57 ea.	\$ 48.70 ea.

• 50 lb. Black Kraft Paper Rolls **50**

Item #	Description	Each	3 or more	6 or more
KPB2450	24" Black Kraft • 50 lb.	\$ 50.39	\$ 45.35 ea.	\$ 42.82 ea.
4790B	30" Black Kraft • 50 lb.	\$ 75.80	\$ 71.44 ea.	\$ 60.64 ea.
KPB3650	36" Black Kraft • 50 lb.	\$ 71.04	\$ 63.95 ea.	\$ 60.39 ea.
KPB4850	48" Black Kraft • 50 lb.	\$ 106.28	\$ 95.66 ea.	\$ 90.34 ea.

Vertical Kraft Paper Dispensers

Floor standing vertical paper cutter that conveniently saves workspace due to its smaller footprint and as an alternative to table top dispensers. Vertical stand dispensers are especially helpful for storing and dispensing larger, heavy rolls. Easy drop-in loading. Base has sockets for adding wheels if desired.

Item #	Description	Each
KPD27V	Vertical Dispenser for 18" - 24" rolls	\$ 89.29
KPD36V	Vertical Dispenser for 30" - 36" rolls	\$ 104.73
KPD48V	Vertical Dispenser for 40" - 48" rolls	\$ 126.78



Mountable Kraft Dispensers **R**

Mountable kraft dispensers are a great alternative to standing and table models allowing you to mount to a table, wall or other vertical surface near your fitting or wrapping station. Strong all steel construction.

Item #	Description	Each
KPD36	Wall Mount Dispenser for 36" rolls	\$ 37.75
KPD40	Wall Mount Dispenser for 40" rolls	\$ 43.86

All-In-One Kraft Paper Dispensers **R**

All -One-Dispensers are designed to have dual purpose as a table-top kraft dispenser and paper cutter, and as a plastic bag dispenser for rolled bags. Durable and simple, these all-steel dispensers are a snap to set up - just unfold the base and set on the counter and you're ready to load kraft paper or plastic bag rolls.

Item #	Description	Each
KPD15A	All-In-One Dispenser for 15" rolls	\$ 18.29
KPD24A	All-In-One Dispenser for 24" rolls	\$ 19.12
KPD36A	All-In-One Dispenser for 36" rolls	\$ 25.84
KPD40A	All-In-One Dispenser for 40" rolls	\$ 29.26



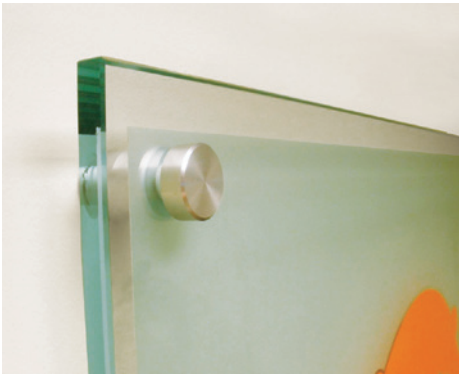

Standoff Hardware

Standoffs can be used to mount panels and is installed on a permanent surface to create a raised impression. These aluminum panel hardware can be used with acrylic, metal, glass, wood or any other materials. Installation of these sign mounts is easy and the cost is minimal. The aluminum standoffs can be used to clamp two clear panels together to create a poster sleeve. The panels can be easily removed, by unscrewing the standoff caps, anytime when changing the poster. These panel mounting hardware can be used to stack layers of graphic panels for an eye-catching effect. *Satin & polished*



Item #	Finish	Diameter	Length	1-39 pcs.	40+ Mixed
SOF1	Satin	3/4"	3/4"	\$ 7.55	\$ 6.87
SOF2	Satin	3/4"	1 3/4"	\$10.08	\$ 9.17
SOF3	Satin	3/4"	2 1/2"	\$13.86	\$12.60
SOF4	Satin	1"	1"	\$ 8.82	\$ 8.01
SOF5	Polished	3/4"	3/4"	\$ 7.55	\$ 6.87
SOF6	Polished	3/4"	1 3/4"	\$10.45	\$ 9.50
SOF7	Polished	3/4"	2 1/2"	\$15.38	\$13.98
SOF8	Polished	1"	1"	\$ 9.82	\$ 8.91



One-Handed Frame Clamp

Ratcheting band Clamp ideal for gluing picture frames, furniture, shelves and other workpieces. Self-adjusting corners to hold various angles. Quick-retract band, and an encasement for the band so that it is protected and won't twist. 16-feet of strap accommodates all common projects. Encased band is protected and won't twist.

Item # **SCL16** \$62.23 each



Print Holders

Ideal for displaying, storing and protecting artwork, documents, prints, posters, and much more. These ultra-light and super-strong sleeves are made from heavy-duty 10 mil rigid clear flexible vinyl with reinforced double stitched binding on all sides. The opening is on the short side. Includes a removable two-sided white acid-free cardboard insert for rigidity. Artwork may be inserted and displayed on both sides. 5 sizes 

Item #	Description	Each
5010AW	18" x 24" Print Holder	\$ 6.23
5010BW	20" x 26" Print Holder	\$ 6.35
5010CW	26" x 32" Print Holder	\$ 9.60
5010DW	30" x 40" Print Holder	\$10.09
5010EW	32" x 43" Print Holder	\$14.89



Print Display Rack

These rugged display bins are designed to hold up to 100 unframed prints, posters, or pieces of art. Use them in galleries, shows, and art fairs. They can display works measuring up to 32" x 40". Bins are constructed of welded, square, heavy gauge, one-inch steel tubing with powder electrostatic, scratch-resistant black paint. Locking casters provide a sturdy base for reviewing pieces on display.

Item #	Description	Each
493	Print Display Rack	\$264.88

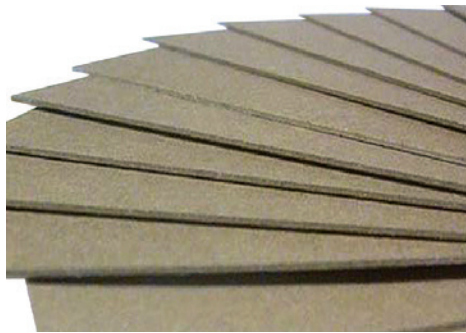

Bainbridge Newsboard

Newsboard is the most economical mounting board there is. Suited for use with inexpensive or temporary artwork and reinforcement backings on mirrors, signage, and display work. Ideal filler for non-conservation treatments.

Item 1069E - 2-ply (.040), **60** 32.5" x 41" sheets per box
 Item 1069F - 4-ply (.080), **30** 32.5" x 41" sheets per box

Item #	Description	1 Box	4 or more
1069E	2-ply Newsboard (.040)	\$149.31	\$135.45 ea.
1069F	4-ply Newsboard (.080)	\$167.90	\$148.05 ea.



Corrugated Cardboard Sheets

Doubled walled, 200-pound test, c-fluted corrugated cardboard sheets available by the sheet or in 25-sheet sets. A must-have for packaging and protecting finished work.

Available in 5 sizes:
 32" x 40", 36" x 48", 36" x 72", 40" x 64", & 48" x 96"

Item #	Size	1-24 sheets	25-49	50+ sheets
CB3240	32 x 40	\$ 1.54 ea.	\$ 1.45 ea.	\$ 1.27 ea.
CB3672	36 x 72	\$ 2.71 ea.	\$ 2.50 ea.	\$ 2.26 ea.
CB4064	40 x 64	\$ 2.76 ea.	\$ 2.56 ea.	\$ 2.28 ea.
CB4896	48 x 96	\$ 4.88 ea.	\$ 4.49 ea.	\$ 4.05 ea.

Item #	Size	1-49 sheets	50-99	100 sheets+
1041B	36 x 48	\$ 2.61 ea.	\$ 2.26 ea.	\$ 1.91 ea.

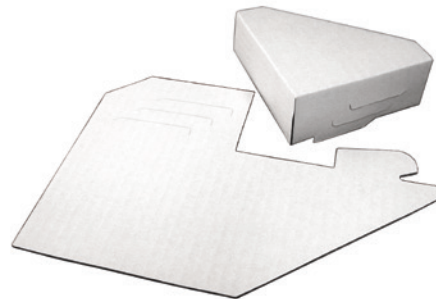

Cardboard Corner Protectors

Available in adjustable and fixed depth sizes, these sturdy 200 lb. test white cardboard corners are easy to assemble for a snug secure fit, protecting your finished projects while in storage or transit.

• Available in bulk 8,400 corner pallet! (Item 2065C)

Item #	Type/Depth (Qty/Box)	1 Box	3+Boxes
H220	Adjustable 1/2"- 1.5" (200)	\$ 21.00	
H221	Adjustable 2"- 2.5" (700)	\$138.21	
Item #	Type/Depth (Qty/Box)	1 Box	3+Boxes
H217	Adjustable 1/2"- 1.5" (1000)	\$ 79.75	\$ 70.98 ea.
H218	3/4" fixed size corner (1000)	\$110.76	\$ 98.49 ea.
H219	1" fixed size corner (1000)	\$ 142.83	\$127.11 ea.

Item #	Description	Per Pallet
2065C	8400 ct. Bulk Pallet-Adjustable Corners Adjustable 1/2"- 1.5" (not eligible for Ride Along program)	\$632.12



Bubble Bags

Give your more delicate projects an extra amount of protection with Bubble Bags.

Item #	Description	1 Box	3 + Boxes
8362	50 ct. 21x26 Bubble Bags	\$237.06	\$204.66 ea.
8364	30 ct. 26x36 Bubble Bags	\$260.53	\$205.53 ea.
8366	25 ct. 33x43 Bubble Bags	\$320.22	\$247.72 ea.



Bubble Corner Pads

Protect frame corners with an extra layer of padding with bubble corners. Works great in tandem with cardboard corner protectors or alone. Also used for protecting readymade stock frames and for delicate finish frames before adding cardboard corners. Small, Medium, & Large

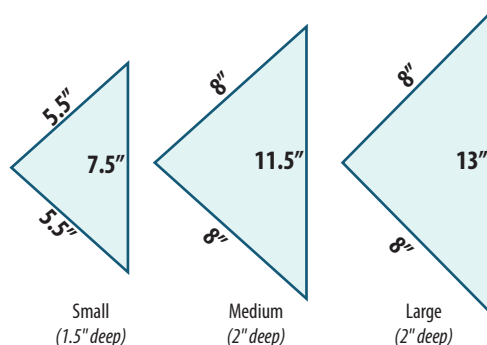

Item #	Description	1 Box	3 + Boxes
8350	2250 ct. Small Corners	\$344.02	\$289.93 ea.
8352	1000 ct. Medium Corners	\$255.09	\$215.81 ea.
8354	800 ct. Large Corners	\$266.33	\$223.14 ea.



Plastic Bags • by the Roll

Clear, 2 millimeter thick plastic bags are rolled and perforated for easy dispensing. Great for wrapping and protecting finished work in your frameshop as well as protecting delicate materials & inventory such as mat scraps, fabrics, etc. Available in 11 sizes.

Need a dispenser for your Plastic Bags?
 See our All-in-One Dispensers on Page 46

We maintain the highest bag per roll count for the lowest price per bag!

Item #	Size	Bags/Roll	1-4 Rolls	5-9 Rolls	10+Rolls
5005A	14 x 17	500	\$40.99 ea.	\$36.39 ea.	\$35.25 ea.
5005B	18 x 21	500	\$54.77 ea.	\$48.64 ea.	\$47.10 ea.
5005C	21 x 26	500	\$71.20 ea.	\$63.22 ea.	\$61.23 ea.
5005D	26 x 36	200	\$65.05 ea.	\$57.75 ea.	\$55.93 ea.
5005E	34 x 44	200	\$98.12 ea.	\$87.12 ea.	\$84.37 ea.
5005G	48 x 64	100	\$102.88 ea.	\$91.34 ea.	\$88.45 ea.

Item #	Size	Bags/Roll	1-4 Rolls	5-9 Rolls
H222	21 x 25	300	\$43.62 ea.	\$41.43 ea.
H223	25 x 35	180	\$43.62 ea.	\$41.43 ea.
H224	35 x 44	100	\$43.62 ea.	\$41.43 ea.
H225	36 x 48	90	\$43.62 ea.	\$41.43 ea.
H226	44 x 64	55	\$43.62 ea.	\$41.43 ea.





Bubble Wrap • by the Roll

250' and 500' rolls of high quality bubble wrap, perforated every 12" for easy tear & wrap functionality. Available in 1.25" large bubble, and 3/8" small bubble in either 24" or 48" wide rolls.

Item #	Description	1 Roll	4 + Rolls
PM100	24" Large Bubble, 250'	\$ 41.87	\$ 37.68 ea.
PM102	24" Small Bubble, 500'	\$ 69.98	\$ 62.99 ea.
PM101	48" Large Bubble, 250'	\$ 83.80	\$ 75.42 ea.
PM103	48" Small Bubble, 500'	\$ 140.02	\$ 126.02 ea.



Foam Padding • by the Roll

750' of soft lightweight 3/32" polyfoam available in 12", 24", and 36" wide rolls.

Item #	Description	1 Roll	2 + Rolls
PM108	12" - 750' polyfoam roll	\$ 53.83	\$ 48.46 ea.
PM107	24" - 750' polyfoam roll	\$ 107.68	\$ 96.93 ea.
PM106	36" - 750' polyfoam roll	\$ 189.19	\$ 170.27 ea.

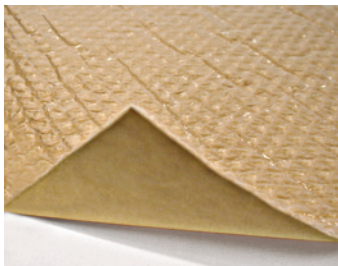

Bubble with Kraft Backer

Convenient all-in-one kraft paper with bubble wrap padding, used to quickly make folded corner protectors for frames.
6" x 250 ft. roll

Item #	Description	1 Roll	6 + Rolls
PM109	6" - 250' roll	\$ 16.80	\$ 15.13 ea.



Stretch Wrap

80-gauge stretch film in a 16" wide roll, perfect for wrapping and binding large quantities of items when packaging for transport. Great for grouping items on pallets, consolidating boxes, and securing finished framing projects for delivery.
Hand dispensible 1,500 ft. roll

Item #	Description	1 Roll	4+ Rolls
PM105	16" x 1500' stretch roll	\$ 18.91	\$ 17.01 ea.



Stretch Wrap • 5" Wand

Handy wand of 5" stretch wrap allows quick work of wrapping items for packaging. Each wand holds 1000 feet of 80-gauge stretch wrap.

Item #	Description	1 Roll	12+ Rolls
PM104	5" x 1000' stretch roll	\$ 6.81	\$ 5.69 ea.



Shrink Wrap Film • Center Folded

Acid-free center-folded clear polyvinyl shrink plastic for use with manual or automated shrink wrapping machines. Will not discolor or emit harmful gasses.
75-gauge, 500 ft. rolls

Item #	Description	1 Roll	3+ Rolls
2110	24" 75-gauge roll, 500'	\$ 79.32	\$ 73.92 ea.
2111	28" 75-gauge roll, 500'	\$ 92.56	\$ 86.26 ea.
2112	32" 75-gauge roll, 500'	\$ 104.60	\$ 97.49 ea.
2113	36" 75-gauge roll, 500'	\$ 119.04	\$ 110.95 ea.

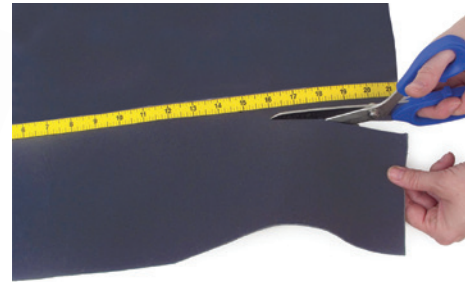

Loop Fabric

Designed for engagement with VELCRO® type hook fasteners. Made of 100% nylon fabric that you can apply to boards, walls, and other substrates for shop displays, portfolios, etc.
Sold by the yard. Available in gray or black.

Item #	Fabric size/Description	1 yard	50+ yds.
4240	60" wide Gray loop fabric	\$ 18.62	\$ 16.14 ea.
4242	60" wide Black loop fabric	\$ 18.62	\$ 16.14 ea.

Item #	Fabric size/Description	1 yard	30 yds.
4244	54" wide Black w/PSA Backer	\$ 55.80	\$ 48.35 ea.

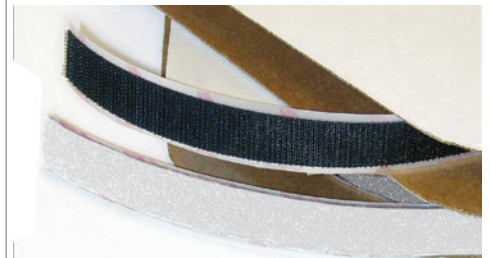

Adhesive Hook & Loop

Velcro type hook & loop fabric backed with high-tack pressure-sensitive adhesive. 1" wide
Available in 25 yd. rolls or by the yard (3 yard minimum).

Item #	Description	1 yd.	10+ yds.	25yd. roll-per yd.
4232H	Hook - Black	\$ 1.89	\$ 1.25 ea.	\$ 1.03 ea.
4232L	Loop - Black	\$ 1.89	\$ 1.25 ea.	\$ 1.03 ea.
4230H	Hook - White	\$ 1.89	\$ 1.25 ea.	\$ 1.03 ea.
4230L	Loop - White	\$ 1.89	\$ 1.25 ea.	\$ 1.03 ea.

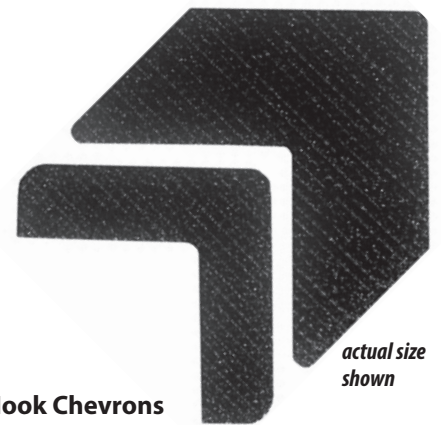

Hook Chevrons

Self-adhesive VELCRO® type hook fasteners ideal for attaching to corner samples or signage. Made of 100% nylon fabric that you can apply to covered walls, loop fabric, etc. Strong adhesive sticks to wood and maintains adhesion for years.

Large: 3/4" x 1 3/4" chevron
Small: 3/8" x 1 3/4" chevron

Item #	Size • Qty. Per Roll	Each
SMCHV	Small Chevrons • 1500 per roll	\$ 42.99
LGCHV	Large Chevrons • 900 per roll	\$ 42.99

★ See omegamoulding.com for pricing



79170

Box Qty: 150 ft.

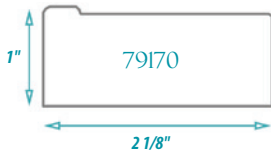

79169

Box Qty: 360 ft.

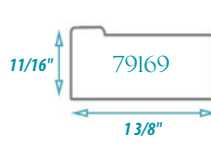

gallery wrap stretcher



80382

Box Qty: 115 ft.

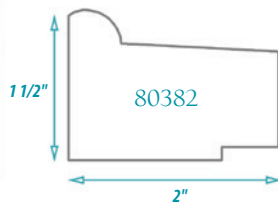

83890

Box Qty: 220 ft.

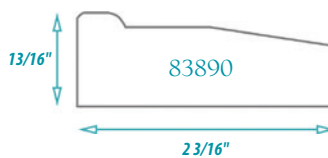

83394

Box Qty: 210 ft.

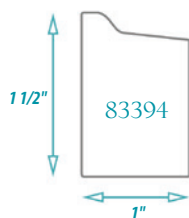

83802

Box Qty: 440 ft.

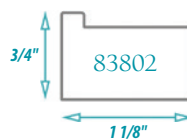

Dual-Height Stretcher • Large

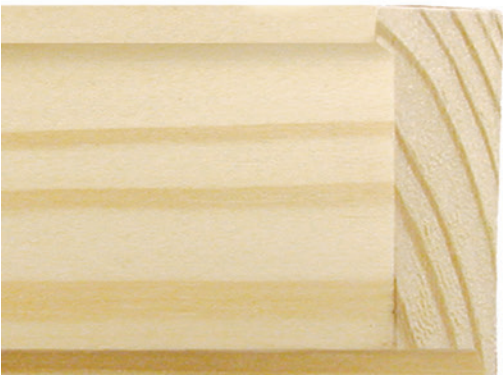

83395

Box Qty: 115 ft.

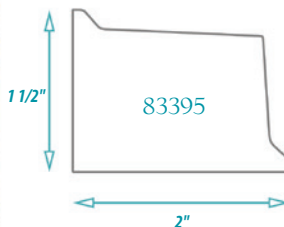

Dual-Height Stretcher • Small



83393

Box Qty: 300 ft.

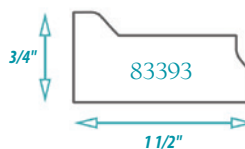

 All Educational Media items are Ride-Along eligible



Picture Framing

Cutting, joining, moulding, glazing, measuring, mats, mounting equipment, frame design, working with canvas, conservation.

• **Item B116** \$25.20

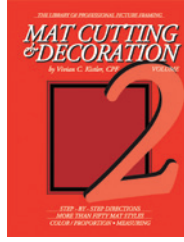

Mat Cutting & Decoration

50+ mat cuts, V-grooves, French mats fabric wrapping, multi-openings, circles, ovals, gothic arches, and other specialty cuts.

• **Item B019** \$25.20



Framing Needlework

Blocking, stretching, cleaning, crewel, needlepoint, cross-stich, antique samplers scarves, flags, and more.

• **Item B027** \$25.20



Conservation Framing

Art on paper, glazing, hinges, adhesives, boards, encapsulation, deacidification, framing fine art & heirlooms.

• **Item B035** \$25.20

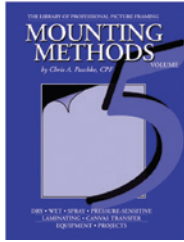

Mounting Methods

Drymounting, wet mounting, spray adhesives, boards, equipment, laminating, canvas transfer.

• **Item B043** \$25.20



Framing Photography

Mounting & framing multiple types of photographic media, finishes, & papers. Creative projects involving portraiture.

• **Item B051** \$25.20

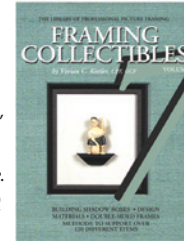

Framing Collectibles

Building shadow-boxes, double-sided frames, hinged boxes, and other creative projects for 3-dimensional objects and keepsakes.

• **Item B299** \$25.20



Cutting, Carving & Decorating Mats

How-to's on multi-angles, V-grooves, inlays, color panels, and unique mat carving techniques. Author Brian Wolf's favorite tips & tricks included with traceable patterns.

• **Item B85X** \$25.20

Where is Mrs. Smith's Watercolor?

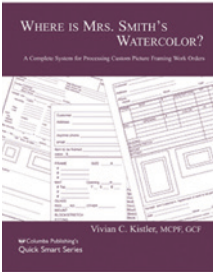

Have you ever had to search for a customer's framed piece? Avoid this unprofessional and embarrassing moment. This book will help you understand and establish a process for your framing jobs that will not only help your shop be more productive, but will reflect the professionalism that your customers expect. The efficient workflow of a frame shop is essential to success.

• **Item B06X** \$15.75

Who's the Boss?



Get the answers to common problems with employment. How to set up a training program for framers, frame counter salespeople and gallery salespeople. Setting the standards and company policy regarding: image of the company, framing methods, safety practices, operating equipment, waste, attitudes, product knowledge, selling procedures and customer complaints.

• **Item B221** \$15.75

Floorplans for Galleries & Frame Shops

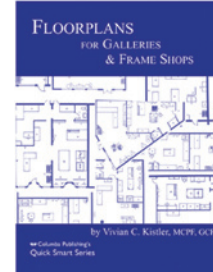

Nineteen floorplans for working shops are illustrated in this book. The assortment of shops includes galleries, frame shops, frame shops with galleries and galleries that offer framing. Included are illustrations of worktables and storage units for art, moulding, matboards, and supplies. Grid enclosed to begin your own shop layout.

• **Item B272** \$15.75

Starting a Picture Framing Business

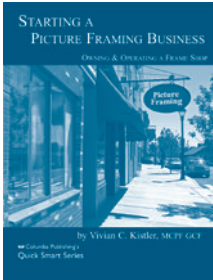

Valuable advice and insight on entering the marketplace. Topics include: Types of Shops, & Ways to Start a Frame Shop. Business Matters includes Business Entity, Lawyers, CPA, Bankers, Bookkeeping & Accounting, Financial Statements, Purchasing, Business Plan, and start up costs. Tips for choosing shop locations, hiring employees, and much, much more.

• **Item VK760** \$15.75

Add Framing To Your Photo Business

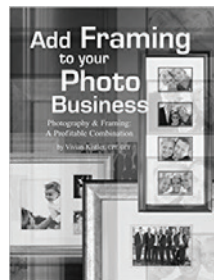

Step-by-step instructions! Benefit from the customer you already have and offer them a service they will surely need. Photography and picture framing are a profitable combination. Frames & Moulding, Glazing, Mat Designs, Matboards, Supplies, Equipment, Mat Cutting, Mounting, Fitting, Pricing, Processing explained.

• **Item B582** \$15.75

Add Picture Framing To Your Business

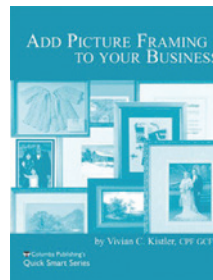

Framing can complement many art and design-oriented businesses. There are many levels of picture framing service from simple ready-made frames to complete custom framing. This book explains the five methods of offering this service as well as how the business of framing operates. Basic techniques, equipment, space requirements, pricing and a processing system are explained.

• **Item B477** \$15.75

Decorative Accessories Made From Moulding



Ever wonder what to do with all those pieces of scrap moulding? Learn how to transform them into imaginative creations! What to make, how to measure, cutting, building, lining, finishing tips. Step-by-step instructions.

• **Item B604** \$16.80

Event Planning & Marketing for Frame Shops

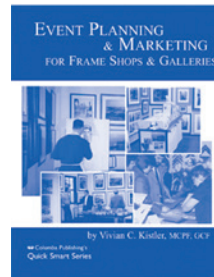

No shop is too small to hold an event! Traditional gallery show, charity benefit, or celebration of your years in business: whatever the occasion, an event in your shop creates excitement and gives you a great opportunity to attract customers and make sales. This book guides you through the entire process from advertising to running the event, to building relationship.

• **Item B574** \$15.75

Selling At the Framing Counter

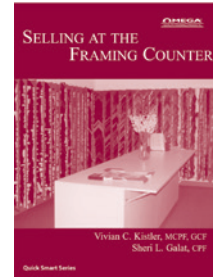

Custom Picture Framing is a true Service Industry-one of very few available today to the average person. Selling picture framing requires a level of helpfulness and knowledge rarely seen in today's marketplace, and a one-of-a-kind product. Specialty retail shops survive because they offer something different from mass market stores. It is not just providing a product, it is a relationship.

• **Item B-353** \$15.75

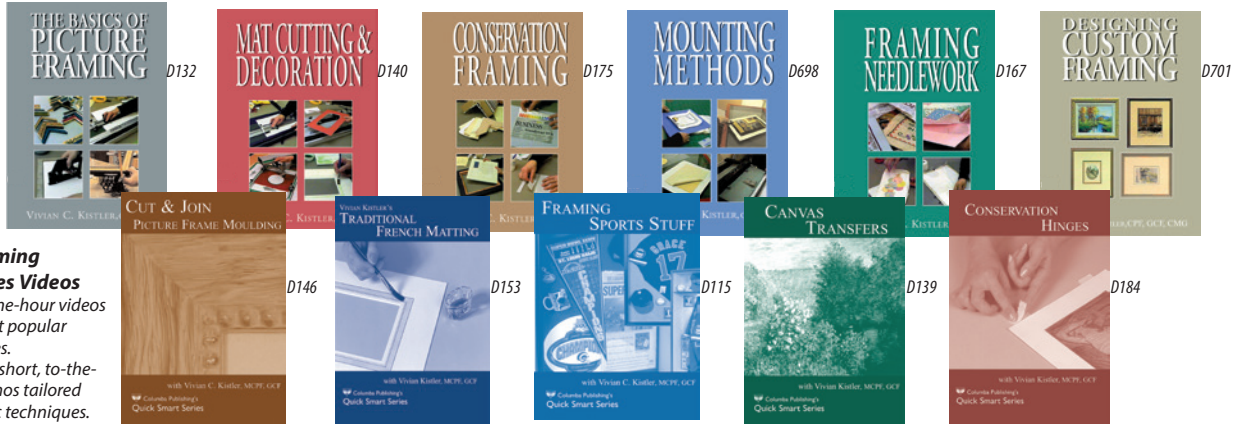

Vivian Kistler's Framing & Quick Smart Series Videos
Instructional framing one-hour videos demonstrating the most popular methods and techniques. Quick Smart videos are short, to-the-point 15-30 minute demos tailored toward learning specific techniques.

• Framing Instruction Videos

Item #	Description	Video Download
D132	Basics of Picture Framing	\$31.50
D140	Mat Cutting & Decoration	\$31.50
D175	Conservation Framing	\$31.50
D698	Mounting Methods	\$31.50
D167	Framing Needlework	\$31.50
D701	Designing Custom Framing	\$31.50

• Quick Smart Series Videos

Item #	Description	Video Download
D146	Cut & Join Moulding	\$21.00
D153	Traditional French Matting	\$15.75
D115	Framing Sports Collectibles	\$21.00
D139	Canvas Transfers	\$15.75
D184	Conservation Hinges	\$31.50

Measuring Made Easy

Tackles the basics of how to measure for creating picture framing projects.

• Item D981 \$15.75

Cutting & Installing Fillets

How to measure & cut fillets to properly fit into your cut mats.

• Item D566 \$21.00



Achieve Professional Results with a Master Class in Digital Printing

The Perfect Print is a professional level workshop series of 5 DVDs by master printer Randy Hufford (M. Photography, CR, PPA Certified). From Photoshop techniques that will get your images to stand out, including finishing, stretching, framing, and selling. These methods will showcase your work as a true piece of art, as well as give you the edge when outputting prints for your customers.

Calibration

This DVD makes Soft Proofing easy to understand with simple steps you can follow to maximize your workflow production. Soft Proofing is the system used to see on the computer monitor what the actual print will look like before printing.

• Item D101 \$72.45

Ink & Media

In this DVD you will be given insight into which medias you should use based on your application. Packed with valuable information about a variety of medias, inks, ICC printer profiles, an overview of printer technologies, advantages of a software RIP, and much much more.

• Item D102 \$72.45

Digital Art Enhancements

Learn how to get your images prepared and looking their best before you print them. You will be shown simple techniques in both Photoshop and Lightroom, which will make the output from your customers digital files better than you have ever seen before.

• Item D103 \$72.45

Finishing Techniques

In this DVD, you will be introduced to different finishing techniques for working with Canvas and Fine Art Medias, from coating your prints to embellishing them and to increase your profits by providing properly finished & beautiful works of art.

• Item D104 \$72.45

Marketing Giclée

Randy shares his experiences and insights on how to succeed with good marketing and increase your exposure and sales of Fine Art Prints and Digital Printing services. Who can benefit from these techniques? Anyone in the Art and Framing industry!

• Item D105 \$72.45

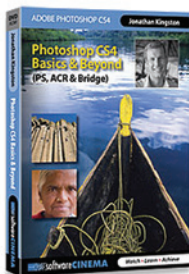

Photoshop CS4 Basics & Beyond

Learn Photoshop CS4 from the ground up with a professional photographer's perspective. Perfect for beginners to pros who need an in-depth knowledge of CS4. Learn methods for taking your photographs from processing to printing with control and predictability using Photoshop. Instructed by Jonathan Kingston

• Item D106 \$72.45

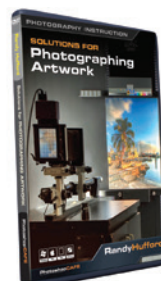

Solutions for Photographing Artwork

Correctly reproducing the exact color and texture of a painting in a photograph has always been a challenge. Ideal for artists, framers, gallery owners, this essential collection of tutorials teaches photographers how to accurately photograph 2 dimensional artwork for replication.

• DVD ROM
• Item D100 \$72.45



Tensador II Canvas Stretching Machines

Tensador II is a pneumatic machine designed to stretch canvas using a unique clamping mechanism. It firmly grips canvas without piercing or tearing and assures proper tension without ripples or over stretching. Comes with foot operated adjustable safety pedal, air filter, and air regulator and requires no electricity. Tensador II can be used with dedicated silent air compressors or shop dedicated air lines. Stretches canvas from 8" x 8" through 48" x 48" (T-125) or 60" x 60" (T-155).

The unique gallery wrap on the Tensador II provides access to the back side of the stretcher bar. This operation requires use of a long nose staple gun (see pages 25-26) to reach the back side of the bar. Gallery wrap or stapling on the back side of the stretcher requires 1 1/2" for canvas past the back side of the stretcher bar to staple on the side 3/8" is required. Each model can accommodate most any commercial stretcher bar size from 1/2" - 2 1/2" thick. The canvas image area is visible during stretching operation to ensure proper location of image.

Necessary adjustments can be made for canvas size changes resulting in fast production when stretching multiple size images or bar sizes. The machines small footprint makes for easy storage or permanent placement within your frame shop or production house. Can stretch up to 20-30 canvases per hour.

Item #	Description	Each
4137	T-125 48" Tensador II Canvas Stretcher & Gallery Wrap Machine	\$3224
4137A	T-155 60" Tensador II Canvas Stretcher & Gallery Wrap Machine	\$3831



C+H Thumbnail Master

The C+H Thumbnail Master is the industry's leader in thumbnail routers, lending versatility in frame joinery for small and large framing businesses alike. The Thumbnail Master provides routing of thumbnail channels at 6 depth capabilities, all easily set on an easy-to-read dial. Allows thumbnailing mouldings up to 1 7/8" deep and has a versatile clamping height which can hold mouldings from 1/2" to 3 3/4" tall. Easy grip guide handle and ratcheted bit handle for simple adjustment of the routing bit.

For Thumbnail inserts, see Page 22

Item #	Description	Each
5050B	C+H Thumbnail Master	\$1255



Router Bits for C+H Thumbnailer

Steel and carbide replacement bits for the C+H Thumbnail Master router. 

Item #	Description	Each
5054	Steel Replacement Bit	\$ 25.35
5054C	Carbide Replacement Bit	\$ 44.05



EXP42 Plus Laminator

The EXP 42 Plus Laminator is a heavy duty, industrial strength wide format laminating machine. It features variable speed, heated rollers, and can be mounted on a stand (optional) or table. Mounts and laminates printed material in a few simple steps, and is very easy to maintain. A perfect fit for galleries, frame shops, and digital print shops.

- Working Width: 41"
- Width: 57"
- Height: 19 1/4"
- Depth (with feed tray): 27 1/2"
- Net Weight (Minus Stand): 205 lbs.
- Shipping Weight: 420 lbs.
- Speed: 0 - 10 fpm
- Maximum Temperature: 300°F
- Maximum Aperture: 1/2"
- Roller Diameter: 3"
- Electrical Requirements: 230V 30A
- Footswitch: (optional)
- Release Liner Rewind: (optional)
- Slitter Kit: (optional)

Item #	Description	Each
6190	42" EXP Plus Laminator	\$8706



Traco 40" Shrink Wrap Machine

The Traco SS-40DS Deluxe SuperSealer Shrink Wrap System is perfect for any project that needs sealing. Portable, lightweight and sleek, the Deluxe Super-Sealer is built to last. The Super-Sealer cuts and seals film automatically, no need to tear your package away. It uses any type or gauge of film. Comes with an adjustable LED timer, maintenance kit and a lightweight adjustable temperature heat gun. No assembly required, just plug in and start packaging. Kit includes starter roll of film.

• Uses Item#s 2110-2113, Shrink films on Page 49

Item #	Description	Each
9200	Traco 40" Shrink Wrapper	\$599.59



Drytac Hot/Cold Vacuum Press

Ranging from photographs, to delicate graphics, digital prints, and posters, as well as for mounting overlay laminates, canvas transfers, and fabric mats, this vacuum press is a well proven, highly technological product that features a clear tempered glass top that contain heating elements. The glass surface distributes heat evenly to provide a stable mounting temperature and allows the user to view the mounting process to avoid mistakes. The glass top platen quickly reaches the desired temperature and maintains an accurate temperature within 5 degrees (depending on opening and closing). Unit features digital controls, programmable heat & time settings, LCD readouts, manual override switch, and a resettable circuit breaker. Comes complete with 110 volt vacuum pump. Requires 220 volt hook up (plug included). Made in the USA.



Item #	Description	Each
1401	36" x 48" Drytac Glass Top Vacuum Hot/Cold Press	\$ Call for Pricing
1400	44" x 68" Drytac Glass Top Vacuum Hot/Cold Press	\$ Call for Pricing

Item #	Description	Each
1408	Floor Stand for 36" x 48" Drytac Press	\$ Call for Pricing
1409	Floor Stand for 44" x 68" Drytac Press	\$ Call for Pricing



D&K Hot/Cold Vacuum Press

The D&K® Hot/Cold Vacuum Press is the preferred choice among professionals for dry mounting and laminating photos, artwork and posters. Microprocessor technology and touch-pad controls assure efficient, easy and reliable operation. Two available models range in working capacities of 44"x 68" (4468H), and 48" x 96" (5298H). Features a programmable systems controller that allows the user to select from six factory set programs, or easily preset your own combination. Features a maintenance-free vacuum pump, Dura-Box alloy frame with tight vacuum seal, end-of-cycle signal, and easy to read digital display. Unique bladder system permits mounting of materials of different thicknesses in a single cycle. Excellent for hot or cold, wet or dry mounting, laminating, applying textures, etc. Floor stand sold separately. 230 volt power required. Made in the USA.



Item #	Description	Each
4468H	44" x 68" Hot/Cold Vacuum Press	\$ Call for Pricing
5298H	48" x 96" Hot/Cold Vacuum Press	\$ Call for Pricing

Item #	Description	Each
4468STND	Floor Stand for 44" x 68" Vacuum Press	\$ Call for Pricing

D&K 550 Heat Mount Press

The D&K® 550 mechanical heat mount press is the versatile and dependable choice of framing professionals for the creative mounting and laminating of photos, artwork and posters, among other materials. This is the original soft-bed dry mounting/laminating press with adjustable 150-300 degree temperature control. Working area is 26 x 34 inches and press can complete larger jobs by working one area at a time. Pressure adjusts to fit materials up to 1" thick. The D&K 550, was previously known as Bienfang 550 & Seal model 500T-X. Includes built-in electronic temperature control with digital display and touchpad controls. Six pre-set programs for efficient operation, or set your own desired time & temperature. Operates on 120 volts. Made in the USA.



Item #	Description	Each
550	D&K 550 Mechanical Heat Press	\$ Call for Pricing

California Customers- WARNING: Cancer and Reproductive Harm - www.P65Warnings.ca.gov



Items with this symbol "Ride Along" with your length or chop moulding order at no extra delivery charge.



IM-30 Rotating Miter Saws

IM-30 PLUS

The IM-30 family of economical saws come pre-assembled from the factory. Designed to meet your needs for cutting wood, plastic and aluminum profiles with precision quality and productivity with the proper blade, the IM-30 can be designed with the options you require. Easy movement from +45° to the -45° by using the quick rotation handle of the saw head, it is possible to turn off the Lubricant Sprayer when cutting wood and plastic profiles. Cuts to 4" wide x 2 7/8" high. The IM-30 saws have a cast aluminum structure. The blade is on the axle of the motor improving rigidity for an accurate cut.



Model IM-30 Plus

Information & Features of the IM-30 PLUS

- Includes right and left calibrated scale, cabinet base with incorporated and independent dust collector unit, moulding stop to allow repetition of cuts sizes, pneumatic clamping system, lubricant fluid sprayer.
- Pneumatic clamping system to secure the profile to be cut, improving safety to operator. Air source required as this feature is operated pneumatically.
- Pneumatic lubricant fluid sprayer to lubricate and cool the metal and the blade while making the cuts, offering perfect finishing and greater durability to the blade.
- Please note: For optimum performance this machine is wired for 220v. You can have an electrician reconfigure it to be 110v.
- Self-locking device with heavy-duty conical pin with precision lock positions for the most used angles 0°, 10°, 15°, 22.5°, 30°, 45°.
- Quick adjust rotation feature, for easy movement of the blade.
- Calibrated scale to make accurate measurements to 47" long.
- Powder coated paint provides for a durable finish for the life of the saw.
- Please note that the blade is not included with this equipment; choose the proper blade for each type of material.

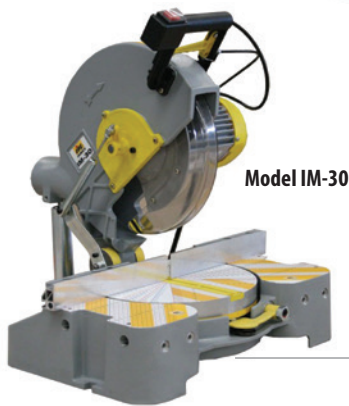

Model IM-30

IM-30 Models Available:

Please note: For optimum performance the following IM-30 models are wired for 220v. You can have an electrician reconfigure it to be 110v.

IM-30 – Basic single miter saw without blade.

IM-30MP – Includes cabinet base with incorporated dust collector, right and left table extension with calibrated scale, sliding moulding stop, and automatic clamping system to hold moulding in place when cutting.

IM30PLUS – Includes cabinet base with incorporated dust collector, right and left table extension with calibrated scale, sliding moulding stop, automatic clamping system to hold moulding in place when cutting, plus pneumatic lubricator for cutting aluminum.

IM-30AL – (*Special Order*) Includes cabinet (without dust collector), right and left measuring scale, sliding moulding stop, and fluid lubricant sprayer to cut aluminum moulding.

Miter Disc Sander

With this tool, you can accurately true a corner by simply rotating the 12" sanding disc against the miter cut. This allows for perfect corners when joining and therefore aids in producing a quality frame every time. Comes with a 45 degree template for accurate setting, Allen wrenches, a cleaning stick, and 3 sanding disks. Attaches easily to strong level work table.

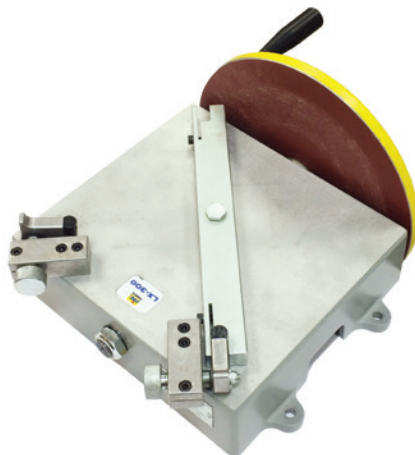

Item #	Description	Each
6585	Miter Disc Sander	\$404.25



3M Miter Sanding Discs

This 12-Inch diameter 100 grit aluminum oxide sanding disc is sized to fit most common disc sanders and is sold in a 3 pack. This sanding disc is pre-applied with pressure sensitive adhesive.

Item #	Description	Each
6585R	Replacement Sanding Discs	\$22.67

For Pricing & Information on miter saws & equipment, call Omega today at 1-800-289-6634



IM-300 Double Miter Saws

IM-300P Double Miter Saw • For Mouldings up to 3 3/16" wide

The IM-300 family of double miter saws have been developed by Inmes for cutting with absolute precision giving a perfect square corner joint. By choosing the proper blade and accessories the operator may cut raw, finished wood, plastic and aluminum. The IM-300P cuts miters with maximum dimensions of 3-3/16" wide by 3-3/16" height, with simultaneous action of the blades, which enables high production. Ships complete with blades, measuring scales, and built-in dust collector.

Information & Features of the IM-300P

- 2 - 1 1/2 hp. 220 volt single phase 3400 rpm induction motors (three phase available).
- The IM-300 P can be equipped with a wide range of accessories on demand.
- Uses 12" blades, 1" bore for cutting. 1 set (2 blades) is included.
- Front access through panel, making it quick to change the blades.
- Safety switch on front panel. Blades will not operate if open.
- Simultaneous action of the blades through a pneumatic foot pedal.
- Ample view of internal work area with illumination.
- Adjustable speed of blades descent.
- Pivot mechanism with conical bearings on cutting arms for greater precision and durability.
- Right Side Calibrated scale 58" long included. Optional 58" left side calibrated scale and 39" additional right scale also available.
- Moulding stop for setting lengths of cuts and repetitive cuts.
- High powered Dust collector with 3/4 hp 220 volt single phase motor and exhaust filter.
- Powder coated paint for a long lasting durable finish.
- Weight 616 lbs.
- Shipping dimensions 31" x 51" x 59" tall.

- **Item# 300PL39R** · Additional 39" Right Extension
- **Item# 300PL58L** · Additional 58" Left Extension



Model IM-300P

IM-300PL Double Miter Saw • For Mouldings up to 5 5/8" wide

The IM-300PL double miter saw was developed by Inmes to meet the growing demand of equipment and provide best quality cuts on several kinds of material. By choosing the proper blade you may cut raw, finished wood, plastic and aluminum profiles. The IM-300PL is a very robust machine making it possible to obtain high quality cuts. In one single piece of equipment you can get Quality, Safety, Design, and the best-cost benefit/ratio. Table height: 35.4", Bse: 48" x 26". Weight: 495 lbs.

The IM-300PL has the features of the above IM-300P but is capable of cutting up to 5 5/8" wide by 3 3/16 tall moulding. The blades operate in sequence, individually moving one at a time to allow this extra capacity. Pneumatic hold downs included to secure moulding for better cut quality and operator safety. Requires compressed air. Shipping weight: 730 lbs.



Model IM-300PL



Sprayway Saw Cleaner

Spray to quickly clean away pitch and gum from saws, router bits, and shape cutters. Safe to use on carbide, high speed steel, stainless steel, and cast iron surfaces. Works in just minutes!
18 oz. can

Item #	Description	Each
SP836	Sprayway 836 Saw Cleaner	\$ 7.70



ProVizGard Safety Glasses

Polycarbonate temples and single-piece wrap-around lens provide superior protection. Special lens coating for superior scratch resistance. Adjustable temples for a safe and perfect fit.
ANSI Z87.1-2003 standard certified

Item #	Description	Each	Box of 12
SGP43MB	ProVizGard Safety Glasses	\$5.47	\$4.94 ea.

 California Customers- WARNING: Cancer and Reproductive Harm - www.P65Warnings.ca.gov

For Pricing & Information on miter saws & equipment, call Omega today at 1-800-289-6634



Model IM-350P



Equipped with right & left arm
(Optional right arm extension available)



Model IM-350M

IM-350P Double Miter Saw • For Mouldings up to 8" wide

The IM-350P has been developed by Inmes for cutting with absolute precision to give a perfect square corner join for picture, photo framing and woodworking applications such as windows, doors and furniture components. By choosing the proper blade the operator may cut raw, finished wood and plastic moulding profiles. The large cutting capacity enables miter cuts up to 210mm (8") in width by 100mm (4") in height. The two saw blades are fixed at 45-degree angles and the blades are moved independently by a pneumatic control system.

Information & Features of the IM-350P

- Included with the equipment is a 14" set of saw blades for cutting.
- 2 HP high resistance induction motors 220 volt single phase.
- Access through the front panel makes for a safe, easy change of the saw blades. A safety switch prevents blade rotation.
- Heavy duty pivot mechanism with bearings on cutting arms.
- Calibrated 50" arms for each side (right and left) are included. An optional 39" right arm extension is available.
- Moulding stop for accurate setting of the length of cuts.
- Powder-coated paint provides a durable finish for the life of the equipment.
- The IM-350P comes with a drawer located inside that holds dust and waste materials. You may order the IM-350P with an optional chute that discharges the dust and waste materials out of the rear of machine.
- During the cutting process the moulding cannot move as it is firmly held to the work table by a horizontal clamping system that is activated by manually pulling handles forward.
- Adjustable speed of blades descent.
- Requires compressed air fitted with filter lube regulator.
- Unit dimensions with right 50" scale 59" x 33" x 108" wide
- Shipping weight 932 lbs.

IM-350M Double Miter Saw • Manual version of IM-350P

The IM-350M Double miter saw was developed with most of the features of the IM-350P. The main difference is that the 2 - 14" carbide blades are moved horizontally and independently by a manual control system. It offers miters with 8" wide by 4" height, with independent action of the blades.

- Vertical clamps to secure the profile in place during cutting.
- Right and Left calibrated 50" scale.

For Pricing & Information on miter saws, call Omega today at 1-800-289-6634

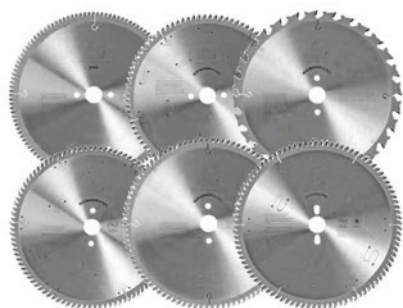

Inmes Saw Blades • With Nano-Grain Carbide tips that stay sharper longer!

SBHW96T • (for IM30) 12" 96-tooth, 30mm Bore (Wood only) saw blade with Nano-Grain Carbide teeth configured with an alternate bevel. Designed for superior cutting on hardwood mouldings. • **\$187.95 each**

SBWG90T • (for IM300P/PL) 12" 90-tooth, 25mm Bore (Wood & Gesso) saw blade with Nano-Grain Carbide teeth configured with a 4:1 alternate bevel. Designed for superior cutting on wood and gesso mouldings. • **\$161.40 each**

SBWD100T • (for IM350M/P) 14" 100-tooth, 30mm Bore (Wood only) saw blade with Nano-Grain Carbide teeth configured with a 4:1 alternate bevel. Designed for superior cutting on wood mouldings. Great for gesso coated profiles. • **\$242.43 each**

SB120CT • (for IM30) 12" 120-tooth, 30mm Bore carbide saw blade with alternate bevel teeth specially designed for cutting aluminum and non-ferrous metal mouldings with wall thickness up to 3mm. • **\$193.61 each**

⚠ California Customers- WARNING: Cancer and Reproductive Harm - www.P65Warnings.ca.gov



Dust Collectors

- Designed to collect dust from small, medium and large machines.
- Filters are capable of permeability of 150 liters/min. dm² to 20 mm ca.
- Metal impellers and a powder-coated paint finish make for extreme durability.
- Low noise operation between 77 and 85 dB.
- Swivel castors enable total mobility.



EM-75A Dust Collector

- Item# EM-75A • \$987*
- 530 c.f.m.
 - 110-120 volt single phase
 - 16.4" main feed cable – no plug
 - 4" input diameter
 - 16"d x 35"w x 23"h
 - Weight 53 lbs., ship weight 64 lbs.



EM-100A Dust Collector

- Item# EM-100A • \$1080*
- 706 c.f.m.
 - 110-120 volt single phase
 - 5.9" main feed cable – no plug
 - 4" input diameter
 - 18"d x 32"w x 40"h
 - Weight 75 lbs., ship weight 84 lbs.



EM-200A/S Dust Collector

- Item# EM-200A • \$1512*
- 1200 c.f.m.
 - 220 volt single phase, 60 Hz
 - 4" input diameter
 - 20"d x 37"w x 67"h
 - Weight 108 lbs., ship weight 129 lbs.



EM-300A2 Dust Collector

- Item# EM-300A2 • \$2230*
- 2295 c.f.m.
 - 220 volt, 3 phase 60 Hz
 - 3 inlets of 4" each
 - 27"d x 58"w x 76"h
 - Weight 168 lbs., ship weight 206 lbs.

▲ California Customers- WARNING: Cancer and Reproductive Harm - www.P65Warnings.ca.gov



Underpinners

- Features exclusive clamp height adjustment
- Uses v-nails in color coded cartridges for soft or hard wood
- Include heavy duty drive hammers

- Foot pedal height adjustment (manual models)
- Powdered coated paint provides a durable finish
- Simple adjustment for the proper positioning of v-nails
- Easy insertion of v-nails, which are stackable



Model UP3-SE



Model UP3-PSE

Underpinner • UP3-SE

The UP3-SE underpinner has been specially designed for joining wood and plastic frames and is well suited for low and medium production frame shops and the semi-professional hobby trade. Production capacity is approximately 800 frames per 8 hour shift. Like the UP2-SE model, it does not require electricity or air source as the wedge is inserted by a heavy duty mechanical gear that is foot activated. Height adjustable foot pedal and vertical clamp height adjustment. Hard or soft v-nails can be used and can easily be stacked for shadowbox frames, etc. Powder coated finish for durability. Extension table available (see bottom of page).

Item #	Description	Each
UP3SE	Inmes Underpinner	\$818.00

Underpinner • UP3-PSE

The UP3-PSE is a pneumatic underpinner specifically designed for joining wood and plastic frames. This machine is well suited for medium and high production shops and the semi-professional hobby trade. Production capacity is approximately 1,000 frames per 8 hour shift. Compressed air is required for operation. Foot pedal administered air pressure. Exclusive vertical clamp height adjustment. Hard or soft v-nails can be used and can easily be stacked for shadowbox frames, etc. Powder coated finish. Extension table available (see bottom of page).

Item #	Description	Each
UP3PSE	Inmes Pneumatic Underpinner	\$1281.00

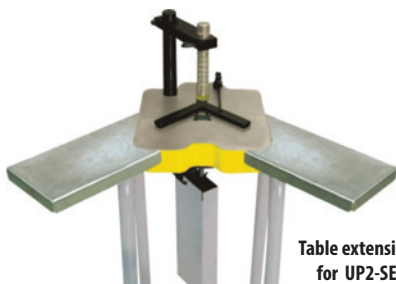

Table extension for UP2-SE



Table extension for UP3-SE and UP3-PSE

Table Extensions for UP2-SE, UP3-SE & UP3-PSE

These handy table extensions increases the work area on the joining plane of the UP2-SE, and UP3-SE & PSE, making it easier for supporting medium to large mouldings while underpinning. Angled platform allows for adding larger supports if desired. Easy to attach with standard tools.

Item #	Description	Each
2PTBL	Table Extension for UP2-SE	\$ 49.61
3PTBL	Table Extension for UP3-SE & UP3-PSE	\$152.25

⚠ California Customers- WARNING: Cancer and Reproductive Harm - www.P65Warnings.ca.gov



**UP5-PH
Pneumatic Underpinner**

- Features exclusive clamp height adjustment
- Comes complete with heavy duty tilting floor stand.
- Exclusive system for quick change of the v-nail size. Just turn the rotary knob allowing the use of v-nails in 5, 7, 10, 12, and 15mm heights.
- Include main air regulator, water separator, and system oiler.
- Top clamp is always exactly over the v-nails insertion point.
- Production capacity of 1000-1500+ frames per 8 hour shift.
- Offer a vertical and horizontal clamping system, enabling a quality join.
- Use hard wood or soft wood v-nails. No cartridge needed.
- The v-nail can be inserted in several positions once the main head set is adjusted.
- Stacks 2-3 nails one on top of the other.
- Powdered coated paint provides a long-lasting durable finish.
- Large machine leveling screws included.



Model UP5-PH

Model UP5-PH

Easy handling with pneumatic activation, offering precision joining with high productivity. Offers double adjustable clamps (hydraulic or mechanical) and front clamp, providing quality joining Joins moulding up to 6" wide. The v-nails can be inserted in several positions, as the solid steel hammer block is moved from one position to the next while the moulding and fence remain clamped and locked in one position. Now fitted with new finger adjust hydraulically linked adjustable twin pressure head, each with a soft-faced pressure pad.

Item# **UP5PH** • \$4384.00

Small extension table • Item# **5PSTBL** • \$135.45

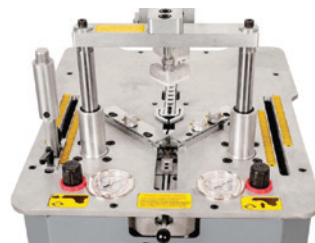

Model UP5-PH, top view



Model UP5-PH, top clamp system detail

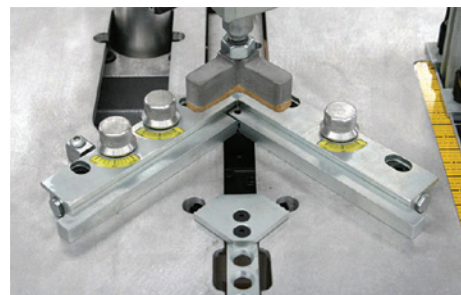

Extensions for Model UP4-P

Extension wings for UP4-P • Item# **4PTBL** • \$112.35

Small Table for UP4-P • Item# **4PSTBL** • \$ 93.45

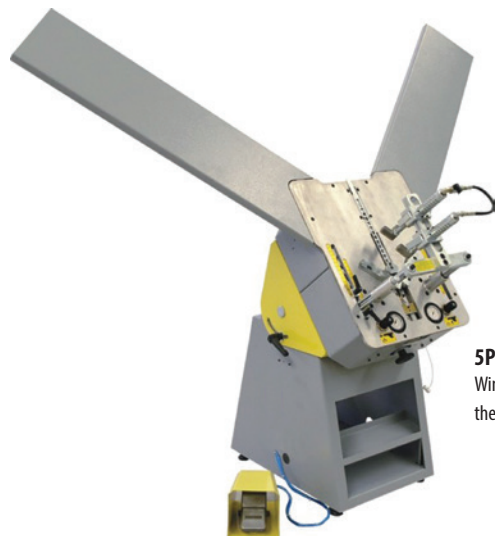

5PTBL

Wings extension shown on the UP5-PH (not included)

Wings Extension for UP5-PH

These support wings are an option for the UP5-PH underpinner. They are 33" in length and 9 1/4" wide, extending the table size to help to support larger frame sections and the widest of mouldings. Easily attaches to joining plane.
2 wings • Item# **5PTBL** • \$112.35



CM50D Air Compressor

The CM-50D air compressor is also virtually "noiseless" and fully automatic. Equipped with line pressure gauge, pressure regulator and moisture trap. *Specifications:* 110V/60hz 1/2 HP motor, 2.25 gallon storage tank, CFM 2.15 free air, operating Pressure 84 to 114 PSI. The 50-24 compressor can manage the requirements of most small picture frame or digital art businesses. 2.25 gallon tank, small size (15.5" x 15.5" floor space) shipping weight 70 pounds. • **Item# COMCM50D**

Item #	Description	Each
COMCM50D	CM50D Air Compressor	\$855



CM50 Air Compressor

The CM50 Silent Air Compressor is virtually "noiseless" and fully automatic. Line pressure gauge, pressure regulator and moisture trap. *Specifications:* 110V/60hz 1/2 HP motor, 6.0 gallon storage tank, CFM 2.15 free air, operating Pressure 85 to 115 PSI. The CM50 compressor can manage the requirements of most small picture frame or digital art businesses. 6 gallon tank, small size (15.5" x 15.5" floor space) shipping weight 70 pounds. • **Item# COMCM50**

Item #	Description	Each
COMCM50	CM50 Air Compressor	\$1097



CM99 Air Compressor

The CM99 Air Compressor is ideal for workshops with up to two underpinners operating simultaneously or over a long period of time daily. Each machine has 1 HP delivered from two motors with 4.35 CFM Free Air. Wheels are attached for ease of movement. • **Item# COMCM99**

- Air Pressure = up to 120 psi (8 bar)
- Pressure cycle = 85-115 PSI
- Shipping weight = 101 lbs
- Delivers 100 liters / minute

Item #	Description	Each
COMCM99	CM99 Air Compressor	\$1829



Morso Miter Choppers



**Morso-F
Foot Chopper**

- Foot operated-no need for a compressor or electricity
- Cut waste drops into a waste chute
- Cutting creates no dust
- 5-year warranty

Morso-F

This foot-operated chopper cuts double miters of 45 degrees, with a maximum cutting width of 4" and max. cutting height of 5¾". Comes equipped with safety guard, waste chute, sliding longitudinal stop, 59" measuring scale, adjustable fences (45-90°), and adjustable rabbit supports.

Item #	Description	Each
MORSOF	Morso F Foot Miter Chopper	\$4300



**Morso-H
Semi-Automatic
Pneumatic Chopper**

- As fast as a double-miter saw
- Cut waste drops into a waste chute
- Cutting creates no dust
- Noise level is below 62 dB

Morso-H

Morso-H is a semi-automatic, pneumatic mitring machine with a two-hand release built on. This makes the machine absolutely safe to operate as it is impossible to start the machine and touch the knives at the same time. Max. cutting width: 4", max. cutting height: 5¾". The Morso-H is delivered with: Two-hand release operation, safety guard, sliding longitudinal stop, waste chute, measuring scale up to 59", adjustable fences (45°-90°), and adjustable rabbit supports.

Item #	Description	Each
MORSOH	Morso-H Miter Chopper	\$7190

▲ California Customers- WARNING: Cancer and Reproductive Harm - www.P65Warnings.ca.gov



Morso Miter Choppers



**Morso-EHS
Electric/Hydraulic
Chopper**

- As fast as a double-miter saw
- Cut waste drops into a waste chute
- Cutting creates no dust
- Noise level is below 62 dB

Morso-EHS

The Morso EH is now available in a "noiseless" version, the **Morso EHS**. The motor has been removed from the machine and is housed in a separate box. The Morso-EHS noiseless miter chopper is a fully automatic, electric/hydraulic machine with a two-hand release built on. This makes the machine absolutely safe to operate as it is impossible to start the machine and touch the knives at the same time. Max. cutting width: 4", max. cutting height: 7". Delivered with: Two-hand release operation, safety guard, sliding longitudinal stop, second stop, waste chute, extension table for the left side, measuring scale up to 59", adjustable fences, 45°-90°, adjustable and automatic rabbet supports and clamping cylinders.

Item #	Description	Each
MORSOEHS	Morso EHS Miter Chopper	\$15890

Morso EH, EHT, EHL, & EHD are available as "noiseless"



**Morso-EH
Electric/Hydraulic
Chopper**

- As fast as a double-miter saw
- Cut waste drops into a waste chute
- Cutting creates no dust
- Noise level is below 70 dB

Morso-EH and Morso EHT Turbo

The Morso-EH is a fully automatic, electric/hydraulic mitring machine with a two-hand release built on. This makes the machine absolutely safe to operate as it is impossible to start the machine and touch the knives at the same time. Max. cutting width: 4". Maximum cutting height: 7". The Morso-EH is delivered with two-hand release operation, safety guard, sliding longitudinal stop, second stop, waste chute, extension table for the left side, measuring scale up to 59", adjustable fences (45-90°), adjustable and automatic rabbet supports and clamping cylinders. The **Morso-EHT Turbo** is the same machine as the Morso-EH, but the work cycle is 50 percent quicker.

Item #	Description	Each
MORSOEH	Morso EH Miter Chopper	\$14680
MORSOEHT	Morso EHT Miter Chopper	\$17300



Morso Chopper Blades

The tool steel used for the cutting edge on the Morso blade is formulated of Austrian steel with a Rockwell hardness of 64. The cutting edge is attached to the tool's body and then carefully heat tempered. The knife is then precision surface ground to thickness, hollow ground with the grinding wheel between 8" and 10" diameter at 30° to the face of the knife, then hand-honed and deburred. No other blade on the market can offer the precision and longevity of a Morso blade. There are no generic blades made to the same Rockwell hardness, and in many cases, they are not hollow ground or hand honed.

Item #	Description	Each
2553	Standard Morso Knives Fits F, H, & EH/EHT/EHS choppers	\$446.25
2553A	Morso Reversible Chopper Blade Set	\$565.04

Rabbet Support System

This automatic rabbet support system is ideal for production work, i.e. jobs that have repetitive cuts. Automatically reset the rabbet support to the adjusted width and height of the moulding after each cycle. Saves time on manual adjustments. Includes easy-to-follow fitting instructions. For installation on Morso-F and Morso-H choppers; The automatic rabbet support system is standard on all electric machines.

Item #	Description	Each
MORSORSS	Automatic Rabbet Support System Fits Morso F & H choppers	\$Call



Morso Fillet Cutter

Cuts small wooden and plastic fillets of 1" x 3/4" exactly in 45 degrees. A light, very portable machine that can be placed around the shop, weighing only 21 lbs.

Knives are genuine Morso knives that can be resharpened when needed.

Item #	Description	Each
MORSOB	Morso B Bench Miter Chopper	\$799



Cutting Machines



User-Friendly Software Tools:



VALIANI

Mat Pro Ultra

The Right Machine for Your Operation.

Isn't time to retire your old Computerized Mat Cutter?

- Unlimited use rentals starting at only \$345 per month!
- Purchase Systems starting at only \$15,995!



Mat Pro Ultra V

Designed with the aim of increasing the production capabilities of small to medium sized businesses whose target is to own a machine that can also handle foldable and rigid materials used for packaging and product displays.



Supreme - iS

Developed for busy frame shops looking for a more robust mat cutting solution and, therefore, turns out to be the ideal choice for Custom framers or low volume production framers.



Plus - iS

Developed and constructed for production framing businesses, and custom framers looking for the best CMC available. Available in two sizes and is capable of doing all cutting from the front and the back, cuts single or multiple openings, V-grooves and pre-assembled double and triple mats.



Libra

Libra is the perfect mat cutter for professional framers, born to assist the user with excellent performance and extreme precision. The Libra is targeted at companies with medium volume production that require robust and reliable equipment.



Geminus - iV

The Geminus-iV is the all-in-one solution for any type of cutting, drawing or scoring process that your operation requires. The Geminus is designed for high volume production, featuring dual-bay two station cutting of matboards and more.

VALIANI means...

- ✓ High quality Italian Engineering
- ✓ Precision & Creativity
- ✓ Versatility
- ✓ Reliability & Profitability
- ✓ Superior Customer Support



Supports Interchangeable Heads

For Pricing & Information on Valiani Computerized Mat Cutters, call Omega today at 1-800-289-6634

California Customers - WARNING: Cancer and Reproductive Harm - www.P65Warnings.ca.gov

"Month to Month" Rental Programs - Unlimited Use

Prices listed below reflect pricing at the time of printing. Please contact Omega to get up-to-the-minute pricing.

Mat Pro® Ultra	Basic Package	Custom Package	Mat Pro® Ultra BC	Basic Package	Custom Package
User License Fee (one time only)	\$900	\$900	User License Fee (one time only)	\$900	\$900
Monthly Rental Fee (first 36 payments)	\$345 /mth	\$395 /mth	Monthly Rental Fee (first 36 payments)	\$395 /mth	\$445 /mth
Monthly Rental Fee (after 36 payments)	\$200 /mth	\$250 /mth	Monthly Rental Fee (after 36 payments)	\$250 /mth	\$300 /mth

Size 150 CMC (60" x 40") only - Includes your choice of machine stand: 2 Position Combo Horizontal, Vertical or Table-Top

Purchase Pricing

Machine Model	Size Available	Basic Package	Custom Package
Mat Pro® Ultra	100 CMC (40" x 32")	\$15,495	\$17,495
	120 CMC (48" x 32")	\$15,795	\$17,795
	150 CMC (60" x 40")	\$16,995	\$18,995
	XXL CMC (104" x 60")	\$35,995	\$37,995
Mat Pro® Ultra BC	150 CMC (60" x 40")	\$21,995	\$23,995
	XXL CMC (104" x 60")	\$39,995	\$41,995
Mat Pro® Ultra V	150 CMC (60" x 40")	\$25,995	\$27,995
Supreme®-i	120 CMC (48" x 32")	\$26,795	\$28,795
	150 CMC (60" x 40")	\$26,995	\$28,995
	260 CMC (104" x 46")	\$54,995	\$56,995
Plus®-i	120 CMC (48" x 32")	\$36,995	\$38,995
	150 CMC (60" x 40")	\$37,995	\$39,995
	150 DS CMC (60" x 40")	\$42,995	\$44,995
Libra®-i	CMC (67" x 49")	\$48,995	\$50,995
Geminus® - i	CMC (74" x 49")	\$69,995	\$71,995

Basic Package Includes : 40° Green Cutting Head, choice of stand (Mat Pro Ultra only), Dell® Computer System w/ Windows 8, V-Studio software, stainless steel slip-sheet (non vacuum, standard size machines only), 1 box of L100 extended life blades, two (2) years of unlimited technical support and two (2) year factory warranty on all non-wear parts. One (1) year manufacturers warranty of computer system. All warranties begin on the date of shipment.

Custom Package Includes : The complete Basic Package plus the 45° "Blue" or 45° "Red" cutting head, 90° Grey cutting head and "Gold" MatStylus Deluxe Drawing head.



Valiani ASTRA Manual Mat Cutter

The Valiani Astra 120/150 bench top mat cutting machine has evolved to the next level. The Astra is available in cutting capabilities of 1200mm (48") and 1500mm (60") and cuts mats of varying thickness. The machine, as standard, is supplied with magnetic stops, measuring stops, easy to use blade holder and an extension arm. The cutting head slides on four ball bearings which glide on two sturdy non-warping tempered steel tracks constantly cleaned by four small brushes placed beneath it. The measuring stops are simply adjusted and allow precision cuts on all 4 sides of the mat board, therefore drastically reducing overcuts and undercuts.

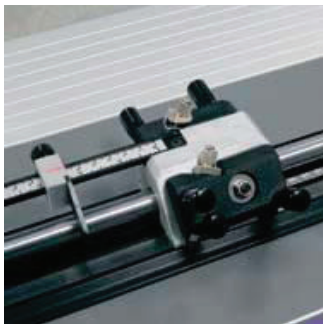

Each cutting head rotates 45° and 90° on two ball bearings. This makes cutting effortless eliminating operator hand and wrist fatigue. The aluminum mat guide, in perfect alignment with the cutting head, ensures an accurate cut on the entire surface of the mat.

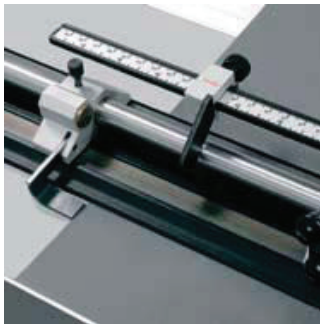

The magnetic stop is a revolutionary feature. Cutting is quicker and more precise. It eliminates the necessity of resetting the opening dimension stops for all 4 sides since the magnets automatically adjust to the external mat size and cuts mats of varying sizes without resetting the stops when you maintain the same border size. The magnetic stops will increase your production.



The blade holder is manufactured using high precision technology. It allows you to easily alter the blade depth by simply turning the adjustment screw to reduce or increase depth and ensures a perfectly straight cut at all times. Cuts mats of varying thickness from paper to mat boards up to 3.5mm (8 ply) thick.

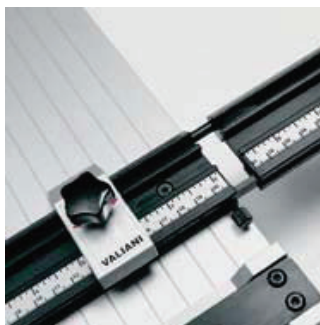

The right side extension arm allows for cuts of up to 120cm (48"). Simple to insert, it provides rigid and stable support for acquiring and cutting to size large mat boards. Includes a measuring stop to help set up the mat dimensions.

Innovative Italian Design

The cutting head slides on four ball bearings which glide on two sturdy durable tempered steel tracks that are constantly cleaned by two small brushes. This reduces wear and helps keep the cutting motion smooth and straight – even with heavy use. The magnetic stop is a revolutionary Valiani feature, making routine cutting quicker and more consistent, even for multiple operators. The cutting head stop scale eliminates the necessity of resetting the start of cut dimension stop for each side, since the stop guide automatically references to the external mat size and maintains the same border size. The magnetic stop will increase your production rates – without over or undercutting.

Fully Loaded - Right out of the box

The Astra is fully accessorized in its standard version – supplied with precision magnetic stops, integrated clamp lifting lever, precision blade-holding cartridges, and a right-side extension arm for board sizing. Don't pay extra for the features you need most!

The most copied manual mat cutter, ever.

The Valiani Astra 120/150 mat cutter has several features that have been copied by other manufacturers over the years, but never duplicated as a complete system. A classic, simple and supremely reliable machine, the Astra was (among) the first machine(s) to use a warp-free aluminum base, and introduced the industry's first magnetic stops. The Astra is available in cutting capacities of 49"-120" model and 61"-150" model.

Micro-adjustable Blade Cartridges

Another industry first – the bevel and straight (90°) blade holders are manufactured using high precision machining technology. The rigid, pointed-tip blade is precisely positioned in the cartridge, with a simple micro-adjustable depth adjustment screw to reduce or increase depth and ensure a perfectly straight "hook-free" cut at all times. The Astra allows you to quickly and consistently set blade depth for mats of varying thicknesses; from the thinnest foil mat on up to 8-ply (3.5mm) thick rag board.

Item #	Description	Price
AST120	Valiani Astra 120 Manual Mat Cutter	\$1495
AST150	Valiani Astra 150 Manual Mat Cutter	\$1995

▲ California Customers- WARNING: Cancer and Reproductive Harm - www.P65Warnings.ca.gov

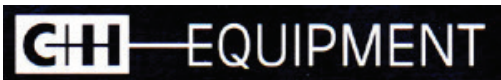

C+H Advantage Pro Mat Cutters

With over 40 years of advancements and innovation the C&H Advantage PRO from Nielsen Bainbridge has been a leader in mat cutters. Available in 2 sizes (48" and 60") with a uniquely designed squaring arm that is included along with the latest measuring stop for increased speed and accuracy found on Pro Plus models only. A one point Mat Guide adjustment for quick & easy setting of the mat boarders. The cutting head rides on a 5/8" precision steel rod which connects to a pair of heavy duty hinges, all attached to a sturdy laminated MDF base. These units are the best value for the money and will give you many years of service.

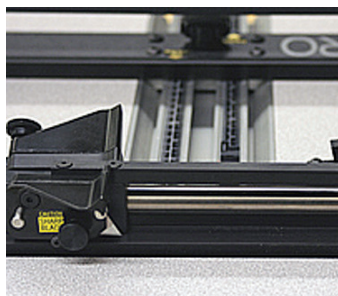

Item #	Model	Each
4607	48" C&H Advantage Pro Mat Cutter	\$1496.00



• C+H Mat Blades
See Page 21

Item #	Accessory	Each
4615-36	Squaring Arm (36") for C+H Advantage Pro	\$104.74
4606	Production Stops for 60" C&H Advantage Pro LE	\$203.96

C+H BG6100 Vertical Wall Cutter

The C & H BG6100 Wall Mounted Board and Glass Cutter takes the stress out of cutting glass, foamboards and matboard. The BG6100 has a twin cutting head, so there is no need for a blade or head change when switching between glass and foamboard, and can clamp material up to 1/2" (13mm) thick.

- Space saving, wall mounted cutting solution for glass, acrylic, foamboard & matboard
- Self-lubricating twin cutting head switches between glass and foamboard/matboard, with no tool changes required
- Twin handle cutting head for cutting balance control
- Heavy-duty, Teflon coated clamp / v-rail assembly provides a stable track for the cutting head and holds board and glass securely in place, up to 1/2" (13mm) thick
- Line of sight cutting edge along the clamping bar offers clear visual reference, allowing the trimming of mounted art right to its edge easily and without guesswork
- Vertical measuring scale allows quick reference of material dimensions in both width and height
- Production flip-stop to assist with repeating the same dimensions for high volume work

Item # 4620	C+H BG6100 Vertical Wall Cutter	\$2354
-------------	---------------------------------	--------



Twin Handle Cutting Head



V-Rail Clamping Lever



Vertical Measuring Scale



Line of sight cutting edge



Production Flip Stop



Cuts Foam Board up to 1/2" thick

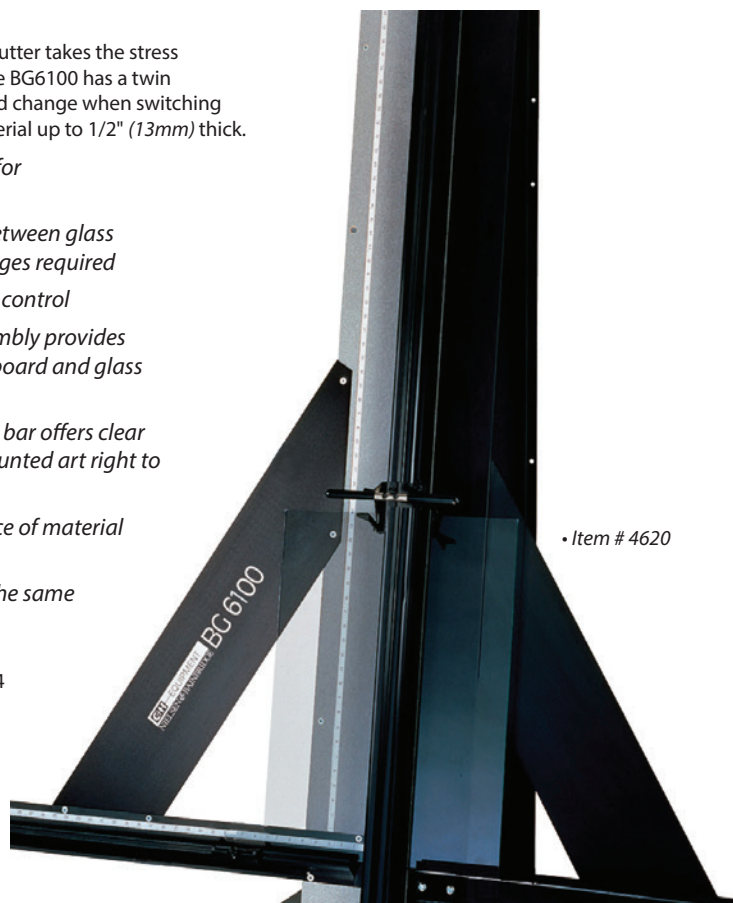

• Item # 4620

Foster Keencut

Omega is the master distributor for Keencut products for the framing industry in North America

Excalibur 1000X & 5000 Vertical Cutter

The unique Excalibur 5000 features two cutting heads with four different cutting tools mounted on the same head for instant selection. The counterbalance ensures an easy glide cutting action, prevents damage when loading sheet materials, minimizes operator fatigue and increases production. The Twin Wheel Cutting Head cuts 1/8" uncoated masonite and mat board. A standard medium duty utility blade accurately cuts Foam-board, Gatorboard, Sintra, corrugated cardboard, coroplast up to 1/2" thick. The scoring blade is used for acrylics and other rigid plastics. The tungsten carbide cutting wheel scores glass and mirrors up to 1/4" thick.

The Excalibur 1000x series vertical cutter features a single sliding counter-balanced head with 3 cutting and scoring tools ready for instant use. With a rigid clamping system, a set-for-life squaring mechanism and the standard wall mounting or optional free-standing kit, the Excalibur 1000X provides a noiseless, dust-free and cost effective cutting solution for materials used in a modern sign or graphic workshop.

- Easiest vertical cutter to keep square
- Ready mounted integral tools with rotating wheel for maximum convenience
- Control for cutting rigid PVC up to 1/2" thick
- Wall mounting kit included
- Pressure sensitive clamp
- Complete set of production stops
- Fitted counterbalance (Excalibur 5000 only) – less fatigue, accidents & easy loading of materials
- Single cut line & sightline strip for maximum accuracy with all tools
- 5 Year guarantee (excluding replacement cutting wheels)
- 20 Year free replacement on all bearings

Item #	Model	Each
EXC1000X	Keencut 1000X 63" Vertical Cutter	\$2937.48
EXC5000	Keencut 5000 63" Vertical Cutter	\$3532.62

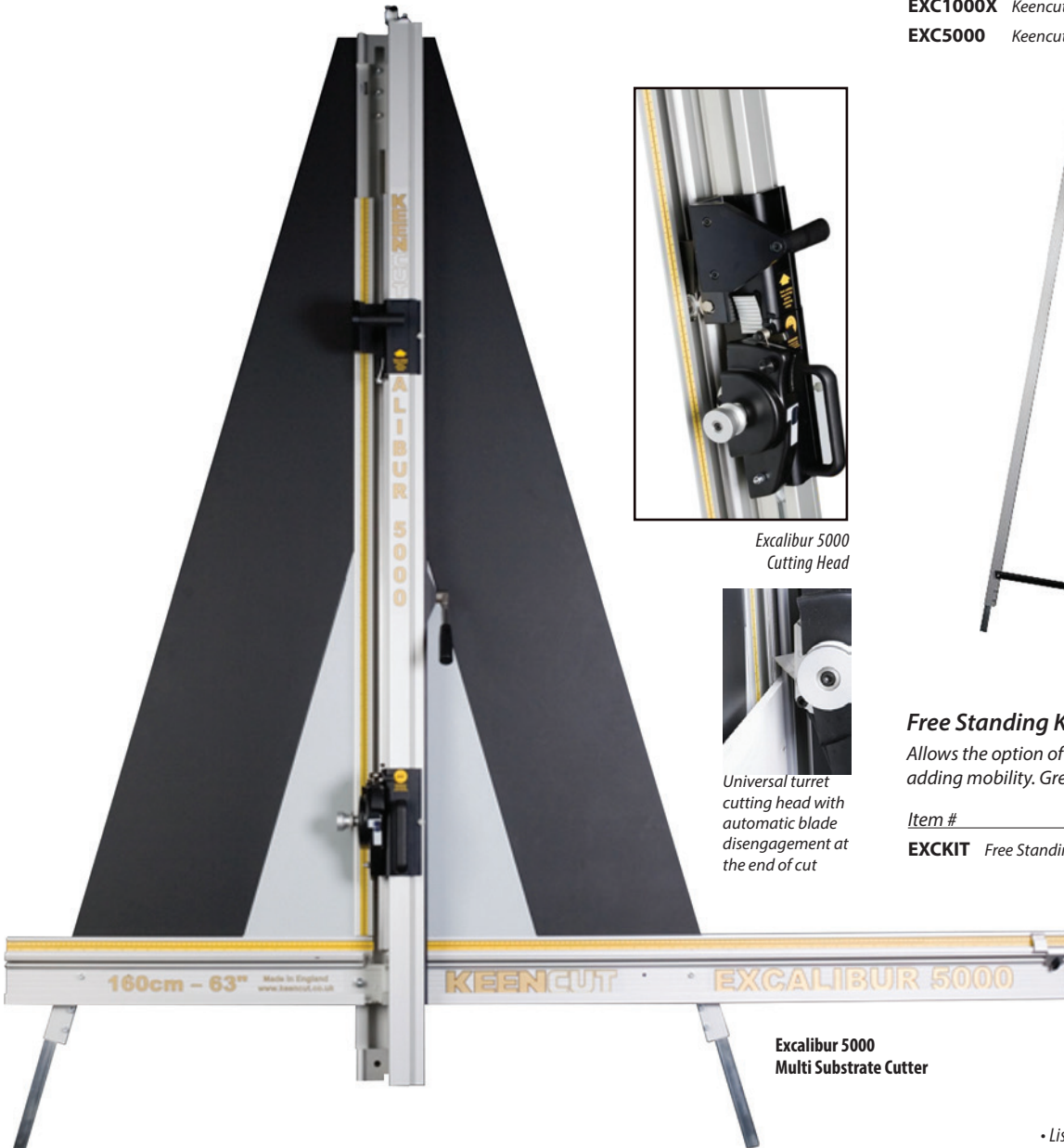

Excalibur 5000 Cutting Head



Universal turret cutting head with automatic blade disengagement at the end of cut



Free Standing Kit for 63" 1000x & 5000

Allows the option of not mounting to a wall while adding mobility. Great for larger production facilities.

Item #	Description	Price
EXCKIT	Free Standing Kit for Excalibur Cutters	\$338.52

Excalibur 5000 Multi Substrate Cutter

• List prices shown; Call for current specials

Foster Keencut

Vertical Cutters • Parts & Accessories

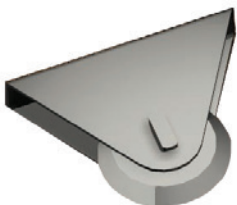

Tungsten Carbide Glass Scoring Wheel

Tungsten carbide glass scoring wheel is made of high quality carbide, precision machined and built for extra durability and long scoring life. Lasts for months. Made especially for Keencut multi-substrate cutters.

Item #	Description	Each
TCGLCWH	Tungsten Carbide scoring wheel	\$ 17.20



Glass Cutting Cartridge

For older versions of the Excalibur 1000x (Single Tool cutter) holds carbide scoring wheel for insertion into the cutting head.

Item #	Description	Each
GLCUTCAR	1000x Glass Cutting Cartridge	\$200.66



Medium Duty Blade

• Expertly crafted in England from Sheffield Steel!



Heavy Duty Blade (.080)

Board Cutting Blades

Medium and Heavy Duty blades for cutting cardboard, foam board, Gator Board, Coroplast, and Sintra. Made in England from world-renowned Sheffield Steel, provides a longer life and superior edge for performance cutting up to 1/2" thick.

Item #	Description	Each
MDBLADES	Medium Duty Blades (100)	\$ 25.80
HDBLADES	Heavy Duty Blades (100)	\$ 41.27



Sightline Strips

Sight-line strip is fixed to the clamp and then trimmed by the cutting blade to give an accurate guide when cutting to trim lines, the edge of an image or pencil marks. For Excalibur Series vertical cutters (Pack of 3 strips)

Item #	Description	Each
EXCSLSTR	Pack of 3 Sightline Strips	\$ 45.86



Composite Twin-Wheel Cutter Head

The twin-wheel head shears 1/8" Masonite, heavy mat board and 3/8" PVC board.

Item #	Description	Each
CTWHCH	Composite Twin Wheel Cutter Head	\$154.79



Twin-Wheel Replacements

Replacement wheels attach to twin-wheel head with attached hardware.

Item #	Description	Each
TWCREPW	Replacement wheels for cutter	\$ 86.00

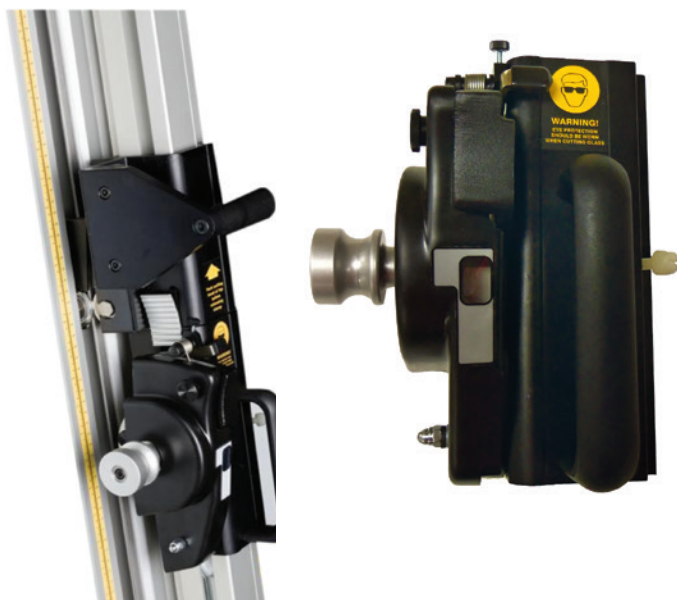

Excalibur 5000 Complete Cutting Head Replacement

This unit houses four precision cutters in one: a twin-wheel cutting head, a utility blade, a scoring blade for acrylic and a tungsten carbide glass scoring wheel. Designed exclusively for the Excalibur 5000, it features the turret cutting head that enables the user to easily switch between cutters for different materials. Assembly instructions included.

Item #	Description	Each
CCHREP	Excalibur 5000 Complete Cutting Head	\$1015.35

• List prices shown; Call for current specials

▲ California Customers- WARNING: Cancer and Reproductive Harm - www.P65Warnings.ca.gov

Foster Keencut

Manual Mat Cutters



Ultimat Gold

Tough, precise, built to last and exceptionally comfortable to use, the Keencut Ultimat Gold takes the guess work out of creating perfect mats. Offering superior micro-adjustments and space-age bearings that provide silent-glide action, the Ultimat Gold is built for precision, ease of use and versatility.

Unrivaled Features and Dual Cutting Head

- The precision cutting head has a comfortable sculpted shape and features ball-and-thrust bearings for superb precision.
- The dual cutting head features both beveled edge and vertical blade holders.
- The vertical head can be locked into position to allow easy cutting of the thickest boards.

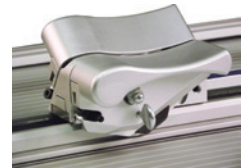

Item #	Model	Each
ULTGLD40	40" Ultimat GOLD	\$1801.80
ULTGLD48	48" Ultimat GOLD	\$1850.94
ULTGLD62	62" Ultimat GOLD	\$1981.98

Upgrade Kits for the original Ultimat Gold & Ultimat Purple models

This kit upgrades existing Ultimat & Ultimat Gold mat cutters to the new Ultimat Futura capabilities. Includes Futura Slideaway, cutting head, and stop system.

Item #	Upgrade Kit for:	Each	Item #	Upgrade Kit for:	Each
UGFUT40	40" Ultimat GOLD	\$ 671.58	UPFUT40	40" Ultimat (Purple)	\$ 671.58
UGFUT48	48" Ultimat GOLD	\$ 709.80	UPFUT48	48" Ultimat (Purple)	\$ 709.80
UGFUT62	62" Ultimat GOLD	\$ 780.78	UPFUT62	62" Ultimat (Purple)	\$ 780.78

Keencut Mat Blades:

Item #	Blades (QTY)	Each
TSBL012	Tech S .012 (100ct)	\$ 40.13
TSBL015	Tech S .015 (100ct)	\$ 40.13
TDBL012	Tech D .012 (100ct)	\$ 40.13
TDBL015	Tech D .015 (100ct)	\$ 40.13



Ultimat Futura

With the creation of the Ultimat Futura, we've made the Ultimat Gold (above) even better. Featuring a new cutting head with self-aligning roller bearings, the Ultimat Futura represents the future of manual mat cutters – and offers the smoothest cut ever.

The Ultimat Futura Includes:

- Switchable magnetic blade holders for cutting different thicknesses
- Large-diameter roller thrust bearings on the cutting head for total control of both blade carriers. No flex, side play or hooks.
- Base plate that accommodates all accessories.
- Roller lift and hold system.
- Patented micro-stops.

Item #	Model	Each
ULTFUT40	40" Ultimat Futura	\$1992.90
ULTFUT48	48" Ultimat Futura	\$2102.10
ULTFUT62	62" Ultimat Futura	\$2211.30

Futura Accessories:

Item #	Futura Accessory	Each
BESA24	2x Base Extension Support Arm 24"	\$ 131.86
MARGUKIT	30" Extended Margin Guide Kit	\$ 234.78
MACGAUG	Multi-angle Cutting Gauge	\$ 206.39
REVBEVST	Reverse Bevel Stop	\$ 91.73



Extended Margin Guide Kit

• List prices shown; Call for current specials

⚠ California Customers- WARNING: Cancer and Reproductive Harm - www.P65Warnings.ca.gov

Foster Keencut

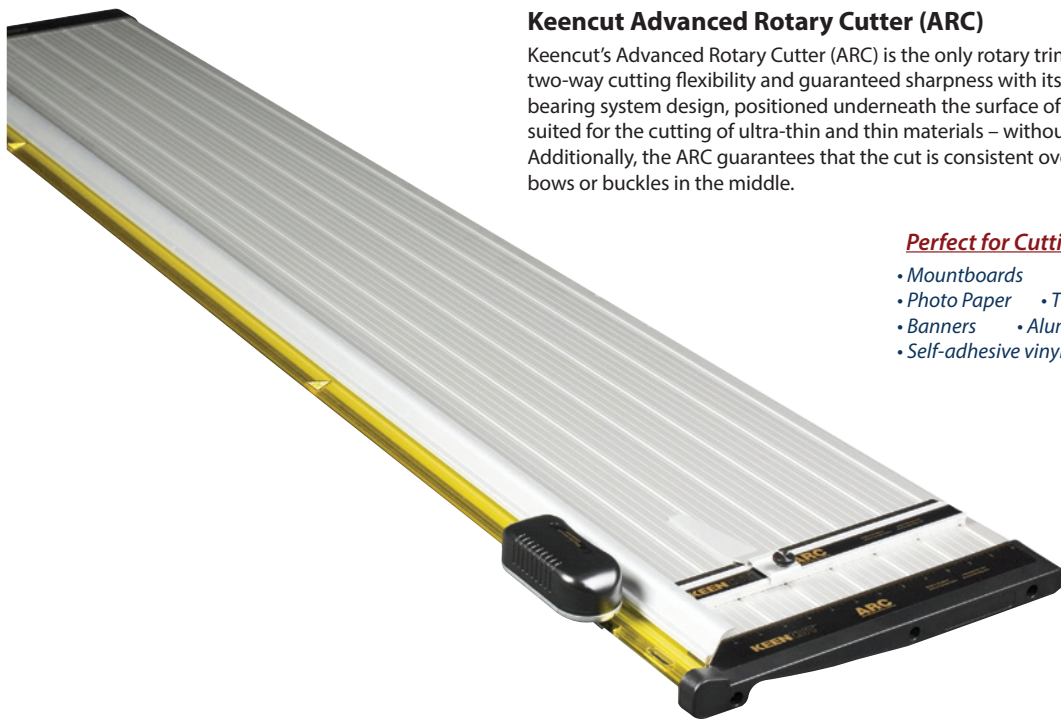

Keencut Advanced Rotary Cutter (ARC)

Keencut's Advanced Rotary Cutter (ARC) is the only rotary trimmer with dual cutting wheels, providing two-way cutting flexibility and guaranteed sharpness with its tungsten steel blades. Its unique monorail bearing system design, positioned underneath the surface of the baseboard, makes the ARC specifically suited for the cutting of ultra-thin and thin materials – without buckling on the edge of the blade. Additionally, the ARC guarantees that the cut is consistent over the entire length of the material – no bows or buckles in the middle.

Perfect for Cutting:

- Mountboards
- Paper
- Photo Paper
- Tissue
- Film
- Banners
- Aluminum plate (.004")
- Self-adhesive vinyl
- Flexible sheet materials

Item #	Model	Each
RT60606	42" Rotary Cutter	\$600.60
ARC60	60" Rotary Cutter	\$840.84

Laser Trued Steel Tip Straight Edges

The laser-trued Foster Keencut Straight Edge, in silver anodized aluminum, is a superb straight edge for use in marking, drawing, scoring or cutting. In fact it can be used with all types of hand-held tools where accuracy is required. The Safety Straight Edge is strong, precise and portable and comes fitted with two full-length grip strips to steady the straight edge and protect sensitive surfaces. Safety Straight Edges are safe to use with the integral finger guard and a full-length stainless steel bead to resist wear to the edge and the tools. These tools are available in seventeen convenient sizes.

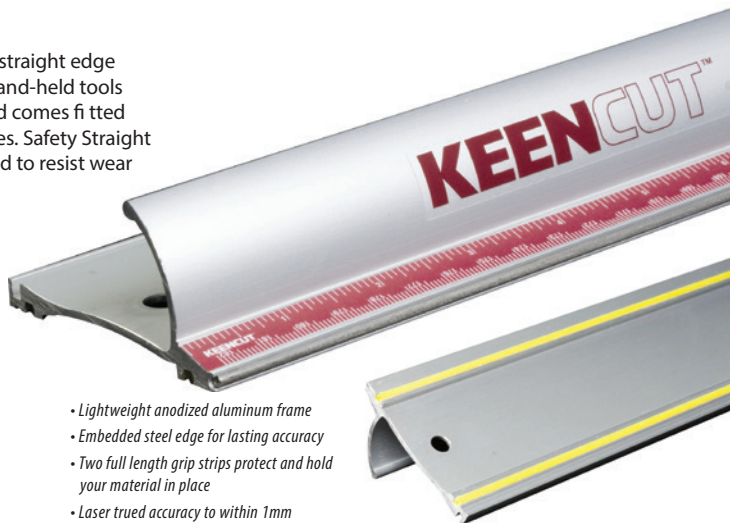

Item #	Length	Each	Item #	Length	Each
SSE18	18" straight edge	\$ 74.53	SSE60CM	60cm straight edge	\$ 91.73
SSE24	24" straight edge	\$ 91.73	SSE75CM	75cm straight edge	\$103.19
SSE30	30" straight edge	\$103.19	SSE90CM	90cm straight edge	\$114.66
SSE36	36" straight edge	\$114.66	SSE105CM	105cm straight edge	\$131.86
SSE42	42" straight edge	\$131.86	SSE120CM	120cm straight edge	\$143.33
SSE48	48" straight edge	\$143.33	SSE135CM	135cm straight edge	\$149.06
SSE54	54" straight edge	\$149.06	SSE150CM	150cm straight edge	\$160.52
SSE60	60" straight edge	\$160.52	SSE180CM	180cm straight edge	\$171.99
SSE72	72" straight edge	\$171.99			

- Lightweight anodized aluminum frame
- Embedded steel edge for lasting accuracy
- Two full length grip strips protect and hold your material in place
- Laser trued accuracy to within 1mm

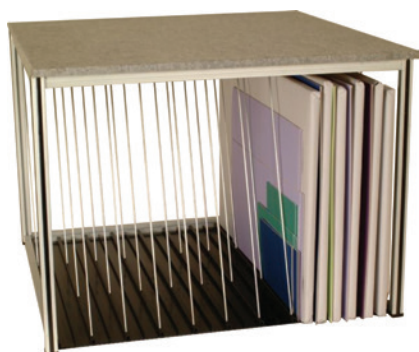

Keencut Mat Board Storage Unit

This Matboard Storage Unit helps maximize use of space in small shops and provides significant savings on storage costs. Additionally, it combines as a great work table for your Ultimat mat cutter. Avoid edge damage by storing your unwrapped matboard and finished frames in this sturdy unit. The smooth internal base that includes heavy-duty interlocking extruded plastic channels allows unwrapped mat board, or even finished frames, to be slid in or out without edge damage.

Item #	Model	Each
MBSTOR7	7-slot storage unit	\$802.62
MBSTOR10	10-slot storage unit	\$999.18

• List prices shown; Call for current specials

California Customers- WARNING: Cancer and Reproductive Harm - www.P65Warnings.ca.gov



Crescent Accents™

Decorative patterns on alpha-cellulose conservation matboard

Crescent Accents

Crescent Accents are 100% virgin alpha-cellulose, conservation-grade matboards with printed decorative surface patterns.

- Conservation grade surface papers for optimum bleed and fade resistance
- Facing papers exceed minimum standards for fade and bleed as set by F.A.T.G.
- 100% virgin alpha-cellulose surface, core and backing papers
- pH 8.0-9.5. Buffered with calcium carbonate to an alkaline reserve of 3-5%
- Available in 32"x40" and 40"x60"

Recommended For:

- Fine Art Prints
- Limited Editions
- Valuable Documents
- Photography

REGULAR MATBOARD

Decorative Matboard

Decorative Matboards, with a light cream core, provide an unrivaled range of colors and textures for traditional non-conservation framing.

- Decorative facing papers
- Natural cream core and backing
- Surface, core and backing paper buffered with calcium carbonate to alkaline reserve of 3-5%
- Available in 32"x40" and 40"x60"

Recommended For:

- Decorative framing and general presentations
- Open end reproductions
- Posters and decorative art

Crescent Select™

Alpha-cellulose conservation matboard

Crescent Select Matboards

Crescent Select Matboards are made of alpha-cellulose (wood pulp) fibers that have been chemically treated to eliminate the acids and lignins that can degrade the matboard and the artwork. Alpha-cellulose based matboards are suitable for minimum levels of conservation framing and as an alternative to non-conservation matting.

- Conservation grade surface papers for optimum bleed and fade resistance
- Facing papers exceed minimum standards for fade and bleed as set by F.A.T.G.
- 100% virgin alpha-cellulose surface, core and backing papers
- pH 8.0-9.5. Buffered with calcium carbonate to an alkaline reserve of 3-5%
- Available in 32"x40" and 40"x60"

Recommended For:

- Fine Art Prints
- Limited Editions
- Valuable Documents
- Photography



International Whitecore

International Whitecore, a non-conservation white core matboard, provides the aesthetic and design benefits of a bright-white bevel.

- Decorative facing papers
- Stay-white core and backing
- Surface, core and backing paper buffered with calcium carbonate to alkaline reserve of 3-5%
- Available in 32"x40" and 40"x60"

Recommended For:

- Decorative framing and general presentations
- Open end reproductions
- Posters and decorative art

ULTIBLACK™

Crescent Select UltiBlack

Crescent Select UltiBlack Matboards are made of alpha-cellulose (wood pulp) fibers that have been chemically treated to eliminate the acids and lignins that can degrade the matboard and the artwork. Alpha-cellulose based matboards are suitable for minimum levels of conservation framing and as an alternative to non-conservation matting.

- Conservation grade surface papers for optimum bleed and fade resistance
- Facing papers exceed minimum standards for fade and bleed as set by F.A.T.G.
- 100% virgin alpha-cellulose surface, core and backing papers
- pH 8.0-9.5. Buffered with calcium carbonate to an alkaline reserve of 3-5%
- Available in 32"x40" and 40"x60"

Recommended For:

- Fine Art Prints
- Limited Editions
- Valuable Documents
- Photography

BriteCores™

Crescent BriteCores

BriteCores are two-sided conservation quality matboards. They feature brightly colored cores with matching surface papers on one side and a white or black surface paper on the other side

- Acid-free and lignin-free
- Extra-thick bright-colored conservation cores with matching conservation surface papers
- Colors pigmented for bleed and fade resistance
- Buffered with calcium carbonate to an alkaline reserve of 3-5%

Recommended For:

- Limited edition prints
- Contemporary color photography
- Sports Memorabilia & Animation cels



Black Core

Black Core Matboard

Black Core Matboards add contrast and drama to non-conservation framing.

- Decorative facing papers
- Solid black core and backing
- Exclusive non-scuff backing paper
- Surface, core and backing paper buffered with calcium carbonate to alkaline reserve of 3-5%
- Available in 32"x40" and 40"x60"

Recommended For:

- Decorative framing and general presentations
- Open end reproductions
- Posters and decorative art



Crescent Rag Mat 

For centuries, cotton rag paper, prized for strength, purity and stability, has been the choice of artists, writers and printers. Today it is specified for currency, stock certificates and government documents. Cotton rag matboard was designed specifically for the Metropolitan Museum of Art in New York in the late 1920s.

Today, virtually all museums and libraries rely on cotton rag matboard, often referred to as museum board. Crescent's entire line of cotton **RagMat**, the industry's most trusted brand of cotton rag matboard, is still produced following the time-honored practice of making paper from cotton fiber. It's a Crescent tradition that continues to stand the test of time.



Cotton RagMat is...

QUALITY: Cotton RagMat is the only mounting and matting board guaranteed safe next to any artwork. The quality of cotton RagMat is simply unsurpassed and is the natural choice when the highest levels of protection are required.

NATURAL: Cotton is naturally acid-free and lignin-free. Cotton RagMat is processed without harsh chemicals or additives.

TIME-TESTED: For over 1500 years cotton has been both the courier and curator of history. Priceless documents such as the Gutenberg Bible, Shakespeare's first folio, and the U.S. Constitution and Bill of Rights exist today because they were penned on cotton paper.

ENVIRONMENTALLY FRIENDLY: Cotton is an annually renewable resource. Cotton RagMat is processed without harsh chemicals or additives.

TRUSTED: Cotton is preferred by museums and preservationists and has been trusted by artists, historians and writers for centuries.

GUARANTEED: Cotton RagMat is guaranteed safe next to artwork. RagMat is the only matting and mounting board backed by a lifetime warranty.

RagMat meets museum conservation standards as set by the Fine Arts Trade Guild. Made of strong cotton fibers, which are naturally acid-free and lignin-free it is also annually renewable and environmentally friendly. Cotton RagMat is the only matboard guaranteed safe next to any artwork.

- Facing papers exceed minimum standards for fade and bleed as set by F.A.C.T.S. and F.A.T.G.
- pH 8.5 - 9.5
- Buffered with calcium carbonate to an alkaline reserve of 3 -5% (except RagMat Museum Solids - Unbuffered)
- 4 ply and 8 ply thicknesses. (Consult color specifier)
- Meets Museum Standards as set by F.A.C.T.S. and F.A.T.G.

Intended for:

- Valuable works of original art
- Surface papers are pigmented for fade and bleed resistance.
- Items of historical importance

MOORMANTM
FABRIC MATBOARD

Crescent's exclusive Moorman line of matboard delivers unparalleled quality, elegant color, rich texture and the style of European craftsmanship.



White Core Suede

High quality fade and bleed resistant suede surfaces on premium white conservation core and backing



Black Core Suede

High quality fade and bleed resistant suede surfaces on decorative black core and backing

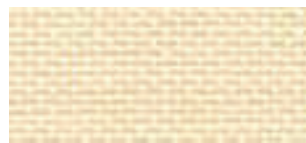

Natural Linen

Richly textured fade and bleed resistant linen surfaces on premium white conservation core and backing



Linen

Classic tightly-woven linens on premium white conservation quality core and backing

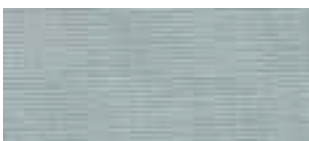

Sheer Silks

The subtle elegance and soft sheen of silk on premium white conservation core and backing



Rustic Linen

Traditional linen on premium white conservation quality core & backing



Pacific Linen

Stylish linens with the look of pulled-thread on premium white conservation quality core and backing



Leather & Club Leather

Beautifully styled, richly textured leathers on black core and backing

⚠ California Customers- WARNING: Cancer and Reproductive Harm - www.P65Warnings.ca.gov



• All prices shown are per sheet.

PAPER MATBOARD • 32 x 40 (4 Ply)						1-24:	25-49:	50+:
C33	White & Cream Smooth					5.27	4.90	4.37
C34	White & Cream Pebble					5.79	5.38	4.80
C900	Red	C905	Violet	C912—India	C918	Very White		
C902	Yellow	C907	Wine	C915	Fog			
C903	Soft Green	C909	English Rose	C916	Autumn Mist			
C921A	Smooth Black					6.51	6.05	5.40
C924	Dark Gray	C935	Copely Gray	C948	Sand			
C934	Pearl	C939	Dark Green	C960	White			
C961	Cream	C972	French Blue	C978	Congo Green	C986	Tampico Brown	
C962	French Gray	C974	Dawn Gray	C979	Dusk	C987	Palm Beach White	
C968	Old Gold	C975	Stone Gray	C983	Saddle Tan	C988	Williamsburgh Green	
C969	Silver	C976	Bar Harbor Gray	C984	Oak Brown	C989	Raven Black	C994
C970	Gold	C977	Newport Blue	C985	Pyro Brown	C993	Kelly Green	C995—French Lilac
C996	Russet	C997	Sable					
C1000	Pompano Beach White	C1001	Moss Point Green	C1002	Mist Gray			
C1020	Silver Foil (1-ply)	C1021	Gold Foil (1-ply)					
C1008	Ivory	C1027	Silver Gray	C1042	Williamsburg Red	C1067	Storm Blue	
C1009	Light Jonquil	C1028	Spice Ivory	C1045	Grass Green	C1073	Biscay Blue	
C1014	Olde Grey	C1029	Wheat	C1047	Williamsburg Blue	C1076	Las Cruces Purple	
C1015	Grey Violet	C1031	Light Teal	C1051	Olde Tan	C1077	Burnt Orange	
C1016	Concord	C1032	Dark Olive	C1053	Delft Blue	C1078	Madagascar Pink	C1085
C1019	Photo Grey	C1033	Dark Ash	C1054	Baltic Blue	C1080	Bimini Blue	C1087
C1023	Crimson	C1038	Maroon	C1056	Boulder Brown	C1081	Volcano Blue	C1088
C1024	Dusty Blue	C1039	Auburn	C1057	Redwood	C1082	Marine Blue	C1089
C1025	Medium Gray	C1040	Classic Brown	C1061	Sandstone	C1084	Avocado	C1090
C1092	Azure	C1095	Antique Buff	C1096	Sepia	C1097	Fudge	
C3214	Chinese Red	C3291	French Buff	C3297	Arctic White			
C3290	Snow White	C3293	Antique White	C3331	Sage			
C3314	Limoge Pink	C3323	Real Teal	C3333	Black Watch			
C3315	Porcelain	C3325	Mandarin	C3342	Midnight Green	C3352	Light Umbria	C3358
C3319	Topaz	C3326	Lapis	C3343	Off White	C3354	Winter White	C3359
C3320	Saffron	C3328	Art Deco Green	C3344	Manor Black	C3357	Aqua Green	C3360
C3380	Hay	C3387	Rattan	C3921	Black & White Pebble			
PAPER MATBOARD • 40x60 Double Thick (6 Ply)						1-24:	25-49:	50+:
C846 White & Cream						25.18	23.91	22.16
REGULAR MATBOARD • 40 x 60 (4 Ply)						1-24:	25-49:	50+:
C81027 Silver Gray						14.39	13.38	11.94
C81028	Spice Ivory	C81090	Pewter	C83300	Alabaster	C8924	Dark Gray	C8974
C81038	Maroon	C81096	Sepia	C83326	Lapis	C8934	Pearl	C8977
C81051	Olde Tan	C831	Smooth Black	C83331	Sage	C8948	Sand	C8978
C81081	Volcano Blue	C83214	Chinese Red	C83344	Manor Black	C8961	Cream	C8983
C81085	Rust	C83291	French Buff	C8900	Red	C8962	French Gray	C8987
C81088	Mist	C83293	Antique White	C8912—India		C8968	Old Gold	C8988
		C83297	Arctic White	C8918	Very White	C8969	Silver	C8989
BLACK CORE MATBOARD • 32 x 40 (4 Ply)						1-24:	25-49:	50+:
C6915 Fog						8.77	8.16	7.28
C6977	Newport Blue	C6989	Raven Black	C61025	Medium Gray	C61032	Dark Olive	C61073
C6984	Oak Brown	C61002	Mist Gray	C61027	Silver Gray	C61033	Dark Ash	C61088
C6988	Williamsburg Green	C61019	Photo Grey	C61028	Spice Ivory	C61038	Maroon	C63297
		C61023	Crimson	C61029	Wheat	C61061	Sandstone	C63300
BLACK CORE MATBOARD • 40 x 60 (4 Ply)						1-24:	25-49:	50+:
C86989 Raven Black						17.82	16.57	14.79
C863297 Arctic White								
SILKI PAPER MATBOARD • 32 x 40 (4 Ply)						1-24:	25-49:	50+:
C4128 Haze Green						11.09	10.31	9.20
C4130	Smoked Pearl	C4131	Oyster White	C4137	Champagne	C4140	White	
PRECIOUS METALS PAPER MATBOARD • 32 x 40 (4 Ply)						1-24:	25-49:	50+:
C3703 Gunmetal						10.97	10.20	9.10
C3712 Rouge Gold								
FLORENTINE METALLICS PAPER MATBOARD • 32 x 40 (4 Ply)						1-24:	25-49:	50+:
C964 Silver						8.90	8.28	7.39
		C965—Red-Gold		C967	Medium Gold			
FLANNEL PAPER MATBOARD • 32 x 40 (4 Ply)						1-24:	25-49:	50+:
C3300 Alabaster						6.63	6.17	5.50
C3307	Devonshire Blue	C3311	Granite	C3346	Moss			

CRESCENT SELECT • 32 x 40 (4 Ply) 1-24: **9.61** 25-49: **8.94** 50+: **7.98**

C5647 Carnation	C9530 Hedge Hog	C9568 Make-Up	C9602 Guacamole	C9806 Dove	C9861 York
C5648 Peony	C9531 Spinach	C9569 Coho	C9603 Underbrush	C9807 Off White	C9862 Sandhurst
C5651 Bluebird	C9532 Olive Branch	C9570 Sushi	C9604 Blarney	C9808 Ivory Art	C9865 Kensington
C5653 Robins Egg	C9533 Bonsai	C9571 Bandage	C9605 Tealy Dan	C9809 Twilight	C9866 Plymouth
C9500 White Glove	C9535 Turf	C9572 Fiji Coral	C9606 Jaws	C9810 Tawny	C9869 Red
C9501 White Collar	C9536 Frond	C9573 Cranberry Sauce	C9607 Blue Chip	C9811 Putty	C9871 Rose Bush
C9502 White Sale	C9537 Envy	C9574 Marooned	C9608 Sweet Tart	C9812 Old Ivory	C9872 Irish Green
C9503 White Hot	C9538 Deep Woods	C9575 Rare	C9610 Code Red	C9813 Sandstone	C9873 Red Light
C9504 White Lie	C9539 Riptide	C9576 Valentine	C9611 Peat Moss	C9814 Autumn Gold	C9874 Red Line
C9505 White Wash	C9542 Blue Monday	C9577 Stop	C9612 Fuzz	C9815 Fawn	C9875 Saffron
C9506 Egg White	C9543 Fathom	C9578 Rusted	C9613 Super White	C9816 Ginger	C9876 Mandarin Orange
C9507 White Elephant	C9544 Chicago Blues	C9579 Mudslide	C9614 Glow	C9818 Sienna	C9877 Midnight Green
C9508 White Sands	C9545 Glacier	C9581 Hot Sauce	C9615 Cream Puff	C9820 Forest Green	C9878 Aqua Green
C9509 Half & Half	C9546 Blue Satin	C9582 Yam I Am	C9616 Honey Wheat	C9822 Sierra Olive	C9879 Purple Iris
C9510 Froth	C9547 In A Fog	C9583 Peanut Butter	C9618 Tater	C9823 Black Forest	C9880 Royal Blue
C9511 Fossil	C9548 Blue Lilac	C9584 Catcher's Mitt	C9621 Bud	C9826 Mocha Green	C9881 Real Teal
C9512 Mummy	C9549 Inlet	C9585 Root Beer	C9623 Greenery	C9827 Flag Blue	C9882 Cornflower
C9513 Sand Trap	C9550 Cabana	C9586 Brown Sugar	C9624 Scrubs	C9828 Mystic Blue	C9884 Napa Valley Red
C9514 Toasty	C9551 Blue Wave	C9587 Milk Chocolate	C9625 Blue Moon	C9830 Blue Night	C9885 Jeans
C9515 Wet Sand	C9552 NYPD	C9588 Milk Shake	C9627 Ink Spot	C9831 Blue Iris	C9886 Dark Purple
C9516 Tusk	C9553 Moody Blue	C9589 Bambi	C9628 Punch	C9832 Stormy Blue	C9887 Black-N-Blue
C9518 Summer	C9554 Pharaoh	C9590 Fresh Brew	C9629 Rhino	C9833 Orange Ade	C9888 Electric Blue
C9519 Curry	C9555 Steel Drum	C9591 Top Soil	C9630 Meteorite	C9834 Russet	C9889 Deep Blue
C9520 Haystack	C9556 Tempest	C9592 Blizzard	C9631 Coal Mine	C9835 Harvest Brown	C9890 Phantom Blue
C9521 Gold Rush	C9557 Pigeon	C9593 Gravel Road	C9632 Black Belt	C9837 All American Red	C9891 Teal Teal
C9522 Oleo	C9558 Geode	C9594 Concrete	C9633 Morning	C9838 Brick	C9892 Deep Orange
C9523 Omelet	C9559 Plink	C9595 Urban	C9634 Cloudburst	C9839 Cabernet	C9893 Blaze Orange
C9524 In The Buff	C9560 Easter Egg	C9596 Cubicle	C9635 Nightfall	C9840 Plum	C9894 Golden
C9525 Sage Advice	C9561 Purple Haze	C9597 Field Mouse	C9800 Baker'S White	C9842 Coffee Bean	C9895 Pewter
C9526 Pickle	C9562 Grape Jelly	C9598 Before Dark	C9801 Chalk	C9846 Dark Shale	C9896 Lawn
C9527 Wise Green	C9564 Purple Mountain	C9599 After Dark	C9802 White Art	C9848 Jet Black	C9897 Water Fall
C9528 Lentil	C9565 Quarry	C9600 Batter	C9804 Pure White	C9859 Cambridge	C9898 Burnt Orange
C9529 Silly Putty	C9567 Cotton Candy	C9601 Sandpaper	C9805 Coconut Milk	C9860 Devonshire	C9899 Red Hot

C5598 Etched Black C9870 Silver Star 1-24: **11.15** 25-49: **10.37** 50+: **9.25**

C9744 Golf Ball 1-24: **16.72** 25-49: **15.55** 50+: **13.88**

CRESCENT SELECT • 40 x 60 (4 Ply) 1-24: **19.78** 25-49: **18.40** 50+: **16.42**

C89500 White Glove	C89527 Wise Green	C89613 Super White	C89809 Twilight	C89832 Stormy Blue	C89862 Sandhurst
C89501 White Collar	C89533 Bonsai	C89614 Glow	C89812 Old Ivory	C89833 Orange Ade	C89865 Kensington
C89502 White Sale	C89542 Blue Monday	C89618 Tater	C89813 Sandstone	C89834 Russet	C89866 Plymouth
C89505 White Wash	C89552 NYPD	C89632 Black Belt	C89814 Autumn Gold	C89835 Harvest Brown	C89869 Red
C89506 Egg White	C89553 Moody Blue	C89633 Morning	C89815 Fawn	C89837 All American Red	C89874 Red Line
C89507 White Elephant	C89554 Pharaoh	C89634 Cloudburst	C89816 Ginger	C89838 Brick	C89876 Mandarin Orange
C89508 White Sands	C89574 Marooned	C89635 Nightfall	C89818 Sienna	C89839 Cabernet	C89877 Midnight Green
C89511 Fossil	C89591 Top Soil	C89800 Baker's White	C89820 Forest Green	C89840 Plum	C89881 Real Teal
C89514 Toasty	C89592 Blizzard	C89801 Chalk	C89822 Sierra Olive	C89846 Dark Shale	C89882 Cornflower
C89516 Tusk	C89598 Before Dark	C89804 Pure White	C89826 Mocha Green	C89848 Jet Black	C89886 Dark Purple
C89518 Summer	C89599 After Dark	C89806 Dove	C89827 Flag Blue	C89859 Cambridge	C89889 Deep Blue
C89520 Haystack	C89601 Sandpaper	C89807 Off White	C89828 Mystic Blue	C89860 Devonshire	C89892 Deep Orange
C89524 In The Buff	C89610 Code Red	C89808 Ivory Art	C89830 Blue Night	C89861 York	C89894 Golden
					C89899 Red Hot

C85598 Etched Black 1-24: **22.78** 25-49: **21.19** 50+: **18.91**

CRESCENT SELECT • 32 x 40 (6 Ply) 1-24: **13.73** 25-49: **12.77** 50+: **11.39**

C29500 White Glove	C29502 White Sale	C29505 White Wash	C29507 White Elephant	C29599 After Dark
--------------------	-------------------	-------------------	-----------------------	-------------------

SELECT ULTIBLACKS • 32 x 40 (4 Ply) 1-24: **12.16** 25-49: **11.31** 50+: **10.09**

C9900 Baker's White	C9905 Dove	C9916 Mocha Green	C9924 Plymouth	C9930 Plum	C9942 Dark Shale
C9901 Chalk	C9906 Off White	C9917 Forest Green	C9926 All-American Red	C9932 Fawn	C9944 Jet Black
C9902 White Art	C9912 Sandstone	C9922 Flag Blue	C9927 Brick	C9934 Putty	C9948 Black Belt
C9904 Pure White	C9914 Ginger	C9923 Blue Night	C9928 Cabernet	C9936 Harvest Brown	

C9931 Devonshire C9935 York C9938 Kensington C9940 Gladstone 1-24: **12.16** 25-49: **11.31** 50+: **10.09**

C5579 Etched Black C9945 Silver C9946 Rose C9947 Spanish Gold 1-24: **14.02** 25-49: **13.04** 50+: **11.64**

C9910 Antwerpen C9911 Bruxelles 1-24: **14.02** 25-49: **13.04** 50+: **11.64**

C69745 Football C69746 Basketball 1-24: **16.72** 25-49: **15.55** 50+: **13.88**

SELECT ULTIBLACKS • 40 x 60 (4 ply)

C89901 Chalk	C89904 Pure White	C89944 Jet Black	C89948 Black Belt	1-24: 25.04	25-49: 23.29	50+: 20.78
C89940 Gladstone				1-24: 25.04	25-49: 23.29	50+: 20.78
C85579 Etched Black				1-24: 29.04	25-49: 27.01	50+: 24.10

CRESCENT SELECT CONSERVATION SOLIDS • 32 x 40 (4 ply)

C5700 Vivid White	C5702 White	C5704 Cream	C5706 Tan	C5712 Cloud Gray	1-24: 13.64	25-49: 12.69	50+: 11.32
C5701 Arctic White	C5703 Antique White	C5705 Buff	C5707 Sand	C5713 Neutral Gray			
C5708 Dark Brown	C5710 Dark Gray	C5714 Classic Gray					
C5709 Gray	C5711 Deep Black						

CRESCENT SELECT CONSERVATION SOLIDS • 40 x 60 (4 ply)

C85700 Vivid White	C85702 White	C85703 Antique White	C85704 Cream	C85706 Tan	C85712 Cloud Gray	C85713 Neutral Gray	1-24: 24.16	25-49: 22.47	50+: 20.05
C85711 Deep Black	C85714 Classic Gray								

CRESCENT SELECT CONSERVATION SOLIDS • 32 x 40 (8 ply)

C25700 Vivid White	C25702 White	C25703 Antique White	C25704 Cream	C25706 Tan	C25712 Cloud Gray	1-24: 21.21	25-49: 19.73	50+: 17.60
C25711 Deep Black								

CRESCENT SELECT CONSERVATION SOLIDS • 40 x 60 (8 ply)

C825700 Vivid White	C825702 White	C825703 Antique White	C825704 Cream	C825706 Tan	C825712 Cloud Gray	1-24: 43.59	25-49: 40.54	50+: 36.18
C825711 Deep Black								

ACCENTS • 32 x 40 (4 ply)

C9723 Bronze Plated	C9724 Silver Plated	C9725 Aztec	C9726 Outback	1-24: 14.48	25-49: 13.47	50+: 12.02
C9727 Gaucho	C9728 Safari	C9729 Pueblo	C9735 Denali			
C9736 Sand Dune	C9737 Gobi	C9738 Tundra	C9739 Mesa			

SELECT SUEDES • 32 x 40 (4 ply)

C5500 Treeline	C5503 Berry	C5507 Graphite	C5510 Red Sky	C5515 Thicket	C5637 Leaf	1-24: 27.44	25-49: 25.52	50+: 22.77
C5501 Brook	C5505 Firelight	C5508 Cocoa	C5511 Light Gray	C5633 White	C5638 Tile Blue			
C5502 Torrent	C5506 Night Sky	C5509 Sunrise	C5512 Clementine	C5636 Purple Torch	C5639 Twig			

SELECT SUEDES • 40 x 60 (4 ply)

C85500 Treeline	C85502 Torrent	C85506 Night Sky	C85510 Red Sky	C85636 Purple Torch	1-24: 48.10	25-49: 44.73	50+: 39.92
C85501 Brook	C85503 Berry	C85508 Cocoa	C85633 White	C85638 Tile Blue			

CLASSIC LINENS • 32 x 40 (4 ply)

C5520 Classic Beige	C5522 Navy Blue	C5527 Deep Red	C5532 Vintage Green	C5534 Classic Burgundy	C5538 Cayenne	1-24: 24.55	25-49: 22.83	50+: 20.38
C5521 Noir	C5526 English Taupe	C5531 Dark Olive	C5533 Vintage White	C5537 Chestnut				

CLASSIC LINENS • 40 x 60 (4 ply)

C85520 Classic Beige	C85521 Noir	C85533 Vintage White	1-24: 53.04	25-49: 49.33	50+: 44.02
----------------------	-------------	----------------------	--------------------	---------------------	-------------------

SELECT NATURAL SILKS • 32 x 40 (4 ply)

C5549 Cream	C5551 Light Khaki	C5554 Truffle	C5556 Honey Brown	C5559 British Tan	C5561 Sahara Sand	1-24: 31.00	25-49: 28.83	50+: 25.73
C5550 Antique White	C5552 Clover	C5555 Black Kimono	C5557 Tuscan Brown	C5560 Black Shadow				

VINTAGE LINENS • 32 x 40 (4 ply)

C5558 Vintage Yellow	C5559 British Tan	C5560 Black Shadow	C5561 Sahara Sand	C5632 Warm White	1-24: 33.41	25-49: 31.07	50+: 27.73
----------------------	-------------------	--------------------	-------------------	------------------	--------------------	---------------------	-------------------

SELECT JUTES • 32 x 40 (4 ply)

C5539 Cream	C5540 Barnwood	C5541 Navy	C5542 Black	C5543 Barn Red	C5654 Natural	1-24: 33.41	25-49: 31.07	50+: 27.73
-------------	----------------	------------	-------------	----------------	---------------	--------------------	---------------------	-------------------

SELECT JUTES • 40 x 60 (4 ply)

C85539 Cream	C85540 Barnwood	C85542 Black	C85654 Natural	1-24: 62.63	25-49: 58.25	50+: 51.98
--------------	-----------------	--------------	----------------	--------------------	---------------------	-------------------

SHIMMER LINENS • 32 x 40 (4 ply)

C5660 White Shimmer	C5661 Ivory Shimmer	C5851 Golden Shimmer	C5852 Silver Shimmer	C5853 Ebony Shimmer	1-24: 27.67	25-49: 25.73	50+: 22.96
---------------------	---------------------	----------------------	----------------------	---------------------	--------------------	---------------------	-------------------

SHIMMER LINENS • 40 x 60 (4 ply)

C85660 White Shimmer	C85661 Ivory Shimmer	C85853 Ebony Shimmer	1-24: 58.71	25-49: 54.60	50+: 48.73
----------------------	----------------------	----------------------	--------------------	---------------------	-------------------

LUSTER PARCHMENTS • 32 x 40 (4 ply)

C5862 Pewter Parchment	C5863 Gold Parchment	C5864 Silver Parchment	C5865 Snow Parchment	C5866 Ivory Parchment	C5867 Bronze Parchment	1-24: 24.55	25-49: 22.83	50+: 20.38
------------------------	----------------------	------------------------	----------------------	-----------------------	-----------------------------------	--------------------	---------------------	-------------------

SELECT BOUCLE • 32 x 40 (4 ply)

C9863 Brittany	1-24: 11.15	25-49: 10.37	50+: 9.25
----------------	--------------------	---------------------	------------------

SELECT BOUCLE • 40 x 60 (4 ply)

C89863 Brittany	1-24: 22.78	25-49: 21.19	50+: 18.91
-----------------	--------------------	---------------------	-------------------



• All prices shown are per sheet.

SELECT FLANNELS • 32 x 40 (4 Ply)				1-24: 9.61	25-49: 8.94	50+: 7.98
C9859 Cambridge	C9861 York	C9865 Kensington	C9869 Red			
C9860 Devonshire	C9862 Sandhurst	C9866 Plymouth				
SELECT FLANNELS • 40 x 60 (4 Ply)				1-24: 19.78	25-49: 18.40	50+: 16.42
C89859 Cambridge	C89861 York	C89865 Kensington				
C89860 Devonshire	C89862 Sandhurst	C89866 Plymouth				
SELECT FLORENTINES • 32 x 40 (4 Ply)				1-24: 11.15	25-49: 10.37	50+: 9.25
C9850 Silver	C9852 Gold	C9855 Spanish Gold				
C9851 Gold Nugget	C9854 Rose	C9856 Sun				
SELECT FLORENTINES • 40 x 60 (4 Ply)				1-24: 22.78	25-49: 21.19	50+: 18.91
C89850 Silver	C89851 Gold Nugget	C89854 Rose	C89855 Spanish Gold	C89856 Sun		
SELECT BELGIQUES • 32 x 40 (4 Ply)				1-24: 11.15	25-49: 10.37	50+: 9.25
C9849 Antwerpen	C9853 Bruxelles					
SELECT ULTIBLACK BELGIQUES • 32 x 40 (4 Ply)				1-24: 14.02	25-49: 13.04	50+: 11.64
C9910 Antwerpen	C9911 Bruxelles					
SELECT BELGIQUES • 40 x 60 (4 Ply)				1-24: 22.78	25-49: 21.19	50+: 18.91
C89849 Antwerpen	C89853 Bruxelles					
SELECT METALLICS • 40 x 60 (4 Ply)				1-24: 22.78	25-49: 21.19	50+: 18.91
C89521 Gold Rush	C89870 Silver Star					
MOORMAN SUEDES • 32 x 40 (4 Ply) High quality sueded fabric on white acid free core.				1-24: 33.64	25-49: 31.29	50+: 27.92
C7100 Moutarde	C7114 Carbon Black	C7136 Le Beige	C7159 Cottage Stone	C7181 Sunset	C7193 Tumbleweed	
C7101 Perle	C7115 Moka	C7138 Pink	C7160 Ember	C7182 Bronze	C7194 Garnet	
C7102 Dune	C7116 Chinese Red	C7139 Anthracite	C7162 Reed	C7183 Moccasin	C7195 Sapphire	
C7104 Chamois	C7120 Polaris	C7140 Weesp Blue	C7163 Rattan	C7184 Cinnamon	C7196 Teal	
C7105 Dark Rust	C7127 Milkweed	C7141 Platinum	C7164 Meadow	C7185 Chambord	C7199 Spruce	
C7106 Antelope	C7128 Off White	C7154 Marigold	C7165 Evergreen	C7186 French Lavender		
C7109 Taupe	C7132 Whisper	C7155 Wildgrass	C7166 Navy	C7187 Celestial		
C7111 Shamrock Green	C7133 Dusty Green	C7156 Summer Sky	C7167 Boulder	C7188 Mercury		
C7112 Bordeaux	C7134 Asparagus	C7157 Cattail	C7168 Graphite	C7190 Olive		
C7113 Marine Blue	C7135 Pine Green	C7158 Storm Gray	C7180 White	C7191 Pfalzgraff		
MOORMAN SUEDES • 40 x 60 (4 Ply)				1-24: 59.00	25-49: 54.87	50+: 48.97
C87100 Moutarde	C87111 Shamrock Green	C87127 Milkweed	C87139 Anthracite	C87166 Navy	C87188 Mercury	
C87101 Perle	C87112 Bordeaux	C87128 Off White	C87141 Platinum	C87168 Graphite	C87190 Olive	
C87102 Dune	C87113 Marine Blue	C87132 Whisper	C87155 Wildgrass	C87180 White	C87191 Pfalzgraff	
C87104 Chamois	C87114 Carbon Black	C87133 Dusty Green	C87157 Cattail	C87182 Bronze	C87193 Tumbleweed	
C87105 Dark Rust	C87115 Moka	C87134 Asparagus	C87158 Storm Gray	C87183 Moccasin	C87195 Sapphire	
C87106 Antelope	C87116 Chinese Red	C87135 Pine Green	C87163 Rattan	C87184 Cinnamon	C87199 Spruce	
C87109 Taupe	C87120 Polaris	C87136 Le Beige	C87164 Meadow	C87185 Chambord		
MOORMAN BLACK CORE SUEDES • 32 x 40 (4 Ply)				1-24: 33.64	25-49: 31.29	50+: 27.92
C67101 Perle	C67106 Antelope	C67112 Bordeaux	C67114 Carbon Black			
C67102 Dune	C67111 Shamrock Green	C67113 Marine Blue	C67139 Anthracite			
MOORMAN LINENS • 32 x 40 (4 Ply)				1-24: 29.00	25-49: 26.97	50+: 24.07
C7501 Vink Tweed	C7522 Black	C7540 Light Beige	C7551 Flax	C7565 Vintage Ruby	C7580 Burgundy	
C7513 Forest Green	C7526 Cream	C7541 Silver Gray	C7553 Edelweiss	C7566 Amethyst Linen	C7581 Jewel Blue	
C7517 Dark Rose	C7529 Medium Brown	C7542 Red Carpet	C7554 North Sea	C7567 Ultramarine Blue	C7582 Lotus	
C7518 Royal Blue	C7531 Light Gray	C7543 Dark Mauve	C7556 Dutch Chocolate	C7569 Loden Green	C7583 Scroll	
C7519 White	C7533 Medium Blue	C7548 Tru Blue	C7557 Topiary	C7571 Delft Brown	C7584 Havana	
C7520 Medium Gray	C7536 Blue Green	C7549 Jasper Brown	C7560 Basque	C7572 Worn Gray	C7586 Sumi	
C7521 Blue Gray	C7537 Light Moss	C7550 Smokey Hill	C7564 Maroon	C7573 Brindle Brown	C7588 Khaki	
					C7597 Off White	
MOORMAN NATURAL LINENS • 32 x 40 (4 Ply)				1-24: 39.59	25-49: 36.82	50+: 32.86
C7700 Warm White	C7702 Parchment	C7704 Lagoon	C7706 Harvest			
C7701 Canvas	C7703 Willow	C7705 Stone	C7707 Midnight			



• All prices shown are per sheet.

MOORMAN LINENS • 40 x 60 (4 Ply) 1-24: **57.30** 25-49: **53.29** 50+: **47.56**

C87501 Vink Tweed	C87526 Cream	C87548 Tru Blue	C87554 North Sea	C87569 Loden Green	C87581 Jewel Blue
C87513 Forest Green	C87529 Medium Brown	C87549 Jasper Brown	C87556 Dutch Chocolate	C87571 Delft Brown	C87582 Lotus
C87518 Royal Blue	C87540 Light Beige	C87550 Smokey Hill	C87557 Topiary	C87572 Worn Gray	C87586 Sumi
C87519 White	C87541 Silver Gray	C87551 Flax	C87560 Basque	C87573 Brindle Brown	C87597 Off White
C87522 Black	C87542 Red Carpet	C87553 Edelweiss	C87564 Maroon	C87580 Burgundy	

MOORMAN NATURAL LINENS • 40 x 60 (4 Ply) 1-24: **95.84** 25-49: **89.13** 50+: **79.55**

C87700 Warm White	C87705 Stone	C87706 Harvest	C87707 Midnight
-------------------	--------------	----------------	-----------------

MOORMAN SHEER SILKS • 32 x 40 (4 Ply) 1-24: **36.02** 25-49: **33.50** 50+: **29.90**

C7800 White	C7803 Tan	C7806 Moss	C7809 Blue	C7812 Brown
C7801 Antique White	C7804 Khaki	C7807 Olive	C7810 Maroon	C7813 Deep Brown
C7802 Cream	C7805 Sage	C7808 Green	C7811 Red	C7815 Black

MOORMAN SHEER SILKS • 40 x 60 (4 Ply) 1-24: **71.21** 25-49: **66.23** 50+: **59.13**

C87800 White	C87803 Tan	C87809 Blue	C87813 Deep Brown
C87801 Antique White	C87808 Green	C87811 Maroon	C87815 Black

MOORMAN LEATHER • 32 x 40 (4 Ply) 1-24: **44.66** 25-49: **41.53** 50+: **37.07**

Black acid free core

C67300 Black Leather	C67307 Van Dyke	C67308 Cordovan	C67309 Tuscan Wine
----------------------	-----------------	-----------------	--------------------

BRITE CORE MATBOARD • 32 x 40 (4 Ply) Duplex surface color core matboards 1-24: **27.23** 25-49: **25.32** 50+: **22.60**

CBR14921 Blue On Black	CBR34921 Red On Black	CBR54921 Orange On Black	CBR74921 Black On Pink
CBR14987 Blue On White	CBR34987 White On Red	CBR54987 Orange On White	CBR74987 White On Pink
CBR24921 Green On Black	CBR44921 Yellow On Black	CBR64921 Purple On Black	CBR84921 Black On Aqua
CBR24987 Green On White	CBR44987 Yellow On White	CBR64987 Purple On White	CBR84987 White On Aqua

INTERNATIONAL WHITE CORE BASICS • 32 x 40 (4 Ply) 1-24: **7.01** 25-49: **6.52** 50+: **5.82**

CSRM1000 Pompano Bch White	CSRM1040 Classic Brown	CSRM1096 Sepia	CSRM3370 Cornflower	CSRM3420 All American Red	CSRM972 French Blue
CSRM1001 Moss Point Green	CSRM1042 Williamsburg Red	CSRM3214 Chinese Red	CSRM3372 Black Currant	CSRM3421 Spice	CSRM976 Bar Harbor Gray
CSRM1008 Ivory	CSRM1045 Grass Green	CSRM3290 Snow White	CSRM3400 Baker'S White	CSRM3422 Volcano Fire	CSRM977 Newport Blue
CSRM1014 Olde Grey	CSRM1047 Williamsburg Blue	CSRM3291 French Buff	CSRM3401 Chalk	CSRM3423 Jet Black	CSRM978 Congo Green
CSRM1015 Grey Violet	CSRM1051 Olde Tan	CSRM3293 Antique White	CSRM3403 Dove	CSRM3425 York	CSRM979 Dusk
CSRM1016 Concord	CSRM1053 Delft Blue	CSRM3297 Arctic White	CSRM3404 Bone	CSRM902 Yellow	CSRM984 Oak Brown
CSRM1019 Photo Grey	CSRM1054 Baltic Blue	CSRM3300 Alabaster	CSRM3406 Tawny	CSRM915 Fog	CSRM985 Pyro Brown
CSRM1023 Crimson	CSRM1057 Redwood	CSRM3319 Topaz	CSRM3407 Putty	CSRM918 Very White	CSRM986 Tampico Brown
CSRM1025 Medium Gray	CSRM1073 Biscay Blue	CSRM3325 Mandarin	CSRM3409 Fawn	CSRM919 Ivy Green	CSRM987 Palm Beach White
CSRM1027 Silver Gray	CSRM1076 Las Cruces Purple	CSRM3326 Lapis	CSRM3410 Ginger	CSRM921 Smooth Black	CSRM988 Williamsburg Green
CSRM1028 Spice Ivory	CSRM1081 Volcano Blue	CSRM3331 Sage	CSRM3412 Mocha Green	CSRM924 Dark Gray	CSRM989 Raven Black
CSRM1029 Wheat	CSRM1082 Marine Blue	CSRM3333 Black Watch	CSRM3413 Forest Green	CSRM934 Pearl	CSRM994 Chamois Gold
CSRM1032 Dark Olive	CSRM1084 Avocado	CSRM3364 Green Apple	CSRM3414 Sierra Olive	CSRM939 Dark Green	CSRM997 Sable
CSRM1038 Maroon	CSRM1088 Mist	CSRM3368 Sunset Clay	CSRM3417 Flag Blue	CSRM948 Sand	
CSRM1039 Auburn	CSRM1089 Sauterne	CSRM3369 Sheer Blue	CSRM3418 Cabernet	CSRM961 Cream	

CSRM968 Old Gold CSRM969 Silver 1-24: **8.63** 25-49: **8.03** 50+: **7.16**

INTERNATIONAL WHITE CORE BASICS • 40 x 60 (4 Ply) 1-24: **15.15** 25-49: **14.09** 50+: **12.57**

CSRM8921 Smooth Black	SRM81088 Mist	SRM83293 Antique White	CSRM8987 Palm Beach White	SRM83403 Dove	SRM83417 Flag Blue
CSRM8988 Williamsburg Green	SRM81027 Silver Gray	CSRM8977 Newport Blue	SRM83400 Baker's White	SRM83404 Bone	SRM83420 All-American Red
CSRM8989 Raven Black	SRM81028 Spice Ivory	SRM83297 Arctic White	SRM83401 Chalk	SRM83411 Green Mist	SRM83423 Jet Black

CSRM8968 Old Gold 1-24: **19.41** 25-49: **18.05** 50+: **16.11**

1-24: **19.41** 25-49: **18.05** 50+: **16.11**

FAUX MARBLE (INTERNATIONAL WHITE CORE) • 32 x 40 (4 Ply) 1-24: **8.63** 25-49: **8.03** 50+: **7.16**

C4400 Light Gray	C4404 Black
------------------	-------------

FAUX MARBLE METALLIC (INTERNATIONAL WHITE CORE) • 32 x 40 (4 Ply) 1-24: **8.98** 25-49: **8.35** 50+: **7.45**

C4444 Black Gold

CLASSICS (INTERNATIONAL WHITE CORE) • 32 x 40 (4 Ply) 1-24: **8.63** 25-49: **8.03** 50+: **7.16**

Faux Leather					
CSRM3426 Rawhide	CSRM3427 Buckskin	CSRM3428 New Stetson	CSRM3429 Saddle	CSRM3430 Chaps	

Library Leather 1-24: **8.63** 25-49: **8.03** 50+: **7.16**

CSRM3431 Chaucer Brown	CSRM3433 Hawthorne Red	CSRM3435 Kerouac Black
CSRM3432 Longfellow Green	CSRM3434 Hemingway Blue	

Belgiques 1-24: **8.63** 25-49: **8.03** 50+: **7.16**

CSRM3437 Antwerpen	CSRM3438 Bruxelles
--------------------	--------------------



• All prices shown are per sheet.

CRESCENT RAG MATS • 32 x 40 (4 ply)

1-24: 14.77

25-49: 13.74

50+: 12.26

C1420 Cloud	C1548 Ashen	C1577 Raven Black	C1612 True Red	C1646 Sky Blue	C1678 French Jonquil
C1421 Satin	C1550 Newport Blue	C1578 Williamsburg Blue	C1613 Very White	C1647 Patriot Blue	C1679 Wild Basil
C1423 Cloth	C1551 Storm Blue	C1582 Antique Buff	C1616 New Clay	C1648 Ultramarine	C1680 Micro Mint
C1427 Chive	C1552 Biscay Blue	C1583 Olde Tan	C1618 Pottery	C1649 Naples Yellow	C1681 Celery Seed
C1429 Lake	C1553 Bar Harbor Gray	C1584 Nutmeg	C1619 Topaz	C1650 Warm White	C1682 Clearwater
C1431 Ink Blue	C1554 Williamsburg Green	C1586 Light Mauve	C1624 Periwinkle Blue	C1651 Flaxen	C1683 Sauterne
C1433 Shade	C1555 Avocado	C1588 Ivory	C1625 Crimson	C1652 Auburn	C1684 Optic White
C1512 Tuscany Blue	C1558 Russet	C1592 Ocean Mist	C1626 Lapis	C1653 Maroon	C1685 Moonlight
C1513 Calypso Blue	C1559 Redwood	C1593 Sea Shell	C1627 Cerise	C1654 Laurel Green	C1686 Cotton White
C1514 Royal Orchid	C1560 Rust	C1594 Olde Grey	C1629 Taos	C1656 Country Blue	C1687 Eiderdown
C1516 Serengeti	C1561 Sepia	C1595 Grey Violet	C1631 Sage	C1659 Blue Belle	C1688 Whisper White
C1517 Ra	C1562 Sable	C1597 Silver Leaf	C1632 Tea Rose	C1660 Imperial Blue	C1689 Sandstorm
C1518 Wasabi	C1563 Tampico Brown	C1599 Dusty Blue	C1633 Black Watch	C1661 Majestic Purple	C1690 Olive Bronze
C1519 Gecko	C1564 Oak Brown	C1600 Medium Gray	C1634 Fog	C1662 Espresso	C1691 Filbert
C1521 Amazon	C1565 Suntan	C1601 Rose Gray	C1636 Alabaster	C1663 Chamois Gold	C1692 Cashew
C1522 Grecian Olive	C1566 Sandstone	C1602 Silver Gray	C1637 English Stone	C1664 Script White	C1693 Sherwood Green
C1523 Outback Haze	C1567 Sand	C1603 Spice Ivory	C1638 Tapestry	C1665 Barely Blue	C1768 Old Gold
C1524 Bali Sand	C1570 French Buff	C1604 Wheat	C1639 Amethyst	C1666 Sheer Blue	
C1525 Moroccan Spice	C1571 Palm Beach White	C1605 Pastel Pink	C1640 Purple Wildflower	C1668 River Rock	
C1526 Tandoori	C1572 Mist	C1606 Off White	C1641 Malachite	C1670 French Lilac	
C1528 Napa Wine	C1573 Pearl	C1607 Brite White	C1642 Aruba	C1672 Barely Pink	
C1545 Light Umbria	C1574 Dawn Gray	C1608 Cream	C1643 Garnet	C1673 Really Red	
C1546 Dark Olive	C1575 Copley Gray	C1609 Antique White	C1644 Azalea	C1674 Venetian Red	
C1547 Brighton	C1576 Dark Gray	C1610 White	C1645 Cherub Pink	C1675 Sunset Clay	

CRESCENT RAG MATS • 40 x 60 (4 ply)

1-24: 30.57

25-49: 28.43

50+: 25.37

C81420 Cloud	C81577 Raven Black	C81607 Brite White	C81626 Lapis	C81687 Eiderdown
C81516 Serengeti	C81578 Williamsburg Blue	C81608 Cream	C81631 Sage	C81688 Whisper White
C81550 Newport Blue	C81583 Olde Tan	C81609 Antique White	C81633 Black Watch	C81689 Sandstorm
C81554 Williamsburg Green	C81584 Nutmeg	C81610 White	C81647 Patriot Blue	
C81562 Sable	C81588 Ivory	C81612 True Red	C81653 Maroon	
C81571 Palm Beach White	C81602 Silver Gray	C81613 Very White	C81655 Alpine Green	
C81572 Mist	C81603 Spice Ivory	C81619 Topaz	C81664 Script White	
C81576 Dark Gray	C81606 Off White	C81625 Crimson	C81686 Cotton White	

CRESCENT ANTIQUARIAN RAG MATS • 32 x 40 (4 ply Cream Rag Core)

1-24: 16.65

25-49: 15.48

50+: 13.82

C1702 Moss	C1706 Rubia	C1711 Black Walnut	C1716 Brittany	C1723 Lapis
C1703 Foxhunt Green	C1708 Hazelnut	C1713 Stonehenge	C1718 Grayling	
C1704 Ashen	C1709 Light Umbria	C1714 Flaxen	C1721 Black	
C1705 Antique Ivory	C1710 Dark Umbria	C1715 Antique Lace	C1722 Dark Olive	

CRESCENT RAG MAT NOIR • 32 x 40 (4 ply Black Rag Core)

1-24: 21.30

25-49: 19.81

50+: 17.68

C61553 Bar Harbor Gray	C61603 Spice Ivory	C61684 Optic White	C61704 Ashen
C61571 Palm Beach White	C61610 White	C61689 Sandstorm	
C61574 Dawn Gray	C61662 Espresso	C61690 Olive Bronze	

MICHAEL GRAVES COLLECTION • 32 x 40 (4 ply)

1-24: 27.17

25-49: 25.27

50+: 22.55

C1400 White Gold	C1401 Gold	C1402 Copper	C1403 Silver	C1404 Graphite
-----------------------------	------------	--------------	--------------	----------------



• All prices shown are per sheet.

CRESCENT RAG MAT MUSEUM SOLIDS • 32 x 40

C1100 Archival Mist	C1105 Desert Sand	C1117 Gray	C1125 Shetland	C1133 Briar	C1174 Beige
C1101 Neutral Gray	C1106 Antique Gray	C1120 Brighton	C1127 Sprout	C1134 Bramble	C1175 Clay
C1102 Vintage Gray	C1108 Dark Cream	C1121 Inverness	C1128 Shoreline	C1173 Soft Cream	C1176 Suntan
C1104 Antique Tan	C1114 Almond	C1122 Stratford	C1129 Bluff		
C1112 Soft White	C1126 Sand Dollar	C1170 Cool White	C1171 Silk	1-24: 17.18	25-49: 15.98
					50+: 14.26
C1115 Black	C1136 Loam	C1178 Fern		1-24: 22.19	25-49: 20.64
C1123 New Castle	C1137 Fieldstone	C1179 Williamsburg Green			50+: 18.42
C1135 Hedge	C1177 Brownstone	C1184 Sable			
C2255 Cream	C2297 Unbuffered Cream			1-24: 17.18	25-49: 15.98
					50+: 14.26
C2296 Unbuffered Optic Black				1-24: 22.19	25-49: 20.64
					50+: 18.42
C2253 White	C2259 Antique White	C2298 Unbuffered Antique White	C2299 Unbuffered White	1-24: 16.25	25-49: 15.11
					50+: 13.49

6 PLY					
C1536 White				1-24: 27.40	25-49: 25.48
					50+: 22.74

8 PLY					
C21112 Soft White	C21126 Sand Dollar	C2238 White	C2239 Antique White	1-24: 36.40	25-49: 33.85
					50+: 30.21
C21104 Antique Tan	C21106 Antique Gray	C22255 Cream		1-24: 38.17	25-49: 35.50
					50+: 31.38
C21115 Black				1-24: 50.97	25-49: 47.40
					50+: 42.30

CRESCENT RAG MAT MUSEUM SOLIDS • 40 x 60

C2260 Antique White	C81104 Antique Tan	C81106 Antique Gray	C81126 Sand Dollar	1-24: 31.29	25-49: 29.10
C2262 White	C81105 Desert Sand	C81112 Soft White			50+: 25.97
C2261 Cream	C81114 Almond	C81173 Soft Cream	C81121 Inverness	1-24: 33.06	25-49: 30.75
					50+: 27.44
C81115 Black				1-24: 51.84	25-49: 48.21
					50+: 43.03
8 PLY					
C821112 Soft White	C82239 Antique White	C2268 White		1-24: 72.22	25-49: 67.16
					50+: 59.94
C821115 Black				1-24: 106.98	25-49: 99.49
					50+: 88.79

CRESCENT RAG MAT MUSEUM SOLIDS

1 PLY Museum Barrier Paper 32 x 40					
C1515 Off White (.015 Thick)				1-24: 3.72	25-49: 3.46
					50+: 3.09
2 PLY Rag Museum Boards 32 x 40					
C1150 White	C1152 Cream	C1157 Antique White		1-24: 7.09	25-49: 6.59
					50+: 5.88
2 PLY Rag Museum Boards 40 x 60					
C81150 White				1-24: 15.59	25-49: 14.50
					50+: 13.71
4 PLY Duplex Museum Boards 32 x 40 (different color on each side)					
C1530 Antique White/White		C1531 Off White/Cream		1-24: 13.87	25-49: 12.90
					50+: 11.51
4 PLY Rag Museum Boards 32 x 40					
C1153 White	C1155 Cream	C1159 Antique White		1-24: 12.31	25-49: 11.45
					50+: 10.22
4 PLY Rag Museum Boards 40 x 60					
C1161 Cream	C1162 White			1-24: 26.05	25-49: 24.23
					50+: 21.62
4 PLY Rag Museum Boards 48 x 60					
C1163 White	C1169 Antique White			1-24: 39.81	25-49: 33.83
					50+: 30.30

CRESCENT RAG MAT MUSEUM SOLIDS • (Oversized)

C2263 White 48 x 72				1-24: 62.78	25-49: 55.97
					50+: 51.66
C2273 White 48 x 96	C2279 Antique White 48 x 96			1-24: 77.88	25-49: 71.78
					50+: 66.26
C2275 Black 48 x 96				1-24: 92.64	25-49: 87.32
					50+: 80.60
C2283 White 60 x 104	C2289 Antique White 60 x 104			1-4: 111.04	Box (qty. 5): 89.22



CORDED SILKS • 32 x 40 (4 Ply)				1-24: 31.00	25-49: 28.83	50+: 25.73
C5859 Crystal	C5860 Sandcastle	C5861 Amber				
CORDED SILKS • 40 x 60 (4 Ply)				1-24: 65.75	25-49: 61.15	50+: 54.57
C85859 Crystal	C85860 Sandcastle	C85861 Amber				
GOSSAMER SILKS • 32 x 40 (4 Ply)				1-24: 27.67	25-49: 25.73	50+: 22.96
C5854 Coffee	C5855 Raffia	C5856 Glacier Gray	C5857 Peppercorn	C5858 Dusty Plum		
GOSSAMER SILKS • 40 x 60 (4 Ply)				1-24: 58.71	25-49: 54.60	50+: 48.73
C85854 Coffee	C85855 Raffia	C85857 Peppercorn				
SHIMMER WOVENS • 32 x 40 (4 Ply) • New!				1-24: 67.32	25-49: 62.61	50+: 55.87
C7310 Icicle	C7311 Golden Moon	C7312 Mint Julep	C7313 Praline	C7314 Stardust	C7315 Blue Galaxy	
CRESCENT COUTURE • 32 x 40 • New!				Sheet Price: 99.73		
C1300 Spun Tungsten	C1301 Spun Platinum	C1302 Silver Jute	C1303 Black Lacquer	C1304 Gray Pebbles	C1305 Black Pebbles	
CRESCENT COUTURE • 32 x 40 • New!				Sheet Price: 165.88		
C1306 Molten Gold	C1308 Urban Gray	C1309 Silver Birch	C1310 Aged Copper	C1311 Mahogany Leather	C1312 Russet Leather	
CRESCENT COUTURE • 32 x 40 • New!				Sheet Price: 212.08		
C1313 Silver Leaf	C1314 Gold Leaf					

Decorative Mounting Boards

A complete range of foam and mounting boards for any non-conservation mounting need. Crescent decorative mounting boards are warp resistant, cut easily and come in a full range of sizes and thicknesses. Perfect for all general mounting and display purposes.

Conservation Mounting Boards

When long-term protection of art is necessary, use Crescent's line of conservation quality mounting boards. Designed to meet all conservation standards for mat and mounting boards as set by F.A.C.T.S. and F.A.T.G., Crescent acid-free conservation mounting boards are warp resistant, cut easily and come in a full range of sizes and thicknesses.

• All prices shown are per sheet.

CRESCENT ACID FREE MOUNTING BOARDS • 32 x 40

Acid free pulp core & surface papers

CAFX Acid Free X Board (0.50 Thick)	1-24: 3.59	25-49: 3.34	50+: 2.98
CAF3X Acid Free 3X Board (0.90 Thick)	1-24: 6.55	25-49: 6.09	50+: 5.44

CRESCENT WHITE MOUNTING BOARDS

CX.9 "X" Mounting Board (0.48 Thick) 28x44	1-24: 3.48	25-49: 3.23	50+: 3.05
CX.12 "X" Mounting Board (0.48 Thick) 32x40	1-24: 3.50	25-49: 3.25	50+: 2.90
C3X.12 "3X" Mounting Board (0.90 Thick) 32x40	1-24: 6.49	25-49: 6.12	50+: 5.80

CRESCENT WHITE MOUNTING BOARDS • 40 x 60

CS "S" Mounting Board (0.48 Thick)	1-24: 5.99	25-49: 5.57	50+: 4.97
CO "O" Mounting Board (0.90 Thick)	1-24: 10.80	25-49: 10.04	50+: 8.97

CRESCENT ULTRABLACK MOUNTING BOARD • 32 x 40

C8 UltraBlack 8 Solid Black Double Sided mount board	1-24: 6.56	25-49: 6.11	50+: 5.78
--	-------------------	--------------------	------------------

CRESCENT PERFECT MOUNT ACID FREE CORE & PAPER SHADE • 32 x 40

CPSX PSX Perfect Mount ST (.050-.055)	1-24: 13.65	25-49: 12.69	50+: 11.33
CPS3X PS3X Perfect Mount DT (.085-.090)	1-24: 17.66	25-49: 16.42	50+: 14.66
CPSFC PSFC Perfect Mount Sheets 3/16" Foam Center	1-24: 17.64	25-49: 16.40	50+: 15.53

CRESCENT ILLUSTRATION BOARDS

C300 30x40 Cold Press Illustration Board (.05-.06) Medium Weight	Sheet Price: 8.88
C110.6 20x30 Cold Press Illustration Board (.085-.095) Heavy Weight	Sheet Price: 10.01

CRESCENT PRESENTATION BOARDS

C601 14-ply Poster Board 28x44 Satin White	1-24: 3.88	25-49: 3.66	50+: 3.30
C11W Needleart Mount Board 32x40 (.188 triple-thick white)	1-24: 9.58	25-49: 8.91	50+: 7.95
CPBFC Black Perfect Mount Foam Board (3/16") 32x40	1-24: 25.53	25-49: 23.74	50+: 22.43

Bainbridge®

Nielsen Bainbridge's innovation drives the industry. In 1979, Nielsen Bainbridge introduced Alphamat - the first museum quality board with colored surfaces - designed to meet both the creative and conservation needs. In 1995, Nielsen Bainbridge introduced patented Artcare technology - the first and only mat and mount boards that actively protect artwork from the damaging effects of air pollution and acids generated by the artwork itself. The Artcare technology completely redefines the function of museum quality products.

Bainbridge Paper Mats

Bainbridge® Papermat combines exceptional quality with a wide selection of colors to appeal to every taste. Buffered to an alkaline pH, Bainbridge papermat provides consistent colors, clean, creamy bevels and smooth cuts.

Artcare by Bainbridge

Artcare products, featuring the patented MicroChamber technology, provide a preventative conservation protection unavailable with any other rag board. A unique combination of zeolites and buffers traps and neutralizes oxidizing gases, other pre-acidic gases, and degradative by-products giving Artcare boards the ability to actively protect art and photographs against attack by external pollutants and internal vices. Made from the purest cotton rag pulp and subject to rigorous quality control, Alphasag Artcare meets or exceeds all industry standards for paper permanence. Plus, Artcare sets a new standard for preventative protection that is unique in the field of art conservation

Alphamat Artcare

Alphamat Artcare offers the most extensive selection of museum-quality preservation boards available today. Featuring the latest colours and a solid white archival core for clean, consistent bevels, Alphamat is fade and bleed resistant with colour consistency for colours that stay true for the life of your art.

Archival White Core - Specially formulated, solid white archival, lignin-free core, for clean, consistent bevels and unmatched cut quality.

Artcare Archival Protection - All Alphamat matboards feature Artcare MicroChamber Technology, for advanced protection against harmful pollutants.

Fade Resistant - Alphamat Artcare matboard features the industry's highest level of color permanence, with a consistency that stays true for the life of your art.

Bleed Resistant - All Alphamat Artcare matboard is bleed resistant to the highest required standards in the industry (*as per Library of Congress Standard #400-402).

Over 300 Colors - Alphamat Artcare offers the industry's largest choice in colour range for museum quality matboard, with specially selected colours, suitable for today's current trends.

Color Cores - Over 25 different coloured core, museum quality matboard, in 5 popular core colors.

Oversized - Over 75 colours available in oversized 40" x 60" sheets.



Alphasag Artcare



Made from the purest cotton rag pulp and subject to rigorous quality control, Alphasag Artcare meets or exceeds all industry standards for paper permanence. Plus, Artcare sets a new standard for preventative protection that is unique in the field of art conservation.



Meets quality standards set by the Fine Art Trade Guild.

Bainbridge Fabrics and Textures

Nielsen Bainbridge offers the most extensive range of Fabrics & Textures, so you and your customers remain at the cutting edge of design. All Fabrics & Textures are featured on Alphamat Artcare archival core and backing, for timeless style and long-lasting beauty. Layering fabrics and textures adds depth and drama to any home decor. From luxurious Suedes to New Threads and Metallic Rice Papers, from delicate Silks to timeless Linens; you won't find a more extensive line anywhere.

• Bainbridge Matboards stocked only in New York and San Francisco

• All prices shown are per sheet.

BAINBRIDGE PAPER MATS • 32 x 40				1-24: 7.29	25-49: 6.78	50+: 6.05					
B41	Charcoal	B346	Brazilian White	B716	French Blue	B774	Hemp	B824	Chantilly	B865	Laurel
B46	Dark Blue	B348	Harvest-Gold	B724	Gobelin Blue	B776	Peat	B825	Alabaster	B866	Burnt Orange
B47	Canary	BB377	Firecracker	B726	Autumn Gold	B777	Umber	B835	Wisteria	B868	Forest Green
B48	Maroon	B414	Sea Foam	B736	Mahogany	B778	Grey Beige	B836	Royal	B870	Sheepskin
B61	Super White	B586	Blue Jay	B742	Cerulean	B783	French Cream	B837	Midnight Blue	B871	Sepia
B65	Fabric White	B587	China Blue	B744	Sienna	B784	Desert Sand	B841	Juniper	B872	Silversmith
B71	Brilliant White	B589	Eucalyptus	B747	Timberline	B785	Dutch Blue	B842	Shamrock	B874	Independence-Blue
B79	Crimson	B593	Cranberry Mist	B748	Pewter	B786	Slate Blue	B843	Evergreen	B875	Herbal Green
B81	Ivory	B594	Maple Leaf	B750	Mountain-Grey	B788	Vanilla	B844	Seaside	BB876	Gravel
B84	Dark Green	B596	El-Dorado	B751	Ebony	B789	Granite	B847	Rose	B877	Olivine
B88	T.V. Grey	B598	Sahara	B752	Admiralty	BB791	Oyster	B849	Grape	B879	Sand
B89	Black	B599	Biscuit	B754	Porcelain	B794	Warm Grey	B852	Silverpine	B880	Quartz
B119	Chestnut	B692	Deep Honey	B756	Candlewick	B795	Slate	B853	Slate Green	B881	Silverstone
B128	Off White	B694	Autumn-Peak	BB760	Brique	B801	Blue Grey	B854	Caribbean Blue	B885	Delft Blue
B203	Cream	B697	Limon	B761	Gull Grey	B802	Green Whisper	B856	Lemonade	B886	Asphalt
B213	Gold	B700	Gingerbread	B762	Rouge	B804	Light-Azure	B858	Buttercup	B887	Chocolate Truffle
B215	Dull-Gold	B701	Ivy Leaf	B764	Stonehenge Greige	B805	Lavender Mist	B860	Baby Blue	B888	Sandpaper
B330	Clove	B704	Terrazzo Tan	B766	Cognac	B815	Ruby	B861	Basil	B889	Pinenut
B340	Tawny	B709	Extreme White	B770	Soapstone	B817	Liberty Blue	B862	Straw	B17172	Golden-Cloud
B342	Balsam	B710	Spiced Orange	B771	Paloma	B818	Nile Green	B863	Tulip		
B344	Khaki	B715	Meadow Green	B772	Bisque	B819	Alpine Blue	B864	Regatta		

BAINBRIDGE PAPER MATS • 40 x 60				1-24: 16.54	25-49: 15.36	50+: 13.73			
B71L	Brilliant White	B128L	Off White	B701L	Ivy leaf	B754L	Porcelain	B802L	Green Whisper
B81L	Ivory	B346L	Brazilian White	B709L	Extreme White	B770L	Soapstone	B824L	Chantilly
B88L	T.V. Grey	B589L	Eucalyptus	B726L	Autumn Gold	B786L	Slate Blue	B843L	Evergreen
B89L	Black	B593L	Cranberry Mist	B752L	Admiralty				

BAINBRIDGE PEBBLED MATS • 32 x 40				1-24: 6.57	25-49: 6.11	50+: 5.75	
B110	Off White & White	B115	T.V. Grey & White	B89P	Black & White		
B111	Cream & White	B211	Warm Grey & White				

BAINBRIDGE PEBBLED MATS • 40 x 60				1-24: 14.31	25-49: 13.60	50+: 12.60	
B110L	Off White & White	B111L	Cream & White	B211L	Warm Grey & White		

BAINBRIDGE FILLET MATS • 32 x 40				1-24: 5.89	25-49: 5.48	50+: 4.88	
B310	Tiara	B312	Bronze	BB311	Sterling		

BAINBRIDGE UNBUFFERED PHOTO RAG (4 PLY) • 32 x 40				1-24: 18.94	25-49: 17.61	50+: 15.71	
B6601	Pure White	B8656	Natural White				

BAINBRIDGE CONSERVATION BASICS • 32 x 40				1-24: 6.86	25-49: 6.38	50+: 5.69			
B12001	Nougat	B12010	Cork	B12019	Leaf	B12028	Red Pepper	B12089	Flame
B12002	Manila	B12011	Kale	B12020	Iron	B12029	Peppercorn	B12090	Myrtle
B12003	Brown	B12012	Storm Cloud	B12021	Anthracite	B12030	Blue Moon	B12091	Chartreuse
B12004	Kid Glove	B12013	Chocolate	B12022	Daisy	B12083	Light Grey	B12092	Aquarius
B12005	Cotton	B12014	Portabella	B12023	Snowdrop	B12084	Black Olive	B12093	Dragonfly
B12006	Primer White	B12015	Truffle	B12024	Bungalow	B12085	Marshmallow	B12094	Ultra Violet
B12007	Meringue	B12016	Bridal Veil	B12025	True Blue	B12086	Castlerock	B12095	Port
B12008	Whipped Cream	B12017	Corinthian White	B12026	Navy	B12087	Brightest White	B12096	Purple Heart
B12009	Camel	B12018	Scone	B12027	True Red	B12088	Egret		

BAINBRIDGE CONSERVATION BASICS • 40 x 60				1-24: 13.73	25-49: 12.77	50+: 11.39			
B12001L	Nougat	B12007L	Meringue	B12013L	Chocolate	B12019L	Leaf	B12025L	True Blue
B12002L	Manila	B12008L	Whipped Cream	B12014L	Portabella	B12020L	Iron	B12026L	Navy
B12003L	Brown	B12009L	Camel	B12015L	Truffle	B12021L	Anthracite	B12027L	True Red
B12004L	Kid Glove	B12010L	Cork	B12016L	Bridal Veil	B12022L	Daisy	B12028L	Red Pepper
B12005L	Cotton	B12011L	Kale	B12017L	Corinthian White	B12023L	Snowdrop	B12029L	Peppercorn
B12006L	Primer White	B12012L	Storm Cloud	B12018L	Scone	B12024L	Bungalow	B12030L	Blue Moon

• All prices shown are per sheet.

BAINBRIDGE CONSERVATION BASICS (8-PLY) • 32 x 40 **1-24: 13.06** **25-49: 12.15** **50+: 10.84**

BTM12025 Tru Blue BTM12027 Tru Red

BAINBRIDGE CONSERVATION BASICS BLACK CORE (4-PLY) • 32 x 40 **1-24: 9.75** **25-49: 9.07** **50+: 8.09**

B13006 Primer White B13016 Bridal Veil B13025 Tru Blue
B13012 Storm Cloud B13021 Anthracite B13027 Tru Red

BAINBRIDGE CONSERVATION BASICS NEW THREADS (4-PLY) • 32 x 40 **1-24: 19.07** **25-49: 17.73** **50+: 15.83**

B4099 Nightshade B4104 White B4115 Forest Floor B4126 Majestic Brown B4132 Bamboo
B4101 Navy B4111 Scarlet B4116 Courtyard B4127 Brick Oven B4135 Cafe Au Lait

BAINBRIDGE CONSERVATION BASICS NEW THREADS (4-PLY) • 40 x 60 **1-24: 35.87** **25-49: 33.36** **50+: 29.77**

B4099L Nightshade B4104L White B4126L Majestic Brown B4135L Cafe Au Lait
B4101L Navy B4115L Forest Floor B4127L Brick Oven

BAINBRIDGE CONSERVATION BASICS SUEDE (4-PLY) • 32 x 40 **1-24: 21.36** **25-49: 19.86** **50+: 17.73**

B4149 Wine B4151 Sonoma B4176 White B4221 Sundrenched B4233 Balsam
B4150 Midnight B4165 Coal B4197 Shadow B4223 Blaze B4236 Blueberry

BAINBRIDGE CONSERVATION BASICS SUEDE (4-PLY) • 40 x 60 **1-24: 38.92** **25-49: 36.20** **50+: 32.30**

B4150L Midnight B4176L White B4233L Balsam
B4165L Coal B4223L Blaze B4236L Blueberry

ALPHARAG ARTCARE (1-PLY) • 32 x 40 **1-24: 4.85** **25-49: 4.53** **50+: 4.03**

B8649 White 1 ply

ALPHARAG ARTCARE (2-PLY) • 32 x 40 **1-24: 9.55** **25-49: 8.88** **50+: 7.92**

B8632 White 2 ply B8654 Pure White 2 ply

ALPHARAG ARTCARE WHITES (4-PLY) • 32 x 40 **1-24: 18.36** **25-49: 17.07** **50+: 15.24**

B8634 White B8647 Pearl White B8655 Pure White B8688 Glacier White
B8640 Antique White B8652 Heritage White B8656 Natural White

ALPHARAG ARTCARE WHITES (4-PLY) • 40 x 60 **1-24: 34.97** **25-49: 32.52** **50+: 29.02**

B8634L White B8647L Pearl White B8656L Natural White
B8640L Antique White B8655L Pure White

ALPHARAG ARTCARE WHITES (8-PLY) • 32 x 40 **1-24: 40.83** **25-49: 37.97** **50+: 33.89**

B8640-8 Antique White B8653 Pure White
B8647-8 Pearl White B8660 White

ALPHARAG ARTCARE WHITES (8-PLY) • 40 x 60 **1-24: 79.43** **25-49: 73.87** **50+: 65.93**

B8634-8L White B8647-8L Pearl White B8653L Pure White

ALPHARAG ARTCARE LIGHTS (4-PLY) • 32 x 40 **1-24: 19.41** **25-49: 18.05** **50+: 16.11**

B8642 Cream B8646 Khaki B8665 Tumbleweed B8668 Ecru
B8643 Dove Grey B8648 Taupe B8666 Sand B8674 Stone
B8645 Ivory B8664 Special Cream B8667 Colonial Cream B8676 Lichen

ALPHARAG ARTCARE LIGHTS (4-PLY) • 40 x 60 **1-24: 36.42** **25-49: 33.87** **50+: 30.23**

B8642L Cream B8664L Special Cream
B8645L Ivory B8667L Colonial Cream
B8646L Khaki

• All prices shown are per sheet.

ALPHARAG ARTCARE LIGHTS (8-PLY) • 32 x 40 **1-24: 41.09** **25-49: 38.89** **50+: 35.99**

B8645-8 Ivory B8646-8 Khaki B8665-8 Tumbleweed

ALPHARAG ARTCARE DARKS (4-PLY) • 32 x 40 **1-24: 23.24** **25-49: 21.61** **50+: 19.29**

B8629 Fresh Hay B8651 Colonial Blue B8669 Black Shadow B8678 Coir
B8644 Ebony B8663 Natural Black B8673 Deep Sage B8690 Toasted Wheat (Naturals)

ALPHARAG ARTCARE DARKS (4-PLY) • 40 x 60 **1-24: 50.97** **25-49: 47.40** **50+: 42.29**

B8644L Ebony B8663L Natural Black B8669L Black Shadow B8673L Deep Sage

ALPHARAG ARTCARE DARKS (8-PLY) • 32 x 40 **1-24: 50.57** **25-49: 47.02** **50+: 41.97**

B8644-8 Ebony B8663-8 Natural Black B8669-8 Black Shadow

ALPHARAG ARTCARE STANDARD (1-PLY & 2-PLY) • 32 x 40

B8601 White 1ply **1-24: 4.22** **25-49: 3.92** **50+: 3.50**

ALPHARAG ARTCARE STANDARD (4 PLY) • 32 x 40 **1-24: 15.47** **25-49: 14.39** **50+: 12.84**

B8605 White

ALPHAMAT ARTCARE • 32 x 40 **1-24: 13.20** **25-49: 12.28** **50+: 10.95**

B8013 Matador	B8261 Goosedown	B8442 Kona	B8475 Olympian Blue	B8518 Ash	B8567 Dusk Grey
B8052 Precious Pink	B8262 Polar White	B8443 Teak	B8478 Romanesque Grape	B8519 Snowflake	B8570 Ice Blue
B8055 Ardent Blue	B8263 Beeswax	B8444 Pecan	B8479 Imperial Plum	B8520 Talc	B8571 Hunter Green
B8056 Balmy Blue	B8264 Wild Olive	B8445 Fiddlehead	B8480 Gothic Amethyst	B8521 Fairfield White	B8572 Blue Spruce
B8104 Sage	B8265 Tabasco	B8446 Raffia	B8483 Baroque Ruby	B8522 Cobblestone	B8573 Tapestry
B8105 Blue Iris	B8266 Loam	B8447 Black Spruce	B8484 Venetian Garnet	B8525 Almond	B8574 Sapphire
B8107 Peacock	B8401 Biscotti	B8448 Jalapeno	B8485 Renaissance Gold	B8526 Indigo	B8575 Violet
B8108 Sherry	B8408 Saffron	B8450 Denim Blue	B8486 Arabian White	B8527 Almandine	B8577 Blush
B8151 Palm	B8409 Amber	B8451 Mulberry	B8487 Palomino	B8528 Garnet	B8583 Pale Mauve
B8153 Jute	B8412 Green Olive	B8453 Cayenne	B8488 Sand Dune	B8531 Spice	B8584 Periwinkle
B8155 Fiori	B8417 Venetian Blue	B8454 Marigold	B8489 Lasso	B8533 Brittany	B8585 Jonquil
B8156 Prato	B8418 Charleston Green	B8455 Maize	B8490 Pueblo	B8534 Flemish Blue	B8586 Iris
B8157 Verde	B8420 Softly Pink	B8456 Fog	B8495 Desert Dawn	B8535 Moroccan Sand	B8587 Bellflower Blue
B8158 Sole	B8424 Chameleon	B8458 Smoke	B8500 Shell	B8536 Heather Mist	B8589 Teal Blue
B8159 Mare	B8425 Sea Green	B8460 Quaker Grey	B8502 Mimosa	B8539 Briarwood	B8591 Right Red
B8160 Luna	B8426 Parakeet	B8461 Gun Metal	B8503 Chamois	B8540 Tartan Green	B8592 Bordeaux
B8161 Terra	B8427 Red Clay	B8462 Wheat	B8504 Shadow Blue	B8544 Photo Grey	B8593 Steel Grey
B8162 Fango	B8428 Papaya	B8463 Spanish White	B8505 Teal Grey	B8545 Catawba	B8597 Flagstone
B8180 Mocha	B8429 Orchid	B8464 Matte White	B8506 Tuscan Brown	B8550 Calabash	B8599 Twilight
B8181 Matte Black	B8431 Antique	B8465 Igloo	B8509 Malacca	B8551 Baltic Green	
B8182 Rainforest Green	B8432 Angora	B8466 Frost	B8510 Annapolis Blue	B8552 Carmine	
B8183 Darkest Blue	B8433 Jet	B8467 French White	B8511 Sea Mist	B8555 Nimbus	
B8184 Black Cherry	B8434 Coal	B8468 Medieval Forest	B8512 Sorrel	B8556 Kirkwood	
B8186 Light Stone	B8435 Chrome	B8469 Stuart Green	B8513 Celadon	B8559 Photo White	
B8189 Toasted Almond	B8437 Clover	B8470 Etruscan Bronze	B8514 Sonora	B8560 Sultan Sand	
B8191 Antique Taupe	B8438 Chalk	B8471 Dynasty Celadon	B8515 Dover Grey	B8563 Taupe	
B8192 Fiery Red	B8440 Aubergine	B8473 Florentine Lapis	B8516 Pampas	B8564 Powder Rose	
B8260 Ice White	B8441 Chaps	B8474 Persian Sapphire	B8517 Ivory Black	B8565 Olde Rose	

ALPHAMAT ARTCARE • 40 x 60 **1-24: 26.52** **25-49: 24.57** **50+: 22.01**

B8108L Sherry	B8462L Wheat	B8487L Palomino	B8520L Talc	B8555L Nimbus
B8181L Matte Black	B8463L Spanish White	B8488L Sand Dune	B8521L Fairfield White	B8559L Photo White
B8260L Ice White	B8464L Matte White	B8502L Mimosa	B8522L Cobblestone	B8560L Sultan Sand
B8415L Riviera Red	B8465L Igloo	B8503L Chamois	B8525L Almond	B8563L Taupe
B8417L Venetian Blue	B8466L Frost	B8505L Teal Grey	B8526L Indigo	B8567L Dusk Grey
B8433L Jet	B8467L French White	B8506L Tuscan Brown	B8527L Almandine	B8570L Ice Blue
B8438L Chalk	B8470L Etruscan Bronze	B8509L Malacca	B8528L Garnet	B8574L Sapphire
B8441L Chaps	B8471L Dynasty Celadon	B8511L Sea Mist	B8533L Brittany	B8585L Jonquil
B8445L Fiddlehead	B8473L Florentine Lapis	B8515L Dover Grey	B8535L Moroccan Sand	B8592L Bordeaux
B8447L Black Spruce	B8479L Imperial Plum	B8516L Pampas	B8536L Heather Mist	B8593L Steel Grey
B8448L Jalapeno	B8483L Baroque Ruby	B8517L Ivory Black	B8539L Briarwood	
B8450L Denim Blue	B8485L Renaissance Gold	B8518L Ash	B8540L Tartan Green	
B8454L Marigold	B8486L Arabian White	B8519L Snowflake	B8552L Carmine	

• All prices shown are per sheet.

BAINBRIDGE ALPHA ESSENTIALS SOLID CORE (4 PLY) • 32 x 40 **1-24: 16.11** **25-49: 14.98** **50+: 13.37**

B8740 Solid White	B8744 Solid Malacca	B8748 Solid Prato	B8752 Solid Fango	B8756 Solid Ecru	B8760 Solid Pearl
B8741 Solid Black	B8745 Solid Pampas	B8749 Solid Chrome	B8753 Solid Mocha	B8757 Solid Ebony	
B8742 Solid Wheat	B8746 Solid Spice	B8750 Solid Loam	B8754 Solid Stone	B8758 Solid Ivory	
B8743 Solid Sand	B8747 Solid Grey	B8751 Solid Ash	B8755 Solid Khaki	B8759 Solid Slate	

BAINBRIDGE ALPHA ESSENTIALS SOLID CORE (4 PLY) • 40 x 60 **1-24: 32.19** **25-49: 29.94** **50+: 26.72**

B8740L Solid White	B8741L Solid Black	B8742L Solid Wheat	B8743L Solid Sand	B8755L Solid Khaki
--------------------	--------------------	--------------------	-------------------	--------------------

BAINBRIDGE ALPHA ESSENTIALS SOLID CORE (8 PLY) • 32 x 40 **1-24: 32.83** **25-49: 30.53** **50+: 27.25**

B8740-8 Solid White	B8742-8 Wheat	BTM8743 Sand	BTM8746 Spice	BTM8749 Chrome	BTM8751 Ash
B8741-8 Solid Black	B8747-8 Grey	BTM8744 Malacca	BTM8748 Prato	BTM8750 Loam	

BTM8012 Onyx	1-24: 30.25	25-49: 28.13	50+: 25.11
--------------	--------------------	---------------------	-------------------

BAINBRIDGE ALPHA ESSENTIALS SOLID CORE (8 PLY) • 40 x 60 **1-24: 66.81** **25-49: 62.13** **50+: 55.45**

B8740-8L Solid White	B8741-8L Solid Black
----------------------	----------------------

BAINBRIDGE ALPHA LINEN • 32 x 40 **1-24: 44.52** **25-49: 41.40** **50+: 36.95**

B4020 Raphael Cloud	B4022 Seurat Sand	B4024 Vermeer Black	B4027 Gauguin Green
B4021 Monet Lily	B4023 Rembrandt Shadow	B4025 Titian Gold	

ALPHAMAT ARTCARE ANTIQUE METALS • 32 x 40 **1-24: 17.81** **25-49: 16.56** **50+: 14.78**

B998006 Rustic Pewter	B998008 Gold Bullion	B108506 Chocolate Swirl	B848539 Bronzed Maple
-----------------------	----------------------	-------------------------	-----------------------

ALPHAMAT ARTCARE ANTIQUE METALS • 40 x 60 **1-24: 34.92** **25-49: 32.48** **50+: 28.98**

B108506L Chocolate Swirl	B848539L Bronzed Maple
--------------------------	------------------------

BAINBRIDGE CRUSHED CHIFFONS • 32 x 40 **1-24: 39.96** **25-49: 37.16** **50+: 33.17**

B4030 Iced Latte	B4031 Star Sapphire	B4032 Obsidian	B4033 Quicksilver	B4034 Frosted Sand	B4035 Cultured Pearl
------------------	---------------------	----------------	-------------------	--------------------	----------------------

ALPHAMAT ARTCARE DISTRESSED OLD WORLD METALS • 32 x 40 **1-24: 44.95** **25-49: 41.80** **50+: 37.31**

B4311 Antique Pewter	B4312 Gilded Cream	B4313 Sterling	B4314 Worn Brass	B4315 Travertine	B4316 Grey Slate
---------------------------------	--------------------	---------------------------	------------------	------------------	------------------

BAINBRIDGE DRIFTWOODS • 32 x 40 **1-24: 39.96** **25-49: 37.16** **50+: 33.17**

B4330 Tamarack	B4331 Sycamore	B4332 Buckeye	B4333 Ashbark
----------------	----------------	--------------------------	---------------

ALPHAMAT ARTCARE EARTHSTONES • 32 x 40 **1-24: 16.34** **25-49: 15.20** **50+: 13.56**

B8140 Topaz	B8305 Featherstone/Black Sable	B8802 Aztec Sand	B8805 Flint	B8809 Feldspar	B8822 Sandcastle
B8141 Smithsonite	B8801 Featherstone	B8804 Bedrock	B8806 Pebble Blue	B8812 Zinc	B8881 Feldspar/Tapestry Blue

ALPHAMAT ARTCARE EARTHSTONES • 40 x 60 **1-24: 30.03** **25-49: 27.93** **50+: 24.93**

B8801L Featherstone

ALPHAMAT ARTCARE TUSCANY • 32 x 40 **1-24: 17.81** **25-49: 16.56** **50+: 14.78**

B928155 Fiori Grotto	B928157 Verde Grotto	B928159 Mare Grotto	B928162 Fango Grotto
B928156 Prato Grotto	B928158 Sole Grotto	B928161 Terra Grotto	

ALPHAMAT ARTCARE HERITAGE • 32 x 40 **1-24: 17.81** **25-49: 16.56** **50+: 14.78**

B768161 Goldmine	B848433 Baroque Black	B848512 Empire Gold	B878526 Renaissance Blue
B768521 Sun Bleached	B848440 Imperial Mauve	B878454 Sweet Potato	B878540 Gothic Green
B768525 Weathered Oak	B848443 Antique Sienna	B878455 Apple Cider	B878559 Victorian Cameo
B768528 Barnyard	B848483 Tudor Red	B878503 Rococo Cream	B888503 Equestrian Brown

• All prices shown are per sheet.

BAINBRIDGE METALLIC RICE PAPERS • 32 x 40 1-24: **39.96** 25-49: **37.16** 50+: **33.17**

B4013 Candlelight Silver	B4015 Black Pearl	B4017 Copper Palace	B4701 Merchant Green	B4703 Lancelot
B4014 Evening Slipper	B4016 Ballroom Gold	B4700 White Armor	B4702 Gold Coin	

BAINBRIDGE OLD WORLD METALLICS • 32 x 40 1-24: **39.96** 25-49: **37.16** 50+: **33.17**

B4300 Cinnabar	B4301 Faberge Gold	B4302 Silver Leaf	B4303 Aragon	B4366 Spun Gold
----------------	--------------------	-------------------	--------------	-----------------

BAINBRIDGE TAILORED TEXTILES • 32 x 40 1-24: **39.96** 25-49: **37.16** 50+: **33.17**

B4420 Burlap	B4427 Chino	B4428 Heather Grey
--------------	-------------	--------------------

ALPHAMAT ARTCARE PARCHMENTS • 32 x 40 1-24: **16.34** 25-49: **15.20** 50+: **13.56**

B8815 Muslin	B8816 Flax
--------------	------------

ALPHAMAT ARTCARE PRECIOUS METALS • 32 x 40 1-24: **17.29** 25-49: **16.08** 50+: **14.35**

B8002 Silver	B8008 Brushed Gold	B8015 Smoky Topaz	B8085 Nickel	B8092 Ice	B8096 Bronze
B8003 Gold	B8009 Patina Gold	B8016 Jademond	B8086 Brass Band	B8093 Real Red	B8097 Aluminum
B8004 Warm Gold	B8010 Patina Copper	B8017 Rubellite	B8090 Champagne	B8094 Patriot Blue	B8098 Pearl
B8006 Brushed Silver	B8012 Brushed Onyx	B8018 Blue Tanzanite	B8091 Cinnamon	B8095 Mink	
B8007 Brushed Pale	B8014 Grey Quartz	B8083 Golden Mocha			

ALPHAMAT ARTCARE PRECIOUS METALS • 40 x 60 1-24: **33.99** 25-49: **31.61** 50+: **28.21**

B8003L Gold	B8010L Patina Copper	B8012L Brushed Onyx
-------------	----------------------	---------------------

ALPHAMAT ARTCARE PRECIOUS METALS COLOR CORE • 32 x 40 1-24: **17.29** 25-49: **16.08** 50+: **14.35**

B8321 Brushed Onyx Sable Core

ALPHAMAT ARTCARE PRECIOUS METALS COLOR CORE • 40 x 60 1-24: **33.99** 25-49: **31.61** 50+: **28.21**

B8321L Brushed Onyx Sable Core

ALPHAMAT ARTCARE ANIMATIONS • 32 x 40 1-24: **17.29** 25-49: **16.08** 50+: **14.35**

B8027 Mango	B8029 Carnation	B8031 Thistle	B8034 Azure Cloud	B8036 Bermuda Mist	B8038 Lime Froth
B8028 Mango Mousse	B8030 Pink Carnation	B8032 Thistle Down	B8035 Bermuda	B8037 Lime	

ALPHAMAT ARTCARE SPORTS • 32 x 40 1-24: **17.29** 25-49: **16.08** 50+: **14.35**

B8019 Orange Pop	B8022 Lemon Drop	B8025 Real Teal
B8020 Red Rave	B8024 Purple Passion	

ALPHAMAT ARTCARE IMPRESSIONS • 32 x 40 1-24: **16.17** 25-49: **15.04** 50+: **13.43**

B8850 Arabian Fossil

ALPHAMAT ARTCARE CLASSIC IMPRESSIONS • 32 x 40 1-24: **16.54** 25-49: **15.38** 50+: **13.73**

B8119 Ivory Canvas

BAINBRIDGE RICE PAPERS • 32 x 40 1-24: **37.96** 25-49: **35.30** 50+: **31.51**

B4001 Black Luster	B4007 Lamplight	B4009 Sage Mist
B4003 Candlelight	B4008 Gold Dust	

ALPHAMAT ARTCARE RUSTIC ESSENTIALS • 32 x 40 1-24: **21.35** 25-49: **19.86** 50+: **17.72**

B998741 Old Bronze	B998746 Terracotta	B998751 Ironwork	B998754 Steel Patina
B998743 Vintage Oak	B998747 Weathered Zinc	B998752 Dark Clay	

ALPHAMAT ARTCARE SAMUI • 32 x 40 1-24: **17.29** 25-49: **16.08** 50+: **14.35**

B8129 Sea Grass

BLACK BY BAINBRIDGE • 32 x 40 1-24: **9.67** 25-49: **8.99** 50+: **8.02**

B5079 Crimson / Black Core	B5754 Porcelain / Black Core	B5876 Gravel / Black Core
B5089 Black / Black Core	B5770 Soapstone / Black Core	B5879 Sand / Black Core
B5742 Cerulean / Black Core	B5843 Evergreen / Black Core	B5880 Quartz / Black Core

BLACK BY BAINBRIDGE • 40 x 60 1-24: **20.49** 25-49: **19.06** 50+: **17.01**

B5089L Black / Black Core	B5754L Porcelain / Black Core
---------------------------	-------------------------------

• All prices shown are per sheet.

BAINBRIDGE FORMALS • 32 x 40 1-24: **16.54** 25-49: **12.80** 50+: **11.42**

B7501 Platinum B7506 Graphite B7515 White Birch B9506 Graphite/Black Core
 B7504 Gentle Gold B7513 Iron Grille B7520 Burnished Gold

ALPHAMAT ARTCARE COLOR CORE • 32 x 40 1-24: **16.34** 25-49: **15.20** 50+: **13.56**

B8301 Ivory Black/Black Sable B8310 Tartan Green/Black Sable B8317 Steel Grey/Black Sable B8837 Tuscan Brown/Antique Buff
 B8304 Flint/Black Sable ~~B8311 Baroque Ruby/Black Sable~~ B8318 Malacca/Black Sable B8841 Ash/Photo Grey
 B8306 Matte White/Black Sable B8313 Snowflake/Black Sable B8319 Teal Grey/Black Sable B8880 Tapestry/Tapestry Blue
 B8307 Frost/Black Sable B8314 Talc/Black Sable B8320 Taupe/Black Sable B8883 Ice Blue/Tapestry Blue
 B8308 Sea Mist/Black Sable B8315 Fairfield White/Black Sable B8836 Palomino/Antique Buff B8885 Snowflake/Tapestry Blue
 B8309 Etruscan Bronze/Black Sable

ALPHAMAT ARTCARE COLOR CORE • 40 x 60 1-24: **32.11** 25-49: **29.86** 50+: **26.65**

B8301L Ivory Black/Black Sable ~~B8306L Matte White/Black Sable~~ B8313L Snowflake/Black Sable

ALPHAMAT SPECIALTIES • 32 x 40 1-24: **17.29** 25-49: **16.08** 50+: **14.35**

B8039 Light Olive B8041 Dark Olive B8043 Medium Marine B8060 Urban Grey B8063 Desert
 B8040 Medium Olive B8042 Light Marine B8044 Dark Marine B8061 Urban Black

ALPHAMAT ARTCARE ULTRA THICK • 32 x 40 1-24: **20.81** 25-49: **19.35** 50+: **17.27**

BTM8462 Wheat BTM8464 Matte White BTM8466 Frost BTM8519 Snowflake BTM8559 Photo White
 BTM8463 Spanish White BTM8465 Igloo BTM8517 Ivory Black BTM8520 Talc

ALPHAMAT ARTCARE ULTRA THICK • 40 x 60 1-24: **41.59** 25-49: **38.68** 50+: **34.52**

BTM8463L Spanish White BTM8465L Igloo
 BTM8464L Matte White BTM8517L Ivory Black

ALPHAMAT ARTCARE ULTRA THICK COLOR CORE • 32 x 40 1-24: **22.13** 25-49: **20.58** 50+: **18.36**

BTM8301 Ivory Black/Sable BTM8321 Spanish White/Sable

ALPHAMAT ARTCARE ULTRA THICK COLOR CORE • 40 x 60 1-24: **43.18** 25-49: **40.14** 50+: **35.84**

BTM8301L Ivory Black /Sable BTM8321L Spanish White/Sable

BAINBRIDGE GLAZED LINENS • 32 x 40 1-24: **39.96** 25-49: **37.16** 50+: **33.17**

B4075 Peat Moss B4080 Charred Black B4282 Forget Me Not B4285 Creme Brulee B4289 Dusty Ash
 B4078 Brick Wall B4280 Blue Jean ~~B4283 River Rock~~ ~~B4286 Heath~~ B4290 Graphite
 B4079 Oatmeal B4281 Oasis B4284 Pot O' Gold B4288 Cranberry B4291 Sawdust

ALPHAMAT ARTCARE LEATHERS • 32 x 40 1-24: **17.29** 25-49: **16.08** 50+: **14.35**

B8251 Moccasin Leather B8255 Bluebuck Leather
 B8254 Cowhide Leather B8259 Sable Leather

BAINBRIDGE NEW THREADS • 32 x 40 1-24: **30.80** 25-49: **28.64** 50+: **25.56**

B4091 Meringue B4113 Autumn Frost B4118 Aegean Blue B4121 Orange Zest
 B4097 Camel B4114 Enchanted Purple B4119 Grappa B4122 Pharaoh Gold
 B4112 Watchet Blue B4117 Grecian White B4120 Spartan B4125 Ancient Stone

BAINBRIDGE NEW THREADS • 40 x 60 1-24: **56.11** 25-49: **52.18** 50+: **46.57**

B4097L Camel B4112L Watchet Blue B4114L Enchanted Purple B4119L Grappa
 B4111L Scarlet B4113L Autumn Frost B4116L Courtyard B4120L Spartan

• All prices shown are per sheet.

BAINBRIDGE SUEDE MATS • 32 x 40				1-24: 35.94	25-49: 33.42	50+: 29.83
B4143 Tumbleweed	B4157 Grey	B4180 Cabernet	B4201 Mare	B4213 Chocolate		
B4144 Palomino	B4159 Dusty Blue	B4181 Gold Rush	B4202 Luna	B4214 Loden		
B4145 Mustang	B4160 Blossom	B4182 Turquoise	B4204 Woodland Green	B4216 Vivid Purple		
B4146 Willow	B4162 Rosewood	B4183 Persimmon	B4205 Terra	B4222 Sunburst		
B4147 Spruce	B4163 Bayberry	B4184 Thistle	B4206 Fango	B4224 Black Sea		
B4148 Moss	B4169 Lapis	B4193 Vineyard	B4207 Dark Berry	B4227 Lemon Ice		
B4153 Jacana	B4172 Cactus	B4194 Violet	B4208 Black Currant	B4228 Raspberry Fizz		
B4154 Targa	B4175 Fawn	B4195 Dusk	B4209 Hydrangea	B4229 Tangerine Twist		
B4155 True Grit	B4177 Aluminum	B4198 Breeze	B4210 Prato	B4230 Amethyst		
B4156 Rye	B4179 Noel	B4199 Verde	B4211 Fiori	B4231 Cybergreen		
		B4200 Sole	B4212 Sail Blue	B4232 Vivid Turquoise		

BAINBRIDGE SUEDE MATS • 40 x 60				1-24: 60.40	25-49: 56.17	50+: 50.13
B4143L Tumbleweed	B4157L Grey	B4181L Gold Rush	B4202L Luna	B4221L Sundrenched		
B4144L Palomino	B4159L Dusty Blue	B4182L Turquoise	B4204L Woodland Green	B4224L Black Sea		
B4145L Mustang	B4160L Blossom	B4183L Persimmon	B4205L Terra	B4225L Fresh Orange		
B4146L Willow	B4162L Rosewood	B4184L Thistle	B4206L Fango			
B4148L Moss	B4163L Bayberry	B4193L Vineyard	B4207L Dark Berry			
B4149L Wine	B4169L Lapis	B4194L Violet	B4209L Hydrangea			
B4151L Sonoma	B4172L Cactus	B4195L Dusk	B4210L Prato			
B4153L Jacana	B4175L Fawn	B4197L Shadow	B4211L Fiori			
B4154L Targa	B4177L Aluminum	B4198L Breeze	B4212L Sail Blue			
B4155L True Grit	B4179L Noel	B4199L Verde	B4213L Chocolate			
B4156L Rye	B4180L Cabernet	B4200L Sole	B4214L Loden			
		B4201L Mare	B4216L Vivid Purple			

BAINBRIDGE TURF • 32 x 40				1-24: 45.72	25-49: 42.52	50+: 37.95
B4310 Astro Turf	B4361 Dartboard	B4362 Baseline	B4363 Asphalt			

BAINBRIDGE GRASSCLOTH • 32 x 40				1-24: 45.55	25-49: 42.36	50+: 37.81
B4400 Tahitian Fan	B4401 Basket Weave	B4402 Dune Grass	B4403 Sun Shade	B4404 Sisal	B4406 White Weave	

BAINBRIDGE SILKEN • 32 x 40				1-24: 43.93	25-49: 40.85	50+: 36.46
B4830 Snow	B4837 Burgundy	B4842 Arid Gold	B4846 Molten	B4850 Wasabi		
B4834 Petal Green	B4838 Dynasty Red	B4843 Wheatfield	B4847 Meadowland	B4851 Tabriz		
B4835 Mountain Green	B4840 White	B4844 Burnt Ember	B4848 Shitake	B4852 Coriander		
B4836 Imperial Blue	B4841 Bamboo	B4845 Lavender Haze	B4849 Buddha			

BAINBRIDGE SILKEN • 40 x 60				1-24: 88.01	25-49: 81.85	50+: 73.05
B4836L Imperial Blue	B4838L Dynasty Red	B4844L Burnt Ember				
B4837L Burgundy	B4840L White	B4846L Molten				

BAINBRIDGE SHANTUNG • 32 x 40				1-24: 36.86	25-49: 34.28	50+: 30.59
B4853 Dolphin	B4855 New Moon	B4857 Passion Fruit	B4859 Coconut			
B4854 Caffe	B4856 Cottage Blue	B4858 Pimento				

BAINBRIDGE RAW SILK • 32 x 40				1-24: 46.66	25-49: 43.39	50+: 38.73
B4960 Oyster	B4962 Pearl	B4969 Truffle	B4973 Amber Gold			
B4961 Mink	B4964 Greenbrier	B4970 Black Knight	B4974 Chestnut			

BAINBRIDGE RAW SILK • 40 x 60				1-24: 88.95	25-49: 82.72	50+: 73.83
B4960L Oyster	B4961L Mink	B4962L Pearl				

BAINBRIDGE TATAMI SILK • 32 x 40				1-24: 46.75	25-49: 43.48	50+: 38.80
B4410 Golden Samurai	B4414 Firefly	B4418 Harmony Blue	B4424 Jasper	B4451 Pistachio		
B4411 Chai	B4415 Bonsai Brown	B4419 Kyoto Pearl	B4426 Caramel	B4452 Peach Melba		
B4412 Sake	B4416 Lily Pond	B4421 Fawn	B4429 Delft	B4453 Sundance		
B4413 Salt Grass	B4417 Hibachi	B4423 Candlestick	B4440 Dill	B4454 Violetta		

• All prices shown are per sheet.

BAINBRIDGE ALPHA MOUNT (2 PLY) • 32 x 40	1-24: 7.49	25-49: 6.97	50+: 6.22
---	-------------------	--------------------	------------------

B8732 White

BAINBRIDGE ALPHA MOUNT (4 PLY) • 32 x 40	1-24: 13.04	25-49: 12.13	50+: 10.82
---	--------------------	---------------------	-------------------

B8734 White

BAINBRIDGE ALPHA MOUNT (4 PLY) • 40 x 60	1-24: 28.66	25-49: 26.65	50+: 23.79
---	--------------------	---------------------	-------------------

B8734L White

BAINBRIDGE BEVEL ACCENTS	1-3: 28.12	4+: 26.43
---------------------------------	-------------------	------------------

AlphaMat Artcare Paper

- BA8005 Copper
- BA8448 Jalapeno
- BA8450 Denim Blue
- BA8526 Indigo
- BA8540 Tartan Green

Specialty Fabrics	1-3: 33.15	4+: 31.15
--------------------------	-------------------	------------------

- BA4147 Spruce Suede
- BA4149 Wine Suede
- BA4165 Coal Suede
- BA4835 Silken Green
- BA4840 White Silk



Peterboro Matboards

Peterboro Matboards provides custom framers with matboards of superior quality at unparalleled value. Peterboro sets the standard for quality by using only premium grade materials and then individually inspecting each matboard. Product range includes Museum (100% cotton), Conservation alpha cellulose and cotton, Premium Whitecore, Blackcore, Creamcore, Silks, Linens, Weaves and Conservation Suede matboards.



Peterboro Regular Matboards

Peterboro Regular is a smooth cutting cream core matboard. Available in a wide range of colors and textures, Peterboro Regular is suitable for decorative, economical framing applications.

- Buffered to an alkaline pH
- Over 70 % of the surface papers are conservation grade, bleed and fade resistant
- Conservation grade backing paper
- Pulp core

Recommended For:

- Decorative framing and general-presentations
- Open end reproductions
- Posters and decorative art



Peterboro White Core Matboards

This premium Whitecore matboard is designed for customers who want the decorative impact of a bright white bevel but don't require conservation protection.

- Brite white bleached alpha cellulose core
- Buffered to an alkaline pH
- 80 % of the surface papers are conservation grade, bleed and fade resistant
- Conservation grade backing paper
- Suitable for use in non conservation, decorative framing applications

Recommended For:

- Decorative framing and general presentations
- Open end reproductions
- Posters and decorative art



Peterboro Black Core Matboards

Peterboro Blackcore is a high-quality matboard made with a black center that acts as an added element of design. Blackcore matboards can be used to highlight v-grooves, photographs and works of art without the use of a double mat.

- Buffered to an alkaline pH, rich, even, bleed resistant black core
- Easy to cut
- Conservation grade grey backing paper reduces rub off

Recommended For:

- Decorative framing and general presentations
- Open end reproductions and decorative art

⚠ California Customers- WARNING: Cancer and Reproductive Harm - www.P65Warnings.ca.gov

PETERBORO
CONSERVATION

Peterboro Conservation Matboards

Peterboro Conservation matboards are constructed in accordance with the international standards as defined by the Fine Art Trade Guild of London England.



- White high alpha cellulose core
- Contains no acid, lignin or ground wood
- Fade and bleed resistant surface papers
- Buffered to an alkaline pH
- Contains no optical brighteners
- Suitable for use in all conservation framing applications

Recommended For:

- Fine Art Prints
- Limited Editions
- Valuable Documents
- Photography



Fine Art Trade Guild & Fine Art Care & Treatment Standards

Over 100 years, the *Fine Art Trade Guild (FATG)* is one of the oldest international associations for the art and framing industry that sets and maintains standards with which the trade and its customers can be secure. Established in 1994, *FACTS* evolved from the ever-increasing need for information about the preservation of artwork and keepsakes. Standards are reviewed regularly to include new research and are recognized by the Professional Picture Framers Association (PPFA).



Peterboro Museum Matboards



Peterboro Museum matboards are constructed from the finest 100% cotton fiber and are constructed in accordance with the international standards as defined by the Fine Art Trade Guild of London England.

These 100% Cotton boards are of the finest quality as they maintain the purest form of natural cellulose, require little processing and maintain a history of performance. Accordingly, every board of this premium line adheres to both FACTS and the Fine Art Trade Guild's stringent specifications for Museum Matboards.

A 100% cotton board provides the comfort and assurance that matted artwork will be preserved for future generations and at present it is the top choice of framers, museums, and conservators for the mounting, matting, and preservation of fine prints and documents. Peterboro Museum allows framers to uphold the cotton tradition to its fullest while enhancing and protecting your artwork for years to come.

- 100% cotton fiber, solid color throughout
- Traditional ply construction, buffered with calcium carbonate
- Naturally acid and lignin free
- Suitable for use in Museum level framing applications
- Facing papers exceed minimum standards for fade and bleed as set by F.A.C.T.S. and F.A.T.G.
- pH 8.5 - 9.5, buffered with calcium carbonate to an alkaline reserve of 3 -5%
- 4 ply and 8 ply thicknesses. (Consult matboard specifier)
- Meets Museum Standards as set by F.A.C.T.S. and F.A.T.G.

Peterboro Museum board is recommended for:

- Valuable works of original art
- Surface papers are pigmented for fade and bleed resistance.
- Items of historical importance
- Treasured heirlooms

PETERBORO
DESIGNER
FABRICS

Peterboro Designer Fabrics

The sophistication of silks, the timeless elegance of linens and the classic look of a weave allow for new dimensions in style, creativity and affordability. Easy to cut at an exceptional value.

- White high alpha cellulose conservation core
- Free of acid, lignin and ground wood
- Buffered to an alkaline pH
- 100% virgin fiber conservation backing
- Contains no optical brighteners (Excluding Silk DF940 and Linen DF945)
- Suitable for use in all conservation framing applications

PETERBORO
DESIGNER
SUEDE

Peterboro Designer Suede

The attractive changes in color and texture, characteristic of suede, add a new dimension to matting. Whether it is used in shadowboxes, photos, art, or precious heirlooms, suede will always add a touch of elegance to any frame.

- A Conservation quality designer suede
- Vibrant surface colors with a dense luxurious flock
- Buffered to an alkaline pH, extra thick white bevel
- Suitable for all conservation framing applications

PETERBORO
MOUNT BOARDS

Peterboro Mount Boards

Mount Boards come in a variety of specifications to meet your everyday needs.

Grey Unlined Mountboards:

These boards are 100% buffered and come in both a 40pt and 80pt thickness.

Single Thick .040" : 28" x 44", 32" x 40", & 40" x 60"

Double Thick .080" : 28" x 44", 32" x 40", & 40" x 60"

Paper Lined Mountboards

These boards are lined on both sides and buffered.

Black paper lined .050" : 28" x 44"

White – Two Sides .055" : 28" x 44", 32" x 40", 40" x 60"

White – Two Sides .095" : 28" x 44", 32" x 40"

• All prices shown are per sheet.

Regular Core Mat Board • 32 x 40 (4 Ply) 1-24: **5.43** 25-49: **5.16** 50+: **4.89**

R101-109 Smooth White & Blk	R132 Peach	R319 Dark Blue	R345 Rust	R365 Moss Green	R386 Dark Black
R111 Dijon	R133 Lavender	R320 Crimson	R346 Storm Grey	R366 Cadet Grey	R388 Maize
R113 Citrus	R150-153 White & Cream	R321 Crystal White	R348 Powder Blue	R368 Blueberry	R389 Porpoise
R115 Talc	R160 White Eggshell	R322 Vanilla	R349 Off White	R369 Sparkling White	R391 Riviera Blue
R117 Thistle	R161 Lt. Cream Eggshell	R323 Atlantic	R351 Sunflower	R370 White	R392 Antique
R118 Lichen	R303 Goldenrod	R327 Sapphire	R352 Snow White	R371 Agate Grey	R394 Coral
R119 Balsam	R305 Evergreen	R331 Pumice	R353 Pale Grey	R372 Chalk	R395 Ivory
R120 Fathom	R306 Cardinal Red	R332 Flax	R354 Nickel	R373 Venetian Blue	R396 Pale Blue
R121 Peregrine	R307 Mist	R334 Raspberry	R356 Mocha	R375 Chinese Red	R399 Burnt Sienna
R122 Azure	R308 Bluejay	R335 Sand	R357 Silver Grey	R376 Silver Pine	R401 Feather Grey
R123 Pacific	R309 Brite White	R338 Haze	R358 Dark Grey	R377 Maroon	R402 Charcoal Grey
R124 Sahara	R310 Winter White	R339 Cocoa	R359 Claret	R378 Juniper	R404 Teakwood Black
R125 Sierra	R311 Silver White	R340 Spring Green	R360 Soft Grey	R379 Soft White	
R126 Saffron	R312 Burgundy	R341 Pecan	R361 Limoges	R380 Beaver Brown	
R127 Ash	R314 Forest Green	R342 Cognac	R362 Cedar	R381 Bisque	
R128 Smoke	R315 Terrace	R343 Coffee	R363 Taupe	R382 Plum	
R131 Apple Red	R317 Cirrus	R344 Rosewood	R364 Art Brown	R385 Trail	

Regular Core Designer Mat Board • 32 x 40 (4 Ply) 1-24: **5.86** 25-49: **5.57** 50+: **5.27**

R1419 Black Leather	R1411 Lace	R1412 Khaki			
R1420 Onyx			1-24: 7.70	25-49: 7.31	50+: 6.93

Regular Core Textured & Embossed Mat Board • 32 x 40 (4 Ply) 1-24: **5.43** 25-49: **5.16** 50+: **4.89**

R1304 Teakwood Black Linen	R1369 Linen Sparkling White	R1353 Linen India Tint			
R1350 Linen White	R251-259 Pebbled Wht./Light Cream				
R1401-14 Pebbled White/Black			1-24: 5.43	25-49: 5.16	50+: 4.89

Regular Core Foils Mat Board • 32 x 40 1-24: **6.53** 25-49: **6.21** 50+: **5.89**

R781 Smooth Gold	R782 Light Gold	R791 Mercury	R793 Light Silver		
R792 0.055" Gold Foil				1-24: 7.00	25-49: 6.65 50+: 6.29
R762 0.030" Gold Foil				1-24: 5.57	25-49: 5.29 50+: 5.01

Regular Core Giant Mat Board • 40 x 60 (4 Ply) 1-24: **9.41** 25-49: **8.94** 50+: **8.47**

RG6117 Thistle	RG6364 Art Brown	RG6373 Venetian Blue			
RG6312 Burgundy	RG6365 Moss Green				
RG6314 Forest Green	RG6368 Blueberry				
RG6150-6 White & Cream			1-24: 11.19	25-49: 10.64	50+: 10.08
RG6369 Sparkling White	RG6370 White	RG6404 Teakwood Black			

Whitecore Foils Mat Board • 32 x 40 1-24: **7.45** 25-49: **7.06** 50+: **6.70**

W781 Smooth Gold	W791 Mercury	W1795 Spun Gold			
W782 Light Gold	W792 0.055" Gold Foil	W1797 Gold Splash			
W793 Light Silver	W1794 Silver Splash	W5046 Aztec Gold			

• All prices shown are per sheet.

Whitecore Mat Board • 32 x 40 (4 Ply) 1-24: **6.25** 25-49: **5.94** 50+: **5.63**

• High Alpha Cellulose Bright White Core • Made with Conservation Quality backing paper • Buffered with calcium carbonate

W1000 Digital White	W5022 Burnt Orange	W5051 Overcast	W538 Haze	W568 Blueberry	W598 Wheat
W101 Smooth White	W5023 Royal Blue	W5052 Flint	W539 Cocoa	W569 Sparkling White	W599 Burnt Sienna
W101-109 Smooth White & Black	W5024 Real Red	W5053 Sandstorm	W540 Spring Green	W570 White	W600 Stone
W109 Black	W5025 Blue Stone	W5060 Cape Cod Grey	W541 Pecan	W571 Agate Grey	W601 Feather Grey
W1369 Linen Sparkling White	W5026 Teal	W505 Evergreen	W542 Cognac	W572 Chalk	W602 Charcoal Grey
W1501 Pebbled White	W5027 Wicker	W506 Cardinal Red	W543 Coffee	W573 Venetian Blue	W604 Teakwood Black
W1504 Black Linen	W5028 Dusty Cream	W507 Mist	W544 Rosewood	W575 Chinese Red	W611 Dijon
W1509 Pebbled Black	W5029 Buff	W508 Bluejay	W545 Rust	W576 Silver Pine	W613 Citrus
W1550 White Linen	W503 Goldenrod	W509 Brite White	W546 Storm Grey	W577 Maroon	W615 Talc
W5000 Antique Rose	W5030 Clover	W510 Winter White	W548 Powder Blue	W578 Juniper	W617 Thistle
W5001 Oatmeal	W5031 Midnight Black	W511 Silver White	W549 Off White	W579 Soft White	W618 Lichen
W5002 Cashew	W5032 Cobblestone	W512 Burgundy	W550 Georgian Blue	W580 Beaver Brown	W619 Balsam
W5003 Caribbean Blue	W5033 Medium Black	W514 Forest Green	W551 Sunflower	W581 Bisque	W620 Fathom
W5004 Antique Blue	W5034 Wine	W515 Terrace	W552 Snow White	W582 Plum	W621 Peregrine
W5005 Pink	W5035 Inspired White	W517 Cirrus	W553 Pale Grey	W583 Bamboo	W622 Azure
W5006 Olive	W5036 Siberian White	W518 Silica	W554 Nickel	W584 Canyon	W623 Pacific
W5007 Ice Pink	W5037 Brite Red	W519 Dark Blue	W555 Misty Grey	W585 Trail	W624 Sahara
W5008 Blush	W5038 Java	W520 Crimson	W556 Mocha	W586 Dark Black	W625 Sierra
W5009 Celery	W5039 Blue Heron	W521 Crystal White	W557 Silver Grey	W587 Dune	W626 Saffron
W5010 Soft Mauve	W5040 London Grey	W522 Vanilla	W558 Dark Grey	W588 Maize	W627 Ash
W5011 Victorian Rose	W5041 Egrit	W523 Atlantic	W559 Claret	W589 Porpoise	W628 Smoke
W5012 Beige	W5042 Pumpkin	W526 Tan	W560 Soft Grey	W590 Willow	W630 Cinnamon
W5013 Pearl	W5043 Midnight Blue	W527 Sapphire	W561 Limoges	W591 Riviera Blue	W631 Apple Red
W5014 Glacier White	W5044 Shamrock	W528 Aspen	W562 Cedar	W592 Antique	W632 Peach
W5015 African Violet	W5045 Persimmon	W529 Jurassic	W563 Taupe	W593 Classic Parchment	W633 Lavender
W5016 Dark Almond	W5047 Lemon	W531 Pumice	W564 Art Brown	W594 Coral	W660 White Eggshell
W5017 Ginger	W5048 Fern	W532 Flax	W565 Moss Green	W595 Ivory	
W5019 Ocean Grey	W5049 Spruce	W534 Raspberry	W566 Cadet Grey	W596 Pale Blue	
W5020 Tangerine	W5050 Cloudy Grey	W535 Sand	W567 Clay	W597 Wattle	
W5021 White Ice					

Whitecore Designer Mat Board • 32 x 40 (4 Ply) 1-24: **8.49** 25-49: **8.07** 50+: **7.64**

W1420 Onyx	W1796 Copper
------------	--------------

Whitecore Double Thick Mat Board • 32 x 40 1-24: **10.10** 25-49: **9.59** 50+: **9.08**

W521-DT Crystal White	W569-DT Sparkling White	W572-DT Chalk	W604-DT Teakwood Black
-----------------------	-------------------------	---------------	------------------------

Whitecore Giant Mat Board • 40 x 60 1-24: **13.61** 25-49: **12.93** 50+: **12.26**

WG61000 Digital White	WG65023 Royal Blue	WG6506 Cardinal Red	WG6552 Snow	WG6572 Chalk	WG6604 Teakwood Black
WG65001 Oatmeal	WG65028 Dusty Cream	WG6510 Winter White	WG6558 Dark Grey	WG6573 Venetian Blue	WG6621 Peregrine
WG65002 Cashew	WG65031 Midnight Black	WG6515 Terrace	WG6562 Cedar	WG6575 Chinese Red	WG6624 Sahara
WG65010 Soft Mauve	WG65034 Wine	WG6519 Dark Blue	WG6564 Art Brown	WG6578 Juniper	
WG65012 Beige	WG65035 Inspired White	WG6521 Crystal White	WG6565 Moss Green	WG6579 Soft White	
WG65013 Pearl	WG65037 Brite Red	WG6534 Raspberry	WG6568 Blueberry	WG6580 Beaver Brown	
WG65014 Glacier White	WG65040 London Grey	WG6538 Haze	WG6569 Sparkling White	WG6586 Dark Black	
WG65021 White Ice	WG65060 Cape Cod Grey	WG6549 Off White	WG6570 White	WG6597 Wattle	

Whitecore Double Thick Giant Mat Board • 40 x 60 1-24: **15.42** 25-49: **14.66** 50+: **13.88**

WG6521-D Crystal White	WG6569-D Sparkling White	WG6604-D Teakwood Black
------------------------	--------------------------	-------------------------

Whitecore Mat Board • 40 x 60 (4 Ply) 1-24: **20.30** 25-49: **19.30** 50+: **18.27**

WG61420 Onyx

Black Core Mat Board • 32 x 40 (4 Ply) 1-24: **7.57** 25-49: **7.19** 50+: **6.81**

B118 Lichen	B3023 Royal Blue	B315 Terrace	B370 White	B389 Porpoise	PB791 Mercury
B3001 Oatmeal	B3024 Real Red	B353 Pale Grey	B372 Chalk	B404 Teakwood Black	
B3021 White Ice	B3025 Blue Stone	B368 Blueberry	B377 Maroon	B781 Gold	
B3022 Burnt Orange	B305 Evergreen	B369 Sparkling	B378 Juniper	PB311 Silver White	

Whitecore Double Thick Black Core Mat Board • 40 x 60 (4 Ply) 1-24: **13.60** 25-49: **12.93** 50+: **12.25**

B3020 Onyx

• All prices shown are per sheet.

Black Core Giant Mat Board • 40 x 60 (4 Ply) 1-24: **18.62** 25-49: **17.69** 50+: **16.76**

BG6369 Sparkling White	BG6372 Chalk	BG6404 Teakwood Black
BG6370 White	BG6378 Juniper	BG6781 Gold

Conservation Mat Board • 32 x 40 (4 Ply) 1-24: **8.96** 25-49: **8.51** 50+: **8.07**

• White high alpha cellulose core that is free of acid, lignin, and ground wood • Fade and bleed resistant surface papers • Buffered to an alkaline pH
 • Contains no optical brighteners • Meets all Fine Art Trade Guild and Fine Art Care & Treatment standards

A109 TV Black	A4004 Antique Blue	A407 Mist	A4422 Burnt Orange	A446 Storm Grey	A479 Soft White
A150-153 White Wash / Cream	A4005 Pink	A408 Bluejay	A4423 Royal Blue	A448 Powder Blue	A480 Beaver Brown
A211 Dijon	A4006 Olive	A409 Brite White	A4424 Real Red	A449 Off White	A481 Bisque
A215 Talc	A4007 Ice Pink	A410 Winter White	A4425 Blue Stone	A451 Sunflower	A482 Plum
A217 Thistle	A4008 Blush	A411 Silver White	A443 Coffee	A452 Snow	A485 Trail
A218 Lichen	A4009 Celery	A412 Burgundy	A4435 Inspired White	A453 Pale Grey	A486 Dark Black
A219 Balsam	A4010 Soft Mauve	A414 Forest Green	A4436 Siberian White	A454 Nickel	A488 Maize
A220 Fathom	A4011 Victorian Rose	A415 Terrace	A4437 Brite Red	A456 Mocha	A489 Porpoise
A221 Peregrine	A4012 Beige	A416 Putty	A4438 Java	A457 Silver Grey	A491 Riviera Blue
A222 Azure	A4013 Pearl	A417 Cirrus	A4439 Blue Heron	A458 Dark Grey	A492 Antique
A223 Pacific	A4014 Glacier White	A422 Vanilla	A444 Rosewood	A460 Soft Grey	A494 Coral
A224 Sahara	A4015 African Violet	A423 Atlantic	A4440 London Grey	A461 Limoges	A495 Ivory
A225 Sierra	A4016 Dark Almond	A426 Tan	A4441 Egrit	A462 Cedar	A496 Pale Blue
A226 Saffron	A4017 Ginger	A427 Sapphire	A4442 Pumpkin	A463 Taupe	A497 Wattle
A227 Ash	A4019 Ocean Grey	A428 Aspen	A4443 Midnight Blue	A464 Art Brown	A499 Burnt Sienna
A228 Smoke	A4020 Tangerine	A431 Pumice	A4444 Shamrock	A465 Moss Green	A501 Feather Grey
A230 Cinnamon	A4026 Teal	A432 Flax	A4445 Persimmon	A466 Cadet Grey	A502 Charcoal Grey
A231 Apple Red	A4027 Wicker	A434 Raspberry	A4447 Lemon	A468 Blueberry	A504 Teakwood Black
A232 Peach	A4028 Dusty Cream	A435 Sand	A4448 Fern	A470 White	A819 Dark Blue
A233 Lavender	A4029 Buff	A438 Haze	A4449 Spruce	A471 Agate Grey	AC4881 Canvas White
A4000 Antique Rose	A403 Goldenrod	A440 Spring Green	A4450 Cloud Grey	A472 Chalk	AS421 Crystal White
A4001 Oatmeal	A4030 Clover	A441 Pecan	A4452 Overcast	A473 Venetian Blue	AS4471 Digital White
A4002 Cashew	A405 Evergreen	A442 Cognac	A4453 Sandstorm	A476 Silver Pine	
A4003 Caribbean Blue	A406 Cardinal Red	A4421 White Ice	A445 Rust	A478 Juniper	

A4446 Aztec Gold	A4793 Light Silver	1-24: 12.32	25-49: 11.71	50+: 11.10
A4781 Smooth Gold	A4794 Silver Splash			
A4782 Light Gold	A4795 Spun Gold			
A4791 Mercury	A4797 Gold Splash			

A4420 Onyx	A4796 Copper	1-24: 14.29	25-49: 13.56	50+: 12.85
------------	--------------	--------------------	---------------------	-------------------

Conservation Embossed Mat Board • 32 x 40 (4 Ply) 1-24: **9.04** 25-49: **8.60** 50+: **8.14**

A1304 Black Linen	A1401 Pebbled White	A160 White Eggshell
A1350 Linen White	A1409 Pebbled Black	A161 Light Cream Eggshell

Conservation Double Thick Mat Board • 32 x 40 1-24: **13.66** 25-49: **12.97** 50+: **12.29**

A452-DT Snow	A472-DT Chalk
A470-DT White	A504-DT Teakwood Black

Conservation Double Thick Giant Mat Board • 40 x 60 1-24: **28.20** 25-49: **26.78** 50+: **25.37**

AG6452-D Snow	AG6504-D Teakwood Black
---------------	-------------------------

Conservation Giant Mat Board • 40 x 60 (4 Ply) 1-24: **20.21** 25-49: **19.19** 50+: **18.19**

AG6150-6 White Wash/Cream	AG64010 Soft Mauve	AG6412 Burgundy	AG64437 Brite Red	AG6465 Moss Green	AG6504 Teakwood Black
AG6217 Thistle	AG64012 Beige	AG6414 Forest Green	AG64440 London Grey	AG6468 Blueberry	AG6819 Dark Blue
AG6221 Peregrine	AG64013 Pearl	AG6415 Terrace	AG6449 Off White	AG6470 White	AC64881 Canvas White
AG6224 Sahara	AG64014 Glacier White	AG6438 Haze	AG6452 Snow	AG6472 Chalk	ASG6421 Crystal White
AG6231 Apple Red	AG64028 Dusty Cream	AG64421 White Ice	AG6458 Dark Grey	AG6473 Venetian Blue	ASG64471 Digital White
AG64001 Oatmeal	AG6406 Cardinal Red	AG64423 Royal Blue	AG6462 Cedar	AG6479 Soft White	
AG64002 Cashew	AG6410 Winter White	AG64435 Inspired White	AG6464 Art Brown	AG6486 Dark Black	

AG6781 Smooth Gold	AG6791 Mercury	1-24: 25.75	25-49: 24.86	50+: 23.18
--------------------	----------------	--------------------	---------------------	-------------------

AG64420 Onyx	1-24: 29.45	25-49: 27.98	50+: 26.50
--------------	--------------------	---------------------	-------------------

AC64881 Canvas White	1-24: 19.65	25-49: 18.66	50+: 17.68
----------------------	--------------------	---------------------	-------------------

• All prices shown are per sheet.

Conservation Solid Core • 32 x 40 (4 Ply)				1-24: 11.14	25-49: 10.42	50+: 9.92
P4801-4	Natural	P4802-4	Classic White	P4803-4	Oxford White	

Conservation Solid Core • 40 x 60 (4 Ply)				1-24: 22.00	25-49: 20.55	50+: 19.59
P64801-4	Natural	P64802-4	Classic White	P64803-4	Oxford White	

Conservation Solid Core • 32 x 40 (8 Ply)				1-24: 18.24	25-49: 17.04	50+: 16.24
P4801-8	Natural	P4802-8	Classic White			

Conservation Solid Core • 40 x 60 (8 Ply)				1-24: 36.18	25-49: 33.81	50+: 32.22
P64801-8	Natural	P64802-8	Classic White			

Designer Silkscreen Mat Board • 32 x 40 (4 Ply)				1-24: 13.59	25-49: 12.91	50+: 12.23
--	--	--	--	--------------------	---------------------	-------------------

- Printed with lightfast bleed-resistant inks
- High quality white core
- Smooth bright white bevel
- All parts acid free and buffered
- Buffered to a pH of 8.0 to 9.5

DSK0101	Fresco Chalk	DSK0201	Venetian Plaster Ivory	DSK0301	Travertine Chalk
DSK0102	Fresco Vanilla	DSK0202	Venetian Plaster Talc	DSK0302	Travertine Vanilla
DSK0103	Fresco Haze	DSK0203	Venetian Plaster Powder	DSK0303	Travertine Haze
DSK0104	Fresco Maize	DSK0204	Venetian Plaster Sierra	DSK0304	Travertine Bisque
DSK0105	Fresco Nickel	DSK0205	Venetian Plaster Flax	DSK0305	Travertine Lichen
DSK0106	Fresco Rosewood	DSK0206	Venetian Plaster Feather Grey	DSK0306	Travertine Dark Green
DSK0107	Fresco Juniper	DSK0207	Venetian Plaster Juniper	DSK0307	Travertine Pecan
DSK0109	Fresco Beaver Brown	DSK0208	Venetian Plaster Beaver Brown	DSK0308	Travertine Walnut
DSK0110	Fresco Teakwood	DSK0209	Venetian Plaster Teakwood	DSK0310	Travertine Teakwood
DSK0111	Fresco Ebony			DSK0311	Travertine Nero

Designer Suede Mat Board • 32 x 40 (4 Ply)				1-24: 27.01	25-49: 25.66	50+: 24.32
---	--	--	--	--------------------	---------------------	-------------------

- High quality designer suede, rich in color with a dense luxurious flock
- Buffered to a pH of 8.0 to 9.5
- Conservation Core
- Clean extra thick bright white bevel

DS950	Black Suede	DS957	Royal Red Suede	DS964	Champagne Suede	DS971	Pine Suede
DS951	Navy Suede	DS958	Buckskin Suede	DS965	Dove Grey Suede	DS972	Bronze Suede
DS952	Hazelnut Suede	DS959	Latte Suede	DS966	Mint Green Suede	DS973	Sage Suede
DS953	Moss Green Suede	DS960	Chocolate Suede	DS967	Mushroom Suede	DS974	Admiral Blue
DS954	Emerald Suede	DS961	Gun Metal Suede	DS968	Slate Blue Suede	DS975	Sterling Suede
DS955	Pewter Suede	DS962	Royal Blue Suede	DS969	Gull Grey Suede	DS976	Red Rock
DS956	Bordeaux Suede	DS963	Camel Suede	DS970	White Suede	DS977	Navajo

Designer Suede Giant Mat Board • 40 x 60 (4 Ply)				1-24: 59.57	25-49: 56.59	50+: 53.61
---	--	--	--	--------------------	---------------------	-------------------

DSG6950	Black Suede	DSG6958	Buckskin Suede
DSG6951	Navy Suede	DSG6974	Admiral Blue Suede
DSG6956	Bordeaux Suede		

Designer Fabric Mat Board • 32 x 40 (4 Ply)						
--	--	--	--	--	--	--

- White high alpha cellulose core that is free of acid, lignin, and ground wood
- Fade and bleed resistant surface papers
- Buffered to an alkaline pH
- Contains no optical brighteners
- Meets all Fine Art Trade Guild and Fine Art Care & Treatment standards

DF926	Sharp White Linen	DF929	Chestnut Linen	DF9212	Eclipse Linen	1-24: 23.26	25-49: 21.73	50+: 20.72
DF927	Sesame Linen	DF9210	Nimbus Linen	DF9213	Eggplant Linen			
DF928	Acorn Linen	DF9211	Mako Linen	DF9214	Spinach Linen			

DF920	Ruby Linen	DF923	Ebony Linen	1-24: 26.43	25-49: 25.10	50+: 23.79
DF921	Gallery Linen	DF924	Dynasty Blue Linen			
DF922	Cream Linen	DF925	Brilliant White Linen			

DF900	Graphite Weave	DF902	Sterling Weave	DF904	Grey Weave	1-24: 31.17	25-49: 29.60	50+: 28.06
DF901	Slate Weave	DF903	Rattan Weave					

DF890	Valencia Linen	DF893	Malaga Linen	DF896	Madrid Linen	1-24: 31.22	25-49: 29.18	50+: 27.81
DF891	Seville Linen	DF894	Bilbao Linen	DF897	Cadiz Linen			
DF892	Vigo Linen	DF895	Alicante Linen	DF898	Barcelona Linen			

DF940	Shiro	DF942	Aka	DF944	Kuro	1-24: 36.01	25-49: 34.20	50+: 32.40
DF941	Shinju	DF943	Kon	DF945	Kaki			

• All prices shown are per sheet.

DF9010 Heritage Grey Weave	DF9013 Heritage Flint Weave	DF9016 Heritage Brown Weave	1-24: 36.21	25-49: 33.83	50+: 32.25
DF9011 Heritage Taupe Weave	DF9014 Heritage Sage Weave	DF9017 Heritage Black Weave			
DF9012 Heritage Nutmeg Weave	DF9015 Heritage Marine Weave				
DF880 Oat Natural	DF930 White Real Linen	DF934 Baja Real Linen	1-24: 37.80	25-49: 35.91	50+: 34.02
DF881 Buckwheat Natural	DF931 Snow Real Linen	DF935 Black Shadow Real Linen			
DF882 Barley Natural	DF932 Cream Real Linen	DF936 Java Real Linen			
DF883 Rye Natural	DF933 Mojave Real Linen				
DF9020 Paris White Crush	DF9022 Lisbon Port Crush		1-24: 45.96	25-49: 42.95	50+: 40.94
DF9021 Vienna Cream Crush	DF9023 Dover Mist Crush				
Designer Fabric Mat Board • 40 x 60 (4 Ply)			1-24: 79.01	25-49: 75.06	50+: 71.12
DFG6930 White Real Linen	DFG6932 Cream Real Linen				
DFG6931 Snow Real Linen	DFG6935 Black Shadow Real Linen				
DFG6921 Gallery Linen	DFG6926 Sharp White Linen		1-24: 55.37	25-49: 52.60	50+: 49.83
DFG6923 Ebony Linen	DFG69210 Nimbus Linen				
Museum Single Ply Mat Board • 32 x 40			1-24: 3.73	25-49: 3.55	50+: 3.35
M900-1 White 1 Ply					
Museum 2-Ply Mat Board • 32 x 40			1-24: 6.93	25-49: 6.58	50+: 6.23
M900-2 White 2 Ply					
Museum 4-Ply Mat Board • 32 x 40					
M907-4 Perfect White			1-24: 12.99	25-49: 12.34	50+: 11.69
M900-4 White	M903-4 Cream		1-24: 13.36	25-49: 12.69	50+: 12.02
M901-4 Warm White	M906-4 Soft Cream				
M902-4 Traditional White	M950-4 White (unbuffered)				
M908-4 Almond	M909-4 Grey		1-24: 13.73	25-49: 13.05	50+: 12.37
M904-4 Light Grey			1-24: 14.13	25-49: 13.42	50+: 12.72
M905-4 Black			1-24: 17.56	25-49: 16.68	50+: 15.80
Museum 8-Ply Mat Board • 32 x 40					
M907-8 Perfect White			1-24: 32.26	25-49: 30.64	50+: 29.02
M900-8 White	M902-8 Traditional White		1-24: 33.18	25-49: 31.51	50+: 29.85
M901-8 Warm White	M906-8 Soft Cream				
M905-8 Black			1-24: 43.28	25-49: 41.12	50+: 38.96
Museum Single Ply Giant Mat Board • 40 x 60			1-24: 8.60	25-49: 8.21	50+: 7.76
MG900-1 White					
Museum 2-Ply Giant Mat Board • 40 x 60			1-24: 15.17	25-49: 14.50	50+: 13.69
MG900-2 White					
Museum 4-Ply Giant Mat Board • 40 x 60					
MG907-4 Perfect White			1-24: 24.21	25-49: 23.00	50+: 21.79
MG900-4 White	MG902-4 Traditional	MG906-4 Soft Cream	1-24: 24.90	25-49: 23.65	50+: 22.41
MG901-4 Warm White	MG903-4 Cream				
MG904-4 Light Grey			1-24: 26.32	25-49: 25.00	50+: 23.68
MG905-4 Black			1-24: 32.36	25-49: 30.74	50+: 29.13
Museum 8-Ply Giant Mat Board • 40 x 60					
MG907-8 Perfect White			1-24: 60.30	25-49: 57.29	50+: 54.27
MG900-8 White	MG901-8 Warm White	MG902-8 Traditional White	1-24: 62.02	25-49: 58.92	50+: 55.83
Museum 4-Ply Oversize Mat Board					
M90172-4 Warm White Museum Jumbo • 48 x 72			1-24: 56.77	25-49: 53.94	50+: 51.09
M90072-4 White Museum Jumbo • 48 x 72			1-24: 58.40	25-49: 55.48	50+: 52.55
M90096-4 White Museum Jumbo • 48 x 96			1-24: 73.81	25-49: 70.12	50+: 66.43
M9001044 White Museum Jumbo • 60 x 104			1-24: 99.66	25-49: 94.67	50+: 89.68

• All prices shown are per sheet.

Mount Board • 32 x 40

910M	40-point Mount Board	1-24:	2.37	25-49:	2.25	50+:	2.14
920M	80-point Mount Board	1-24:	4.70	25-49:	4.46	50+:	4.22
5032	55-point Mount Board	1-24:	5.04	25-49:	4.80	50+:	4.54
5033	95-point Mount Board	1-24:	7.30	25-49:	6.93	50+:	6.57

Mount Board • 40 x 60

920G	80-point Mount Board	1-24:	8.15	25-49:	7.74	50+:	7.33
1092	95-point Mount Board	1-24:	13.11	25-49:	12.44	50+:	11.79

Needlepoint Mount Board • 32 x 40

R265-266	Needlepoint Mount Board	1-24:	9.90	25-49:	9.41	50+:	8.91
----------	-------------------------	-------	-------------	--------	-------------	------	-------------

Ultra Smooth 2-Sided Mount Board

950	50-point Mount Board 32 x 40	1-24:	8.33	25-49:	7.91	50+:	7.50
951	100-point Mount Board 32 x 40	1-24:	12.43	25-49:	11.80	50+:	11.19
952	50-point Mount Board 40 x 60	1-24:	15.14	25-49:	14.39	50+:	13.63
953	100-point Mount Board 40 x 60	1-24:	19.81	25-49:	18.81	50+:	17.82

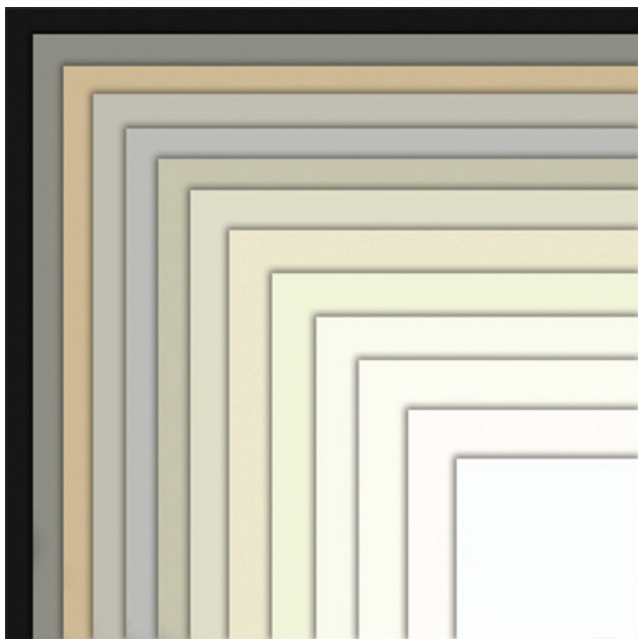

Rising Matboards

Rising boards were created by Rising Paper over 50 years ago to supply museums' demands for a true conservation and preservation framing board. Over the years, in conjunction with Legion Paper, Rising Paper expanded the range into a family of museum boards known for its exceptional and unmatched quality. Today, under the stewardship of Legion Paper, Rising is the industry standard used to frame all the great masterpieces.

Rising is a range of acid-free museum board, conservation board and artist drawing papers used by the finest museums, galleries and framers worldwide. The Rising family of boards consists of a focused color palette of white, off-whites, greys and black to complement all works of art. The colors are solid throughout and will not fade, scuff or bleed. Rising is also the only manufacturer to offer a range of oversize boards measuring up to 60" x 104" to frame those exceptionally large pieces.

The preservation characteristics of Rising make it the ideal matting and mounting solution for fine art. Its superior cutting quality makes for an ultra-sharp and clean bevel to enhance the framed art. The rigid quality control ensures consistency across the range producing a board free of specs, dirt or blemishes. Rising exceeds the standards set by the Library of Congress.

Rising Museum Board

Rising Museum Mounting Board is the first choice of framers, museums and conservators for the mounting, matting and preservation of fine prints and precious documents. Rising Museum Boards consist of 14 colors and manufactured with 100% cotton. The boards are acid-free, Neutral pH and buffered with calcium carbonate. Rising boards are sized for French matting and many artists use the boards for various fine art techniques such as drawing, charcoal, pastel, and silkscreening.



The cotton used to manufacture Rising Museum Boards is not from the puffy white flower that we all recognize as cotton, but rather the linters, or byproduct, from the textile industry. Textiles are made using the longest, highest-quality fibers – the rest is discarded. This wasted cotton is salvaged and used to manufacture Rising Museum Boards. Nothing could be more eco-friendly than reusing a product that is considered waste – otherwise this would all end up in the trash.

• 100% Cotton

Cotton is naturally lignin-free. One hundred percent rag is used to produce all Rising Museum Board. The result is a board that provides matchless quality and extraordinary preservation characteristics. Rag papers have survived the test of time.

• Acid Free

Rising Board is made with a minimum pH of 7 and is acid-free. No alum is used in the entire papermaking process. The single ply sheets are laminated together using an inert adhesive that is 100% acid-free and archival.

• Buffered

All Rising boards are buffered with a minimum 3% calcium carbonate (except the Photomount papers, which have no calcium carbonate buffering) as required by the U.S. Library of Congress to protect the board from hostile environmental factors.

• Pigments

Only the finest pigments are used in the manufacturing process to ensure that all the colors will not bleed nor fade. The lightfast colors are solid throughout and are fixed into the fiber. Each run of Museum Board is matched to a stored color sample and controlled using computerized color measurement and trained color technicians.

• Rigid Quality Control & Consistency

Rising Board is continuously tested during the manufacturing process by both computer and manual controls to ensure conformance to the TAPPI and ASTM specifications required by the archival community.

• Superior Cutting

No other board cuts as precisely as Rising to produce an ultra-sharp and clean bevel. To ensure this quality all plys are from the same quality and caliber with consistent density throughout.

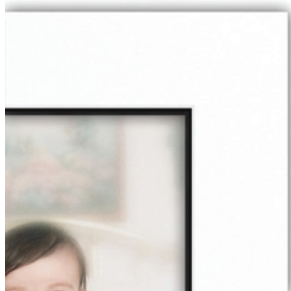

Rising Conservation Matboard

Rising Conservation Board combines the permanence of our Rising Museum Board with the affordability of a wood pulp board. These acid and lignin-free boards are suitable for both fine art and photographic pieces. Rising Conservation Board is relatively inexpensive and designed for extended longevity.



Rising Photomount

This non-buffered board is recommended for photographic and other uses where the usual alkaline environment of buffered mounting is considered undesirable. Since the board is not buffered, a slight drop in pH value is expected when exposed to normal atmospheric conditions.

• All prices shown are per sheet.

RIISING CONSERVATION BOARD (4 PLY) • 32 x 40				1-9: 9.15	10-49: 8.69	50+: 7.78	
R625	Ivory	R403026	White	R403126	Snow White	R403226	Antique
RIISING CONSERVATION BOARD (4 PLY) • 40 x 60				1-9: 17.16	10-24: 16.29	25+: 14.57	
R403028	White						
RIISING MUSEUM BOARD (2 PLY) • 32 x 40				1-9: 6.93	10-99: 6.58	100+: 5.89	
R401952	White	R401953	Natural	R403198	Warm White	R405601	Antique
R403025	White	R403125	Snow White			R405901	Polar White
						1-99: 6.80	100+: 4.23
R401951	Medium Gray			1-9: 7.67	10-99: 7.29	100+: 6.52	
R405630	Black			1-9: 9.12	10-99: 8.67	100+: 7.76	
RIISING MUSEUM BOARD (2 PLY) • 40 x 60				1-9: 12.95	10-49: 12.30	50+: 11.01	
R401755	White						
RIISING MUSEUM BOARD (4 PLY) • 32 x 40				1-9: 13.85	10-49: 13.17	50+: 11.78	
R401956	Natural	R402872	White	R405602	Antique	R405902	Polar White
R402447	Warm White	R405420	Ivory	R405720	Olde White	R400906	Cream
R400975	Zinc	R405620	Medium Grey			1-9: 14.67	10-49: 13.93
R405454	Fawn	R405730	Neutral Grey				50+: 12.47
R405820	Black			1-9: 18.28	10-49: 17.37	50+: 15.54	
RIISING MUSEUM BOARD (4 PLY) • 40 x 60				1-9: 25.98	10-24: 24.66	25+: 22.08	
R400908	Cream	R402490	White	R405721	Olde White	R405903	Polar White
R402487	Natural	R405603	Antique	R403196	Warm White		
R400974	Zinc			1-9: 27.52	10-24: 26.16	25+: 23.39	
R405821	Black			1-9: 34.32	10-24: 32.61	25+: 29.19	
RIISING MUSEUM BOARD (4 PLY) • 48 x 72				1-4: 57.38	5-19: 54.52	20+: 48.78	
R401810	White	R401820	Warm White				
R402875	Black			1-4: 67.12	5-19: 63.72	20+: 56.99	
RIISING MUSEUM BOARD (4 PLY) • 48 x 96				1-4: 76.84	5-9: 73.01	10+: 65.32	
R401705	White	R401805	Warm White				
RIISING MUSEUM BOARD (4 PLY) • 60 x 104				1-4: 103.70	5-9: 98.51	10+: 88.15	
R401722	Antique	R402873	White	R460104	Warm White		
R402874	Black			1-4: 118.86	5-9: 112.92	10+: 101.03	
RIISING MUSEUM BOARD (8 PLY) • 32 x 40				1-9: 34.88	10-19: 33.13	20+: 29.64	
R401700	White	R401720	Antique	R405904	Polar White		
R401710	Warm White	R401730	Natural				
RIISING MUSEUM BOARD (8 PLY) • 40 x 60				1-4: 65.55	5-9: 62.28	10+: 55.72	
R401701	White	R401721	Antique	R405905	Polar White		
R401711	Warm White	R401731	Natural				
RIISING MUSEUM BOARD (8 PLY) • 48 x 72				1-4: 145.21	5-9: 135.38	10+: 121.13	
R401815	White						
R401825	Warm White						
RIISING PHOTOMOUNT BOARD (4 PLY)							
RPHW3240	32 x 40 4 Ply Photomount			1-9: 13.85	10-49: 13.17	50+: 11.78	
RPHW4060	40 x 60 4 Ply Photomount			1-9: 25.998	10-24: 24.66	25+: 22.08	

• Volume & Contract Matboard

BERKSHIRE

Matting

Berkshire Matboards

Berkshire matboard meets the continually evolving demand for creating framed wall décor with on trend style and sophistication that complements any art style. The Berkshire product line was specifically designed for the needs of the larger volume wall décor manufacturer. Take advantage of a palette with over 300 vivid colors and richly printed patterns – a palette that provides unparalleled creative and design flexibility. Home decor trends are constantly evolving. Designers need to be one step ahead of what's new and what's now. Berkshire products meet the growing demand for matting with a style and sophistication that complements any artwork. Berkshire brings you the latest in style and design with the industry's largest color palette, all backed by the quality of Crescent. Everything you need to make your art extraordinary.

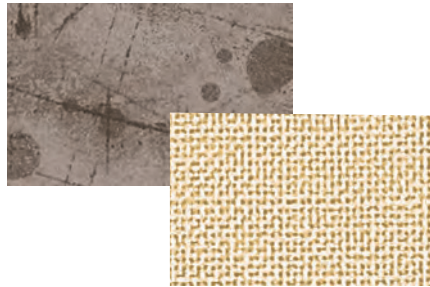
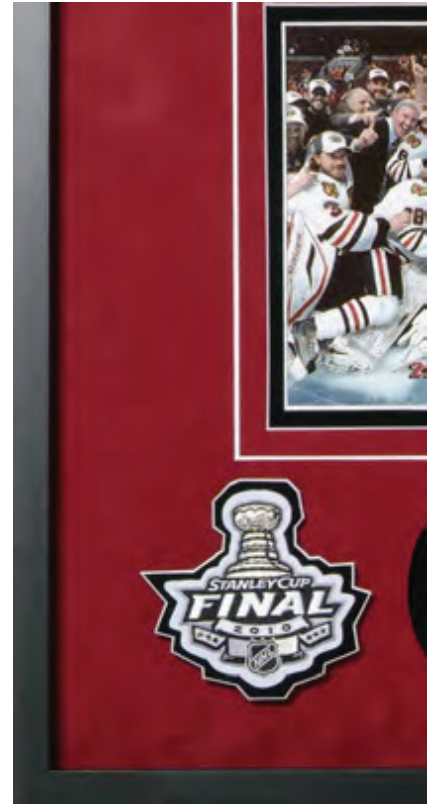

• Color

Take advantage of a collection of over 250 vivid colors and richly printed patterns; a palette that provides unparalleled creative and design flexibility.

• Patterns

Our innovative collection of printed and patterned matboards is unrivaled in the industry. From subtle earthy patterns to bold geometrics, you'll find an inspirational collection to add depth and texture to your framing designs.

• Suedes

Our premium fabric surfaces feature solid white eco-core™ (100% recycled core). Available in 22 popular colors, with a richness and depth that is unmatched in the contract market. Great for sports memorabilia, as well as traditional and contemporary décor.

*at the variety
core*

In addition to standard cream core, Berkshire also offers the following on-trend core options:

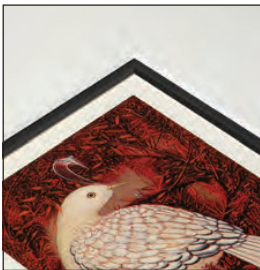

Berkshire Gallery Board

White Core (eco-core™): The bright white core material used on these products is comprised of 100% recycled fiber, making eco-core among the most environmentally friendly boards in the contract market. Choose from over 60 eco-core items, including solid colors, sports mats and suedes.

Black Core: Choose from six popular and versatile surface colors and textures, with dramatic black core for extra depth and detail.

Gallery Board: Get the museum look of Double Thick and Triple Thick solid color boards for the contract market. Customers will love this premium look, which is high on style at a value price.

Be assured that every Berkshire matboard, regardless of the core material, is buffered to be pH neutral.

▲ California Customers- WARNING: Cancer and Reproductive Harm - www.P65Warnings.ca.gov

• Berkshire Matboards sold only by the box (25 sheets per box); All prices shown are per sheet.

BERKSHIRE BASICS • 32 x 40 (4 ply) **1 Box Price (per sheet): \$ 2.12**

CB038 Maroon	CB222 Smooth White	CB403 Pure White	CB524 Hunter Green
CB97 Polar White	CB334 Bottle Blue	CB461 Crisp	CBX501 Papyrus
CB221 Smooth Black	CB402 White	CB508 Ecru	

CB161 Granite	CB551 Mulberry	CB555 Burnt Sienna	1 Box Price (per sheet): \$ 2.16
---------------	----------------	--------------------	---

BERKSHIRE BASICS • 33 x 42 (4 ply) **1 Box Price (per sheet): \$ 2.75**

CB22142 Smooth Black
CB22242 Smooth White

BERKSHIRE BASICS • 40 x 60 (4 ply) **1 Box Price (per sheet): \$ 5.53**

CB8-038 Maroon	CB8-222 Smooth White	CB8-403 Pure White	CB8-524 Hunter Green
CB8-97 Polar White	CB8-334 Bottle Blue	CB8-461 Crisp	CB8-X501 Papyrus
CB8-221 Smooth Black	CB8-402 White	CB8-508 Ecru	

BERKSHIRE STANDARDS • 32 x 40 (4 ply) **1 Box Price (per sheet): \$ 2.32**

CB79 Yorktown Blue	CB151 Soft Pink	CB453 Dark Olive	CB523 Grass	CB569 Cinder
CB84 Grape	CB152 Tangerine	CB455 Aqua Blue	CB529 Honeydew	CB571 Pitch
CB106 Weatherwood	CB163 Oyster Shell	CB459 Deep Red	CB531 Aquamarine	CB572 Black Pebble
CB110 Buttercup	CB169 Bamboo	CB462 Glow	CB534 Fountain Blue	CB579 Sand Castle
CB115 Hazelnut	CB235 Chamois	CB473 Topaz	CB536 Clapboard	CB703 Marzipan
CB116 Monastery	CB239 Toasted Almond	CB500 Canvas	CB539 Antique Blue	CB706 Loam
CB126 French Vanilla	CB248 Sea Green	CB501 White & Cream	CB544 Cobalt	CB709 Sabbia
CB130 Silver Mist	CB251 Antique White	CB502 Cloud	CB546 Ink	CB710 Aged Oak
CB131 Midnight Blue	CB252 Cappuccino	CB504 Buff	CB547 Amethyst	CB718 Valley Green
CB132 Mojave	CB253 Pale Laurel	CB505 White & Cream Pebble	CB548 Pansy	CB752 Magnolia
CB133 Seashell	CB351 Oyster Bay	CB506 Sailcloth	CB552 Merlot	CB771 Pure Gray
CB139 Chestnut	CB357 Rattan	CB507 Soft Cream	CB558 Tawny	CB772 Dover White
CB143 Bay Blue	CB358 Dill	CB511 Beige	CB559 Fig	CB797 Beach
CB146 Sea Foam	CB361 Pistachio	CB513 Plume	CB563 Sorrel Brown	
CB147 Moss	CB404 Textured Black	CB514 Seaside	CB564 Clay	
CB148 Herbal	CB407 Cream Linen	CB516 Heritage Gray	CB567 Cobblestone	

BERKSHIRE STANDARDS • 40 x 60 (4 ply) **1 Box Price (per sheet): \$ 5.53**

CB8-106 Weatherwood	CB8-139 Chestnut	CB8-235 Chamois	CB8-459 Deep Red	CB8-558 Tawny
CB8-126 French Vanilla	CB8-146 Sea Foam	CB8-251 Antique White	CB8-502 Cloud	CB8-569 Cinder
CB8-131 Midnight Blue	CB8-163 Oyster Shell	CB8-358 Dill	CB8-514 Seaside	

BERKSHIRE PREMIUMS • 32 x 40 (4 ply) **1 Box Price (per sheet): \$ 2.61**

CB96 Alpine	CB165 Raspberry	CB522 Palm	CB538 Brittany Blue	CB557 Autumn
CB102 Hollyhock	CB350 Hay	CB525 Olive	CB540 Lagoon	CB560 Chocolate
CB120 Purple Iris	CB450 Spice	CB526 Celtic	CB541 Steel Blue	CB561 Bordeaux
CB125 Spruce	CB452 Umber	CB527 Bright Green	CB542 Blue	CB562 Dark Brown
CB127 Forest Shadow	CB464 Splash	CB528 Jade	CB545 Deep Blue	CB565 Terrazzo
CB140 Lilac	CB509 Oat	CB530 Everglade	CB549 Lavender	CB566 Felt
CB153 Brick	CB517 Dune	CB532 Reef	CB550 Cardinal	CB570 Mocha
CB155 Pumice	CB518 Pear	CB533 Ocean Blue	CB553 Bittersweet	CB700 Carnelian
CB160 Harbor	CB519 Soft Yellow	CB535 Gray	CB554 Chili	CB802 Mid Gray
CB164 Heron	CB520 Golden	CB537 Bluestone	CB556 Terra-cotta	CB803 Eclipse

BERKSHIRE PREMIUMS • 40 x 60 (4 ply) **1 Box Price (per sheet): \$ 6.94**

CB8-450 Spice	CB8-518 Pear	CB8-550 Cardinal	CB8-557 Autumn	CB8-802 Mid Gray	CB8-803 Eclipse
---------------	--------------	------------------	----------------	------------------	-----------------

BERKSHIRE MATBOARD

• Volume & Contract Matboard

• Berkshire Matboards sold only by the box (25 sheets per box); All prices shown are per sheet.

BERKSHIRE WHITE CORE BASICS • 32 x 40 (4 ply) 1 Box Price (per sheet): \$ 2.83

CBW038 Maroon CBW221 Smooth Black CBW334 Bottle Blue CBW508 Ecru CBWX501 Papyrus
CBW97 Polar White CBW222 Smooth White CBW402 White CBW524 Hunter Green

BERKSHIRE WHITE CORE BASICS • 40 x 60 (4 ply) 1 Box Price (per sheet): \$ 7.48

CBW8-97 Polar White CBW8-221 Smooth Black CBW8-222 Smooth White CBW8-334 Bottle Blue

BERKSHIRE WHITE CORE STANDARDS • 32 x 40 (4 ply) 1 Box Price (per sheet): \$ 3.37

CBW106 Weatherwood CBW152 Tangerine CBW252 Cappuccino CBW453 Dark Olive CBW534 Fountain Blue
CBW110 Buttercup CBW163 Oyster Shell CBW253 Pale Laurel CBW455 Aqua Blue CBW558 Tawny
CBW131 Midnight Blue CBW169 Bamboo CBW357 Rattan CBW459 Deep Red CBW569 Cinder
CBW133 Seashell CBW239 Toasted Almond CBW358 Dill CBW502 Cloud CBW706 Loam
CBW148 Herbal CBW251 Antique White CBW361 Pistachio CBW516 Heritage Gray CBW710 Aged Oak
CBW718 Valley Green

BERKSHIRE WHITE CORE STANDARDS • 40 x 60 (4 ply) 1 Box Price (per sheet): \$ 8.26

CBW8-106 Weatherwood CBW8-251 Antique White CBW8-558 Tawny

BERKSHIRE WHITE CORE PREMIUMS • 32 x 40 (4 ply) 1 Box Price (per sheet): \$ 3.73

CBW120 Purple Iris CBW450 Spice CBW517 Dune CBW534 Fountain Blue CBW538 Brittany Blue CBW802 Mid Gray
CBW127 Forest Shadow CBW452 Umber CBW518 Pear CBW535 Gray CBW556 Terra-cotta

BERKSHIRE WHITE CORE PREMIUMS • 40 x 60 (4 ply) 1 Box Price (per sheet): \$ 9.22

CBW8-535 Gray CBW8-802 Mid Gray

BERKSHIRE BLACK CORE BASICS • 32 x 40 (4 ply) 1 Box Price (per sheet): \$ 2.83

CB6-97 Polar White CB6-277 Smooth Black

BERKSHIRE BLACK CORE BASICS • 40 x 60 (4 ply) 1 Box Price (per sheet): \$ 7.48

CB86-97 Polar White CB86-277 Smooth Black

BERKSHIRE BLACK CORE PREMIUMS • 32 x 40 (4 ply) 1 Box Price (per sheet): \$ 3.73

CB6-450 Spice

BERKSHIRE STANDARD METALLICS • 32 x 40 (4 ply) 1 Box Price (per sheet): \$ 3.51

CB472 Silver CB5-570 Gold
CB577 Classic Gold

BERKSHIRE STANDARD METALLICS • 40 x 60 (4 ply) 1 Box Price (per sheet): \$ 9.10

CB8-577 Classic Gold

BERKSHIRE WHITE CORE STANDARD METALLICS • 32 x 40 (4 ply) 1 Box Price (per sheet): \$ 4.83

CBW472 Silver
CBW577 Classic Gold

BERKSHIRE COLOR TRENDS • 32 x 40 (4 ply) 1 Box Price (per sheet): \$ 4.28

CBW800 Hot Pink

• Berkshire Matboards sold only by the box (25 sheets per box); All prices shown are per sheet.

BERKSHIRE PREMIUM METALLICS • 32 x 40 (4 ply) **1 Box Price (per sheet): \$ 4.18**

CB573 Graphite	CB575 Gold Foil	CB5-075 Frosted Gold
CB574 Silver Foil	CB5-074 Frosted Silver	CB5-149 Gold Relic

BERKSHIRE PREMIUM METALLICS • 40 x 60 (4 ply) **1 Box Price (per sheet): \$12.62**

CB85-074 Frosted Silver

BERKSHIRE PRINTED SURFACES BASICS • 32 x 40 (4 ply) **1 Box Price (per sheet): \$ 4.68**

• Decorative surface, solid cream core and backing

CB503 White Silk	CB515 Off White Silk	CB576 Gold Silk
CB512 Cream Silk	CB521 Green Silk	

BERKSHIRE PRINTED SURFACES STANDARDS • 32 x 40 (4 ply) **1 Box Price (per sheet): \$ 5.61**

• Decorative surface, solid cream core and backing

CB7-119 Rust	CB7-154 Taupe	CB7-163 Loden	CB7-174 Bronze
CB7-120 Brown	CB7-155 Brown	CB7-167 Cream	CB7-175 Khaki
CB7-150 Off White	CB7-156 Charcoal	CB7-169 Sauterne	CB7-713 Inca Gold
CB7-151 Cream	CB7-162 Sand	CB7-173 Olive	CB7-721 Tuscano

BERKSHIRE PRINTED SURFACES PREMIUMS • 32 x 40 (4 ply) **1 Box Price (per sheet): \$ 5.50**

CB7-245 Bruxelles
CB7-246 Antwerpen
CB7-700 Lounge (29 1/2" X 40")

BERKSHIRE PRINTED SURFACES PREMIUMS • 32 x 40 (4 ply) **1 Box Price (per sheet): \$ 6.45**

• Decorative surface, solid cream core and backing

CB7-198 Distressed - Gold	CB7-277 Morocco Black	CB7-437 Casa Blanca Brown	CB7-443 Sea Glass Beryl
CB7-254 Sheer Silk - Sand	CB7-278 Morocco Mulberry	CB7-439 Casa Blanca Ivory	CB7-725 Burnished Metals-Bronze Plated
CB7-255 Sheer Silk - Warm Green	CB7-400 Burl	CB7-440 Sea Glass Ice	CB67-400 Burl (Black Core)
CB7-274 Empire Stripes Black	CB7-401 Maple	CB7-441 Sea Glass Milk	
CB7-276 Empire Stripes White	CB7-436 Casa Blanca Black		

BERKSHIRE LINENS • 32 x 40 **1 Box Price (per sheet): \$ 5.50**

CB7-284 White Linen	CB7-288 Navy Linen
CB7-285 Khaki Linen	CB7-289 Green Linen
CB7-286 Brown Linen	CB7-290 Burgundy Linen
CB7-287 Black Linen	

BERKSHIRE LINENS • 40 x 60 **1 Box Price (per sheet): \$ 11.28**

CB87-245 Antwerpen	CB87-286 Brown Linen
CB87-246 Bruxelles	CB87-287 Black Linen
CB87-284 White Linen	

BERKSHIRE GALLERY BOARD • Double Thick (.090) 32 x 40 **1 Box Price (per sheet): \$ 5.83**

• Extra thick, solid color throughout

CB90B Black - DT (.090)
CB90C Cream - DT (.090)
CBSRM90 White - DT (.090)

BERKSHIRE GALLERY BOARD • Triple Thick (.130) 32 x 40 **1 Box Price (per sheet): \$ 8.49**

• Extra thick, solid color throughout

CB130B Black - TT (.130)
CB130C Cream - TT (.130)
CBSRM130 White - TT (.130)

BERKSHIRE GALLERY BOARD • Double Thick (.090) 40 x 60 **1 Box Price (per sheet): \$ 12.37**

• Extra thick, solid color throughout

CBSRM890 White - DT (.090)	CB890C Cream - DT (.090)
----------------------------	--------------------------

• *Volume & Contract Matboard*

• Berkshire Matboards sold only by the box (25 sheets per box); All prices shown are per sheet.

BERKSHIRE SPORTS MATS • 32 x 40 (4 ply)

1 Box Price (per sheet): \$ 10.05

• *Decorative dimensional surface, complementary core and backing*

CB62-100 Basketball (black core) CB62-103 Gloss Black (black core)
 CB62-101 Football (black core) CBW2-102 Golf Ball (white core)

BERKSHIRE WHITE CORE PREMIUM SUEDE • 32 x 40 (4 ply)

1 Box Price (per sheet): \$ 11.98

• *Fabric surface, solid white core and backing*

CB9-124 Royal Blue	CB9-130 Pine	CB9-136 Firelight	CB9-142 Night Sky
CB9-125 Winter	CB9-131 Downpour	CB9-137 Thicket	CB9-143 Cocoa
CB9-126 Grassland	CB9-132 Brook	CB9-138 Prairie	CB9-144 Sunrise
CB9-127 Leaf	CB9-133 Torrent	CB9-139 Twig	CB9-145 Clementine
CB9-128 Grove	CB9-134 Berry	CB9-140 Smoke	CB9-146 Red Sky
CB9-129 Treeline	CB9-135 Blaze	CB9-141 Ash	CB9-148 Crocus

BERKSHIRE WHITE CORE PREMIUM SUEDE • 40 x 60 (4 ply)

1 Box Price (per sheet): \$ 32.27

• *Fabric surface, solid white core and backing*

CB89-129 Treeline CB89-141 Ash
 CB89-133 Torrent CB89-142 Night Sky
 CB89-135 Blaze
 CB89-137 Thicket



Hampton Matboards

Hampton Matboards has been developed from 100 years of Matboard experience and expertise. This understanding has allowed us to provide products specially designed for high-volume users at prices that remain globally competitive. Hampton is a cost effective choice for those who desire high-quality, clean results and a board that is easy to handle. Made with a buffered alkaline pH this sturdy board creates a crisp and smooth finish that lasts. Featuring even color coverage, Hampton Matboard is available in a range of popular mounting colors to match the look you're after. A great option for those larger jobs that require an efficient, reliable and affordable solution.



- *Bright White Core*
- *Easy-to-cut, producing a crisp clean bevel*
- *Buffered to an alkaline pH (7.5 to 9.5)*
- *High quality surface papers with smooth even coloration*
- *50 point (1.2mm) thick*
- *32" x 40" (812 x 1016mm)*
- *40" x 60" (1016 x 1524mm) now available*

- *Hampton Matboards are available in 34 popular colours sized 32"x40", and in both whitecore and regular cream core.*
- *Fully customized runs available (thickness, length).*
- *Also can be cut to size, in 25 sheet boxes, or bulk on a skid.*

Hampton Matboards • A great value for volume Picture Framers

▲ California Customers- WARNING: Cancer and Reproductive Harm - www.P65Warnings.ca.gov

• All prices shown are per sheet.

HAMPTON MATBOARD • 32 x 40

Sold by the box only (volume mat line) • **Price Per Sheet: \$2.51**

H3000	Ultimate White	H3004	China White
H3001	Plain White	H3005	Sand Stone
H3002	Old White	H3100	Jet Black
H3003	Bone		

HAMPTON MATBOARD • 32 x 40

Sold by the box only (volume mat line) • **Price Per Sheet: \$2.72**

H3099	Natural Parchment	H3300	Pine	H3403	Dolphin	H3501	Wine
H3101	Shell	H3301	Slate	H3405	Espresso	H3502	Fire
H3102	Deep Grey	H3302	Cricket Green	H3406	Plaster	H3600	Straw
H3103	Flagstone	H3303	Sea Foam	H3407	Concrete		
H3104	Blue Grey	H3304	Sage	H3408	Hazelnut		
H3200	Navy Blue	H3400	Dark Chocolate	H3409	Putty		
H3202	Slate Blue	H3401	Light Sand	H3410	Desert		
H3203	Royal Blue	H3402	Pebble	H3500	Red		

HAMPTON SUEDE MATBOARD • 32 x 40

5 Sheets: **16.92** per sheet

20+: **13.09** per sheet

HS7600	Coal Suede	HS7603	Golf Green Suede	HS7606	Fawn Suede
HS7601	Cobalt Suede	HS7604	Burgundy Suede	HS7607	Dark Blue Suede
HS7602	Doe Suede	HS7605	Red Suede		

OMEGA

VOLUME & CONTRACT MATBOARD

Sold by the box only (volume mat line)

• All prices shown are per sheet.

Acid Free • White Core

OMEGA MATBOARD • 32 x 40

1 Box/ 25 sheets: **2.74** per sheet

5 Boxes: **2.58** per sheet

10+: **2.42** per sheet

OMM5000	Snow White	OMM5100	Coal Black	OMM5500	Red
OMM5001	Pearl White	OMM5200	Navy Blue	OMM5501	Merlot
OMM5002	Antique Ivory	OMM5302	Deep Moss	OMM5600	Sunshine
OMM5005	Vanilla Cream	OMM5400	Mocha		

Acid Free • White Core

OMEGA SUEDE MATBOARD • 32 x 40

1 Box/ 25 sheets: **12.11** per sheet

5 Boxes: **11.38** per sheet

10+: **10.98** per sheet

OMS7600	Black Suede
---------	-------------

NIELSEN ALUMINUM MOULDINGS

★ Nielsen Aluminum Mouldings are shipped from Omega in San Francisco

• Prices shown per linear foot

nielsen®

The Nielsen range of profiles and colors offers endless opportunities for creating unique framing designs. Modern, linear and lightweight, aluminium framing is an ideal choice for simple, clean presentations.

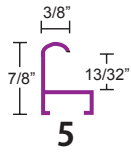

Item #	Color / Finish	List	300+	500+	Chop
N05-01	SILVER	\$1.95	\$1.75	\$1.66	\$3.07
N05-02	FROSTED SILVER	\$1.95	\$1.75	\$1.66	\$3.07
N05-03	GOLD	\$1.95	\$1.75	\$1.66	\$3.07
N05-04	FROSTED GOLD	\$1.95	\$1.75	\$1.66	\$3.07
N05-19	FROSTED WALNUT	\$2.26	\$2.03	\$1.92	\$3.56
N05-20	ANODIC BLACK	\$2.26	\$2.03	\$1.92	\$3.56
N05-21	MATTE BLACK	\$2.26	\$2.03	\$1.92	\$3.56
N05-50	BLACK	\$1.95	\$1.75	\$1.66	\$3.07

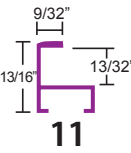

Item #	Color / Finish	List	300+	500+	Chop
N11-01	SILVER	\$1.95	\$1.75	\$1.66	\$3.07
N11-02	FROSTED SILVER	\$1.95	\$1.75	\$1.66	\$3.07
N11-03	GOLD	\$1.95	\$1.75	\$1.66	\$3.07
N11-04	FROSTED GOLD	\$1.95	\$1.75	\$1.66	\$3.07
N11-08	FROSTED BRONZE	\$2.26	\$2.03	\$1.92	\$3.56
N11-10	GRAPHITE	\$2.26	\$2.03	\$1.92	\$3.56
N11-11	PEWTER	\$2.26	\$2.03	\$1.92	\$3.56
N11-12	FROSTED PEWTER	\$2.26	\$2.03	\$1.92	\$3.56
N11-13	CONTRAST GREY	\$2.26	\$2.03	\$1.92	\$3.56
N11-14	GERMAN SILVER	\$2.26	\$2.03	\$1.92	\$3.56
N11-150	FLORENTINE SILVER	\$2.28	\$2.05	\$1.94	\$3.65
N11-155	FLORENTINE AMBER	\$2.28	\$2.05	\$1.94	\$3.65
N11-154	FLORENTINE GREY	\$2.28	\$2.05	\$1.94	\$3.65
N11-156	FLORENTINE BLACK	\$2.28	\$2.05	\$1.94	\$3.65
N11-169	SILVER MOSS	\$2.26	\$2.03	\$1.92	\$3.56
N11-18	WALNUT	\$2.26	\$2.03	\$1.92	\$3.56
N11-20	ANODIC BLACK	\$2.26	\$2.03	\$1.92	\$3.56
N11-21	MATTE BLACK	\$2.26	\$2.03	\$1.92	\$3.56
N11-23	ANTIQUÉ GOLD	\$1.95	\$1.75	\$1.66	\$3.07
N11-40	WHITE	\$1.95	\$1.75	\$1.66	\$3.07
N11-50	BLACK	\$1.95	\$1.75	\$1.66	\$3.07

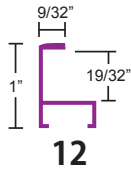

Item #	Color / Finish	List	300+	500+	Chop
N12-01	SILVER	\$2.26	\$2.03	\$1.92	\$3.57
N12-02	FROSTED SILVER	\$2.26	\$2.03	\$1.92	\$3.57
N12-14	GERMAN SILVER	\$2.54	\$2.28	\$2.16	\$4.04
N12-21	MATTE BLACK	\$2.54	\$2.28	\$2.16	\$4.04

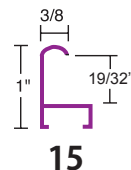

Item #	Color / Finish	List	300+	500+	Chop
N15-01	SILVER	\$2.15	\$1.93	\$1.83	\$3.41
N15-02	FROSTED SILVER	\$2.15	\$1.93	\$1.83	\$3.41
N15-03	GOLD	\$2.15	\$1.93	\$1.83	\$3.41
N15-04	FROSTED GOLD	\$2.15	\$1.93	\$1.83	\$3.41
N15-05	PALE GOLD	\$2.15	\$1.93	\$1.83	\$3.41
N15-06	FROSTED TAUPE	\$2.42	\$2.17	\$2.05	\$3.84
N15-08	FROSTED BRONZE	\$2.42	\$2.17	\$2.05	\$3.84
N15-10	GRAPHITE	\$2.42	\$2.17	\$2.05	\$3.84
N15-101	BURGUNDY	\$2.15	\$1.93	\$1.83	\$3.41
N15-11	PEWTER	\$2.42	\$2.17	\$2.05	\$3.84
N15-12	FROSTED PEWTER	\$2.42	\$2.17	\$2.05	\$3.84
N15-13	CONTRAST GREY	\$2.42	\$2.17	\$2.05	\$3.84
N15-14	GERMAN SILVER	\$2.42	\$2.17	\$2.05	\$3.84
N15-153	FLORENTINE PEWTER	\$2.53	\$2.27	\$2.15	\$4.00
N15-154	FLORENTINE GREY	\$2.53	\$2.27	\$2.15	\$4.00
N15-155	FLORENTINE AMBER	\$2.53	\$2.27	\$2.15	\$4.00
N15-156	FLORENTINE BLACK	\$2.53	\$2.27	\$2.15	\$4.00
N15-150	FLORENTINE SILVER	\$2.53	\$2.27	\$2.15	\$4.00
N15-151	FLORENTINE GOLD	\$2.53	\$2.27	\$2.15	\$4.00
N15-169	SILVER MOSS	\$2.42	\$2.17	\$2.05	\$3.84
N15-165	FLORENTINE BRASS	\$2.53	\$2.27	\$2.15	\$4.00
N15-164	DUSK	\$2.42	\$2.17	\$2.05	\$3.84
N15-162	AUTUMN BRONZE	\$2.42	\$2.17	\$2.05	\$3.84
N15-16	CRIMSON	\$2.42	\$2.17	\$2.05	\$3.84

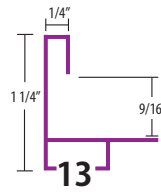

Item #	Color / Finish	List	300+	500+	Chop
N13-14	GERMAN SILVER	\$2.82	\$2.53	\$2.39	\$4.42
N13-179	BLACK METALLINE	\$3.14	\$2.82	\$2.67	\$4.94
N13-21	MATTE BLACK	\$2.82	\$2.53	\$2.39	\$4.42

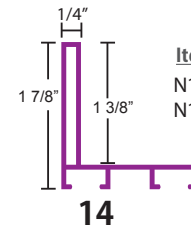

Item #	Color / Finish	List	300+	500+	Chop
N14-14	GERMAN SILVER	\$4.60	\$4.14	\$3.91	\$7.36
N14-21	MATTE BLACK	\$4.60	\$4.14	\$3.91	\$7.36

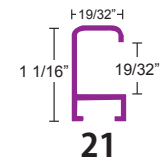

Item #	Color / Finish	List	300+	500+	Chop
N21-224	MATTE WHITE	\$2.89	\$2.60	\$2.46	\$4.46
N21-248	CHINA BLUE	\$2.89	\$2.60	\$2.46	\$4.46
N21-249	OLIVE	\$2.89	\$2.60	\$2.46	\$4.46
N21-256	PEAT	\$2.89	\$2.60	\$2.46	\$4.46
N21-254	MIDNIGHT	\$2.89	\$2.60	\$2.46	\$4.46
N21-250	MERLOT	\$2.89	\$2.60	\$2.46	\$4.46
N21-400	CHROME	\$2.89	\$2.60	\$2.46	\$4.46
N21-50	MATTE BLACK	\$2.89	\$2.60	\$2.46	\$4.46

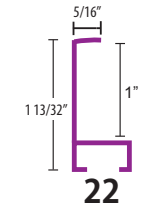

Item #	Color / Finish	List	300+	500+	Chop
N22-01	SILVER	\$2.45	\$2.20	\$2.08	\$3.86
N22-02	FROSTED SILVER	\$2.45	\$2.20	\$2.08	\$3.86
N22-03	GOLD	\$2.45	\$2.20	\$2.08	\$3.86
N22-04	FROSTED GOLD	\$2.45	\$2.20	\$2.08	\$3.86
N22-14	GERMAN SILVER	\$2.86	\$2.57	\$2.43	\$4.51
N22-20	ANODIC BLACK	\$2.86	\$2.57	\$2.43	\$4.51
N22-21	MATTE BLACK	\$2.86	\$2.57	\$2.43	\$4.51

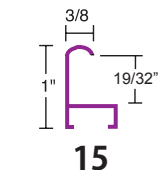

Item #	Color / Finish	List	300+	500+	Chop
N15-171	HUNTER GREEN	\$2.42	\$2.17	\$2.05	\$3.84
N15-170	FROSTED UMBER	\$2.42	\$2.17	\$2.05	\$3.84
N15-18	WALNUT	\$2.42	\$2.17	\$2.05	\$3.84
N15-19	FROSTED WALNUT	\$2.42	\$2.17	\$2.05	\$3.84
N15-205	GRAPE SMASH	\$2.15	\$1.93	\$1.83	\$3.41
N15-20	ANODIC BLACK	\$2.42	\$2.17	\$2.05	\$3.84
N15-204	ELECTRA BLUE	\$2.15	\$1.93	\$1.83	\$3.41
N15-210	CABERNET	\$2.15	\$1.93	\$1.83	\$3.41
N15-213	POPPY	\$2.15	\$1.93	\$1.83	\$3.41
N15-21	MATTE BLACK	\$2.42	\$2.17	\$2.05	\$3.84
N15-217	MOSAIC BLUE	\$2.15	\$1.93	\$1.83	\$3.41
N15-221	SUNBAKED CLAY	\$2.15	\$1.93	\$1.83	\$3.41
N15-222	SAFFRON	\$2.15	\$1.93	\$1.83	\$3.41
N15-23	ANTIQUÉ GOLD	\$2.15	\$1.93	\$1.83	\$3.41
N15-24	COBALT	\$2.42	\$2.17	\$2.05	\$3.84
N15-40	WHITE	\$2.15	\$1.93	\$1.83	\$3.41
N15-41	BLUEBERRY	\$2.15	\$1.93	\$1.83	\$3.41
N15-43	FERN	\$2.15	\$1.93	\$1.83	\$3.41
N15-50	BLACK	\$2.15	\$1.93	\$1.83	\$3.41
N15-52	BRIGHT WHITE	\$2.15	\$1.93	\$1.83	\$3.41
N15-55	RIGHT RED	\$2.15	\$1.93	\$1.83	\$3.41
N15-58	INDIGO	\$2.15	\$1.93	\$1.83	\$3.41
N15-66	LAPIS	\$2.15	\$1.93	\$1.83	\$3.41
N15-68	CHINESE RED	\$2.15	\$1.93	\$1.83	\$3.41

• Prices shown per linear foot

★ Nielsen Aluminum Mouldings are shipped from Omega in San Francisco

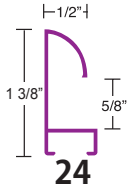

Item #	Color / Finish	List	300+	500+	Chop
N24-414	Brushed Satin German Silver	\$3.01	\$2.70	\$2.55	\$4.61
N24-421	Brushed Satin Black	\$3.01	\$2.70	\$2.55	\$4.61
N24-423	Brushed Satin Antique Gold	\$3.01	\$2.70	\$2.55	\$4.61
N24-469	Brushed Satin Stainless Steel	\$3.01	\$2.70	\$2.55	\$4.61
N24-471	Brushed Satin Slate	\$3.01	\$2.70	\$2.55	\$4.61
N24-473	Brushed Satin Champagne	\$3.01	\$2.70	\$2.55	\$4.61
N24-475	Brushed Satin Chocolate	\$3.01	\$2.70	\$2.55	\$4.61
N24-476	Brushed Satin Sapphire	\$3.01	\$2.70	\$2.55	\$4.61
N24-477	Brushed Satin Frosted Green	\$3.01	\$2.70	\$2.55	\$4.61

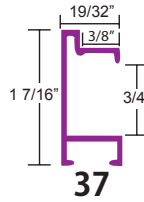

Item #	Color / Finish	List	300+	500+	Chop
N37-179	CARBON BLACK	\$3.48	\$3.14	\$2.96	\$5.43

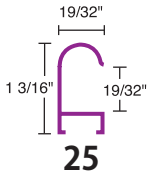

Item #	Color / Finish	List	300+	500+	Chop
N25-01	SILVER	\$2.39	\$2.15	\$2.03	\$3.85
N25-02	FROSTED SILVER	\$2.39	\$2.15	\$2.03	\$3.85
N25-03	GOLD	\$2.39	\$2.15	\$2.03	\$3.85
N25-04	FROSTED GOLD	\$2.39	\$2.15	\$2.03	\$3.85
N25-10	GRAPHITE	\$2.73	\$2.45	\$2.32	\$4.34
N25-14	GERMAN SILVER	\$2.73	\$2.45	\$2.32	\$4.34
N25-170	FROSTED UMBER	\$2.73	\$2.45	\$2.32	\$4.34
N25-19	FROSTED WALNUT	\$2.73	\$2.45	\$2.32	\$4.34
N25-20	ANODIC BLACK	\$2.73	\$2.45	\$2.32	\$4.34
N25-21	MATTE BLACK	\$2.73	\$2.45	\$2.32	\$4.34
N25-24	COBALT	\$2.73	\$2.45	\$2.32	\$4.34
N25-50	BLACK	\$2.39	\$2.15	\$2.03	\$3.85
N25-58	INDIGO	\$2.39	\$2.15	\$2.03	\$3.85

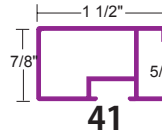

Item #	Color / Finish	List	300+	500+	Chop
N41-E641	GREY ZINC	\$6.49	\$5.84	\$5.52	\$9.97

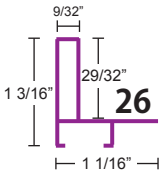

Item #	Color / Finish	List	300+	500+	Chop
N26-E265	WROUGHT COPPER	\$3.61	\$3.25	\$3.07	\$5.75
N26-E264	WROUGHT BRONZE	\$3.61	\$3.25	\$3.07	\$5.75
N26-E543	WROUGHT BRASS	\$3.61	\$3.25	\$3.07	\$5.75
N26-E861	WROUGHT PEWTER	\$3.61	\$3.25	\$3.07	\$5.75
N26-E963	OILED BRONZE	\$3.61	\$3.25	\$3.07	\$5.75

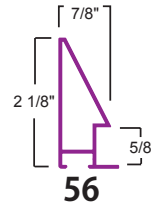

Item #	Color / Finish	List	300+	500+	Chop
N56-14	GERMAN SILVER	\$4.60	\$4.14	\$3.91	\$7.36
N56-21	MATTE BLACK	\$4.60	\$4.14	\$3.91	\$7.36

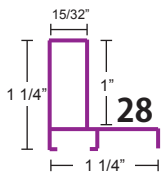

Item #	Color / Finish	List	300+	500+	Chop
N28-02	FROSTED SILVER	\$3.56	\$3.21	\$3.03	\$5.63
N28-247	GUNMETAL	\$4.03	\$3.63	\$3.42	\$6.37
N28-246	OLD GOLD	\$4.03	\$3.63	\$3.42	\$6.37
N28-244	CHOCOLATE	\$4.03	\$3.63	\$3.42	\$6.37
N28-254	MIDNIGHT	\$4.03	\$3.63	\$3.42	\$6.37
N28-255	LAUREL	\$4.03	\$3.63	\$3.42	\$6.37
N28-256	PEAT	\$4.03	\$3.63	\$3.42	\$6.37
N28-50	BLACK	\$3.56	\$3.21	\$3.03	\$5.63

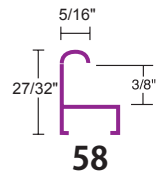

Item #	Color / Finish	List	300+	500+	Chop
N58-01	SILVER	\$1.70	\$1.53	\$1.45	\$2.73
N58-02	FROSTED SILVER	\$1.70	\$1.53	\$1.45	\$2.73
N58-03	GOLD	\$1.70	\$1.53	\$1.45	\$2.73
N58-04	FROSTED GOLD	\$1.70	\$1.53	\$1.45	\$2.73
N58-10	GRAPHITE	\$1.96	\$1.76	\$1.67	\$3.06
N58-12	FROSTED PEWTER	\$1.96	\$1.76	\$1.67	\$3.06
N58-14	GERMAN SILVER	\$1.96	\$1.76	\$1.67	\$3.06
N58-164	DUSK	\$1.96	\$1.76	\$1.67	\$3.06
N58-169	SILVER MOSS	\$1.96	\$1.76	\$1.67	\$3.06
N58-170	FROSTED UMBER	\$1.96	\$1.76	\$1.67	\$3.06
N58-19	FROSTED WALNUT	\$1.96	\$1.76	\$1.67	\$3.06
N58-20	ANODIC BLACK	\$1.96	\$1.76	\$1.67	\$3.06
N58-21	MATTE BLACK	\$1.96	\$1.76	\$1.67	\$3.06
N58-24	COBALT	\$1.96	\$1.76	\$1.67	\$3.06
N58-50	BLACK	\$1.70	\$1.53	\$1.45	\$2.73
N58-52	BRIGHT WHITE	\$1.70	\$1.53	\$1.45	\$2.73

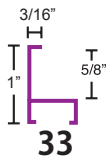

Item #	Color / Finish	List	300+	500+	Chop
N33-13	CONTRAST GREY	\$2.48	\$2.23	\$2.11	\$3.96
N33-50	BLACK	\$2.27	\$2.04	\$1.93	\$3.64

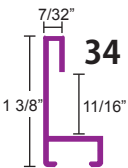

Item #	Color / Finish	List	300+	500+	Chop
N34-14	GERMAN SILVER	\$2.54	\$2.28	\$2.16	\$4.04
N34-179	BLACK METALLINE	\$2.80	\$2.52	\$2.38	\$4.34
N34-21	MATTE BLACK	\$2.54	\$2.28	\$2.16	\$4.04

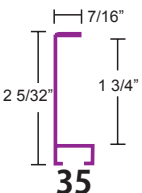

Item #	Color / Finish	List	300+	500+	Chop
N35-01	SILVER	\$4.74	\$4.27	\$4.03	\$7.60
N35-20	ANODIC BLACK	\$5.40	\$4.86	\$4.59	\$8.20

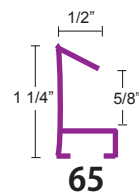

Item #	Color / Finish	List	300+	500+	Chop
N65-244	CHOCOLATE	\$2.89	\$2.60	\$2.46	\$4.46
N65-247	GUNMETAL	\$2.89	\$2.60	\$2.46	\$4.46
N65-245	SPICE	\$2.89	\$2.60	\$2.46	\$4.46
N65-246	OLD GOLD	\$2.89	\$2.60	\$2.46	\$4.46
N65-252	ROBIN'S EGG	\$2.89	\$2.60	\$2.46	\$4.46
N65-251	BARELY GOLD	\$2.89	\$2.60	\$2.46	\$4.46
N65-254	MIDNIGHT	\$2.89	\$2.60	\$2.46	\$4.46
N65-255	LAUREL	\$2.89	\$2.60	\$2.46	\$4.46
N65-429	EBONY	\$2.89	\$2.60	\$2.46	\$4.46

NIELSEN ALUMINUM MOULDINGS

★ Nielsen Aluminum Mouldings are shipped from Omega in San Francisco

• Prices shown per linear foot

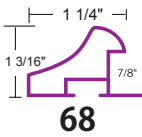

Item #	Color / Finish	List	300+	500+	Chop
N68-14	GERMAN SILVER	\$3.90	\$3.51	\$3.31	\$6.08
N68-19	FROSTED WALNUT	\$3.90	\$3.51	\$3.31	\$6.08
N68-21	MATTE BLACK	\$3.90	\$3.51	\$3.31	\$6.08

68

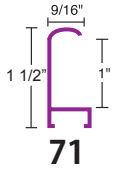

Item #	Color / Finish	List	300+	500+	Chop
N71-01	SILVER	\$2.96	\$2.66	\$2.52	\$4.69
N71-20	ANODIC BLACK	\$3.23	\$2.90	\$2.74	\$5.11
N71-21	MATTE BLACK	\$3.23	\$2.90	\$2.74	\$5.11

71

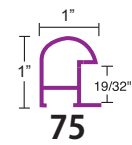

Item #	Color / Finish	List	300+	500+	Chop
N75-01	SILVER	\$3.77	\$3.40	\$3.21	\$5.99
N75-02	FROSTED SILVER	\$3.77	\$3.40	\$3.21	\$5.99
N75-14	GERMAN SILVER	\$4.08	\$3.68	\$3.47	\$6.44
N75-20	ANODIC BLACK	\$4.08	\$3.68	\$3.47	\$6.44
N75-21	MATTE BLACK	\$4.08	\$3.68	\$3.47	\$6.44

75

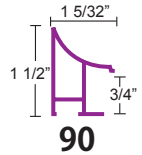

Item #	Color / Finish	List	300+	500+	Chop
N90-14	GERMAN SILVER	\$4.65	\$4.19	\$3.95	\$7.45

90

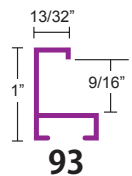

Item #	Color / Finish	List	300+	500+	Chop
N93-01	SILVER	\$2.25	\$2.02	\$1.91	\$3.57
N93-10	GRAPHITE	\$2.54	\$2.28	\$2.16	\$4.04
N93-14	GERMAN SILVER	\$2.54	\$2.28	\$2.16	\$4.04
N93-150	FLORENTINE SILVER	\$2.70	\$2.43	\$2.30	\$4.30
N93-154	FLORENTINE GREY	\$2.70	\$2.43	\$2.30	\$4.30
N93-156	FLORENTINE BLACK	\$2.70	\$2.43	\$2.30	\$4.30
N93-167	FLORENTINE WALNUT	\$2.70	\$2.43	\$2.30	\$4.30
N93-19	FROSTED WALNUT	\$2.54	\$2.28	\$2.16	\$4.04
N93-20	ANODIC BLACK	\$2.54	\$2.28	\$2.16	\$4.04
N93-21	MATTE BLACK	\$2.54	\$2.28	\$2.16	\$4.04
N93-50	BLACK	\$2.25	\$2.02	\$1.91	\$3.57
N93-52	BRIGHT WHITE	\$2.25	\$2.02	\$1.91	\$3.57

93

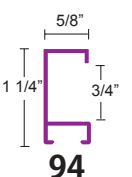

Item #	Color / Finish	List	300+	500+	Chop
N94-01	SILVER	\$2.49	\$2.24	\$2.12	\$3.93
N94-02	FROSTED SILVER	\$2.49	\$2.24	\$2.12	\$3.93
N94-156	FLORENTINE BLACK	\$3.21	\$2.88	\$2.72	\$5.11
N94-179	BLACK METALLINE	\$3.21	\$2.88	\$2.72	\$5.11
N94-20	ANODIC BLACK	\$2.84	\$2.55	\$2.41	\$4.44
N94-21	MATTE BLACK	\$2.84	\$2.55	\$2.41	\$4.44

94

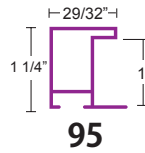

95

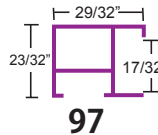

97

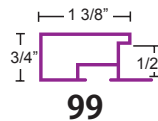

99

Item #	Color / Finish	List	300+	500+	Chop
N95-10	GRAPHITE	\$3.53	\$3.18	\$3.00	\$5.52
N95-14	GERMAN SILVER	\$3.53	\$3.18	\$3.00	\$5.52
N95-21	MATTE BLACK	\$3.53	\$3.18	\$3.00	\$5.52
N95-224	MATTE WHITE	\$3.21	\$2.88	\$2.72	\$5.05
N95-23	ANTIQUÉ GOLD	\$3.21	\$2.88	\$2.72	\$5.05
N95-429	BRITE BLACK BRUSHED	\$3.65	\$3.29	\$3.10	\$5.73
N95-470	BRUSHED SATIN NICKEL	\$4.02	\$3.62	\$3.42	\$6.36
N95-478	BRUSHED SATIN PEWTER	\$4.02	\$3.62	\$3.42	\$6.36

Item #	Color / Finish	List	300+	500+	Chop
N97-14	GERMAN SILVER	\$3.01	\$2.70	\$2.55	\$4.61
N97-155	FLORENTINE AMBER	\$3.45	\$3.11	\$2.93	\$5.41
N97-154	FLORENTINE GREY	\$3.45	\$3.11	\$2.93	\$5.41
N97-156	FLORENTINE BLACK	\$3.45	\$3.11	\$2.93	\$5.41
N97-150	FLORENTINE SILVER	\$3.45	\$3.11	\$2.93	\$5.41
N97-151	FLORENTINE GOLD	\$3.45	\$3.11	\$2.93	\$5.41
N97-152	FLORENTINE BRONZE	\$3.45	\$3.11	\$2.93	\$5.41
N97-167	FLORENTINE WALNUT	\$3.45	\$3.11	\$2.93	\$5.41
N97-168	FLORENTINE COBALT	\$3.45	\$3.11	\$2.93	\$5.41
N97-165	FLORENTINE BRASS	\$3.45	\$3.11	\$2.93	\$5.41
N97-20	ANODIC BLACK	\$3.01	\$2.70	\$2.55	\$4.61
N97-21	MATTE BLACK	\$3.01	\$2.70	\$2.55	\$4.61
N97-400	BRUSHED ALUMINUM SATIN	\$3.45	\$3.11	\$2.93	\$5.41
N97-50	BLACK	\$2.66	\$2.39	\$2.26	\$4.10
N97-550	TUSCAN LINEN SILVER	\$3.45	\$3.11	\$2.93	\$5.41
N97-555	TUSCAN LINEN AMBER	\$3.45	\$3.11	\$2.93	\$5.41
N97-556	TUSCAN LINEN BLACK	\$3.45	\$3.11	\$2.93	\$5.41
N97-700	BEAD FLORENTINE BLACK/SH	\$4.06	\$3.66	\$3.45	\$6.49
N97-702	BEAD FLORENTINE SILVER/SH	\$4.06	\$3.66	\$3.45	\$6.49
N97-800	BEAD FLORENTINE BLACK/GH	\$4.06	\$3.66	\$3.45	\$6.49

Item #	Color / Finish	List	300+	500+	Chop
N99-150	FLORENTINE SILVER	\$3.83	\$3.44	\$3.25	\$6.06
N99-154	FLORENTINE GREY	\$3.83	\$3.44	\$3.25	\$6.06
N99-156	FLORENTINE BLACK	\$3.83	\$3.44	\$3.25	\$6.06
N99-167	FLORENTINE WALNUT	\$3.83	\$3.44	\$3.25	\$6.06
N99-179	BLACK METALLINE	\$3.83	\$3.44	\$3.25	\$6.06
N99-21	MATTE BLACK	\$3.36	\$3.02	\$2.86	\$5.26
N99-227	VIVID RED	\$3.83	\$3.44	\$3.25	\$6.06
N99-237	VIVID PINK	\$3.83	\$3.44	\$3.25	\$6.06
N99-231	VIVID GOLD	\$3.83	\$3.44	\$3.25	\$6.06
N99-238	VIVID AQUA	\$3.83	\$3.44	\$3.25	\$6.06
N99-232	VIVID BLUE	\$3.83	\$3.44	\$3.25	\$6.06
N99-233	VIVID PURPLE	\$3.83	\$3.44	\$3.25	\$6.06
N99-234	VIVID GREEN	\$3.83	\$3.44	\$3.25	\$6.06
N99-235	VIVID ORANGE	\$3.83	\$3.44	\$3.25	\$6.06
N99-230	VIVID SILVER	\$3.83	\$3.44	\$3.25	\$6.06
N99-236	VIVID APPLE GREEN	\$3.83	\$3.44	\$3.25	\$6.06
N99-421	BRUSHED SATIN BLACK	\$3.98	\$3.58	\$3.38	\$6.30
N99-431	BRUSHED ANTIQUÉ GOLD	\$3.83	\$3.44	\$3.25	\$6.06
N99-430	BRUSHED GERMAN SILVER	\$3.83	\$3.44	\$3.25	\$6.06
N99-478	BRUSHED SATIN PEWTER	\$3.98	\$3.58	\$3.38	\$6.30
N99-475	BRUSHED SATIN CHOCOLATE	\$3.98	\$3.58	\$3.38	\$6.30
N99-470	BRUSHED SATIN NICKEL	\$3.98	\$3.58	\$3.38	\$6.30

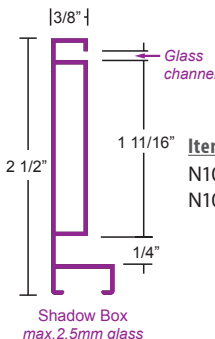

100

Item #	Color / Finish	List	300+	500+	Chop
N100-14	GERMAN BLACK SILVER	\$5.41	\$4.87	\$4.60	\$8.20
N100-21	MATTE BLACK	\$5.41	\$4.87	\$4.60	\$8.20

• Prices shown per linear foot

★ Nielsen Aluminum Mouldings are shipped from Omega in San Francisco

Item #	Color / Finish	List	300+	500+	Chop
N117-01	SILVER	\$2.26	\$2.03	\$1.92	\$3.57
N117-04	FROSTED GOLD	\$2.26	\$2.03	\$1.92	\$3.57
N117-02	FROSTED SILVER	\$2.26	\$2.03	\$1.92	\$3.57
N117-06	FROSTED TAUPE	\$2.54	\$2.28	\$2.16	\$4.04
N117-08	FROSTED BRONZE	\$2.54	\$2.28	\$2.16	\$4.04
N117-10	GRAPHITE	\$2.54	\$2.28	\$2.16	\$4.04
N117-13	CONTRAST GREY	\$2.54	\$2.28	\$2.16	\$4.04
N117-14	GERMAN SILVER	\$2.54	\$2.28	\$2.16	\$4.04
N117-16	CRIMSON	\$2.54	\$2.28	\$2.16	\$4.04
N117-12	FROSTED PEWTER	\$2.54	\$2.28	\$2.16	\$4.04
N117-19	FROSTED WALNUT	\$2.54	\$2.28	\$2.16	\$4.04
N117-164	DUSK	\$2.54	\$2.28	\$2.16	\$4.04
N117-169	SILVER MOSS	\$2.54	\$2.28	\$2.16	\$4.04
N117-170	FROSTED UMBER	\$2.54	\$2.28	\$2.16	\$4.04
N117-171	HUNTER GREEN	\$2.54	\$2.28	\$2.16	\$4.04
N117-21	MATTE BLACK	\$2.54	\$2.28	\$2.16	\$4.04
N117-210	CABERNET	\$2.26	\$2.03	\$1.92	\$3.57
N117-217	MOSAIC BLUE	\$2.26	\$2.03	\$1.92	\$3.57
N117-227	TORNADO RED	\$2.65	\$2.38	\$2.25	\$4.22
N117-23	ANTIQUÉ GOLD	\$2.26	\$2.03	\$1.92	\$3.57
N117-230	REFLEX SILVER	\$2.65	\$2.38	\$2.25	\$4.22
N117-231	GOLD BULLION	\$2.65	\$2.38	\$2.25	\$4.22
N117-20	ANODIC BLACK	\$2.54	\$2.28	\$2.16	\$4.04
N117-232	GALACTIC BLUE	\$2.65	\$2.38	\$2.25	\$4.22
N117-270	BURNT SIENNA	\$2.54	\$2.28	\$2.16	\$4.04
N117-233	PURPLE HAZE	\$2.65	\$2.38	\$2.25	\$4.22
N117-235	TANGRINE TWIST	\$2.65	\$2.38	\$2.25	\$4.22
N117-236	CYBER GREEN	\$2.65	\$2.38	\$2.25	\$4.22
N117-237	RASPBERRY FIZZ	\$2.65	\$2.38	\$2.25	\$4.22
N117-238	TURQUOISE	\$2.65	\$2.38	\$2.25	\$4.22
N117-24	COBALT	\$2.54	\$2.28	\$2.16	\$4.04
N117-240	AMETHYST	\$2.65	\$2.38	\$2.25	\$4.22
N117-314	SATIN LUSTRE SL	\$2.65	\$2.38	\$2.25	\$4.22
N117-470	BRUSHED SATIN NICK	\$3.01	\$2.70	\$2.55	\$4.61
N117-400	BRUSHED ALUMINUM SATIN	\$2.65	\$2.38	\$2.25	\$4.22
N117-478	BRUSHED SATIN PEWTER	\$3.01	\$2.70	\$2.55	\$4.61
N117-50	BLACK	\$2.26	\$2.03	\$1.92	\$3.57
N117-52	BRIGHT WHITE	\$2.26	\$2.03	\$1.92	\$3.57
N117-58	INDIGO	\$2.26	\$2.03	\$1.92	\$3.57
N117-55	RIGHT RED	\$2.26	\$2.03	\$1.92	\$3.57
N117-602	FORGED BARREL BLACK	\$3.46	\$3.12	\$2.94	\$5.48
N117-603	FORGED GUNMETAL GREY	\$3.46	\$3.12	\$2.94	\$5.48
N117-604	FORGED NATURAL STEEL	\$3.46	\$3.12	\$2.94	\$5.48
N117-605	FORGED SILVER SMOKE	\$3.46	\$3.12	\$2.94	\$5.48
N117-68	CHINESE RED	\$2.26	\$2.03	\$1.92	\$3.57

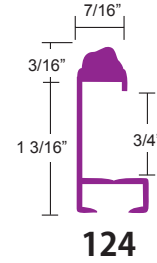
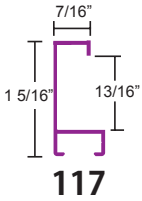

Item #	Color / Finish	List	300+	500+	Chop
N124-G02	SILVER LEAF	\$3.64	\$3.28	\$3.09	\$5.75

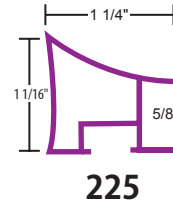

Item #	Color / Finish	List	300+	500+	Chop
N225-154	GRAPHITE	\$3.98	\$3.59	\$3.39	\$6.30
N225-149	BARELY GOLD	\$3.98	\$3.59	\$3.39	\$6.30
N225-168	SAPPHIRE	\$3.98	\$3.59	\$3.39	\$6.30
N225-165	SAGE	\$3.98	\$3.59	\$3.39	\$6.30
N225-319	CAPPUCCINO	\$3.98	\$3.59	\$3.39	\$6.30
N225-452	FROSTED GOLD	\$3.98	\$3.59	\$3.39	\$6.30
N225-469	MODERN PEWTER	\$3.98	\$3.59	\$3.39	\$6.30
N225-421	JET BLACK	\$3.98	\$3.59	\$3.39	\$6.30



Special exceptions on allowances for the following styles:

Style #33:

Only allow 1/16" (rather than 1/8") due to the narrow lip.

Style #75, Style #90 and Style #97:

Due to the design of these profiles, add a total of 1 1/4" to the overall size of your project (1 1/8" + 1/8" allowance).

A		C		E		H	
Abaca.sa Hinging Tape	12	C+H Mat Cutters	66	Earthquake hangers	28, 29, 30, 32	Hand Miter Cutter	44
Acid-Free Backing Paper - <i>Lineco</i>	13	C+H Mat Cutting Blades (#1200 & #1500)	21	Easel Backs	38	Hand-held mat cutter	21
Acid-Free Drymount Tissue	14	C+H Vertical Wall Cutter	66	Easy-Fit Nylon Coated Wire	19	Hangers (hardware)	27-35
Acid-Free Foam Board	1-4	Cable, for Takiya hanging system	27	Econospace	39	Hangers for metal frames	33
Acid-Free Framing Tape	10,11	Canvas hangers	40	Educational Media	51-52	Hangers for Takiya hanging system	27
Acrylate Adhesive	18	Canvas Stretcher Bars	50	Elmers Adhesive Products	17	Hanging Cable for Takiya system	27
Acrylic	5, 7	Canvas Stretching Machines	53	Embossed Easel Backs	38	Hanging Rails, for Takiya system	27
Acrylic Cleaner	8	Canvas Stretching Pliers	41	Encapsulation Film	16	Hanging Support Brackets	28
Acrylic object mounts	41	Carbide Glass Wheel, <i>Foster Keencut</i>	68	Encore Foam Board	1	Hangman Products	40
Acrylic scoring tool	44	Cardboard	48	Euro Hanger (<i>metal frame hanger</i>)	33	Hardpoints	24
Acrylic Scratch Remover	8	Cardboard Corners	48	Excalibur vertical cutters, <i>Foster Keencut</i>	67	Hardware	27-35
Acrylite Acrylic	7	Cassese cartridge wedges	23	Excalibur 5000 Cutting Head	68	Hassle-Free Trim Tool	21
Adhesive bumpers	40	Chartpak Touch-Up Markers	36			Hayaku Hinging Paper	12
Adhesive hanger for foam board	40	Chevrons, hook/velcro self adhesive	49			Heat Activated Foam Board	1, 2, 3, 4
Adhesive Release	18	Chip Breakers	44	F		Heat Mounting Press	54
Adhesive Remover	18	Chopper Blades, Morso	62	Fabric Adhesive	18	Heat Mounting Products	14-16
Adhesive Sprays	17	Choppers	61-62	Filament Tape	11	Heavy duty wall hanger, Hangman	40
Adjustable Offset Picture Hanger	30	Clamp, Joining	26	Fillet Cutter, chopper	62	Hinging Tape	11-12
Adjustable Temperature Tacking Iron	16	Clean Jet 100, Dust Remover	42	Filmoplast	12	Hobby Knives & Blades	22
Air Compressors	61	Cleaning Brush	42	Fitting & Backing Supplies	38-40	Hook & Loop , self adhesive	49
All Purpose Mounting Glue	18	Cleaning Cloths, wipes	42-43	Flangers	31	Hook Chevrons, self adhesive	49
All-In-One Kraft Paper Dispensers	46	Cleaning Pad	42	Flat Back Tape	11	Hooks	27, 28, 29, 30, 35
Aluminum moulding (Nielsen)	105-108	Cleat hanger	36	Flexpoints, Flexible Framing Points	24	Hooks, Takiya	27-28, 29
Amaco Nail Hole & Corner Filler	37	Coated Wire	19, 20	Flobond Dry Mounting Film - <i>Drytac</i>	14	Hot Melt Glue Gun	45
Anchors, screws	32	ColorMount tissue, <i>Bainbridge</i>	14	Flocked Tape	11	Hot Melt Glue Sticks	45
Antiquing Medium, glaze (Z-Crackle)	38	Composite Twin Wheel Cutting Head	68	Foam & Mat Board Storage Cart	45, 70	Hot/Cold Vacuum Press	54
Anti-Static Brushes, cleaning cloths	42	Compressors	61	Foam Board	1-3		
Archival Encapsulation Film	16	Computerized Mat Cutters	63-64	Foam Board cutting, wall cutters	66-67		
Archival Framing Tapes	12	Conservation Framing Tapes	10-11	Foam Overlay for laminating materials	15	I	
Archival Mounting Strips	13	Conservation Tapes, Adhesives	12-13	Foam Padding (by the roll)	49	Inmes Dust Collectors	58
Archival Polyester Mounting Corners	13	Corner Angles (hardware)	35	Folding Bell Hangers	30	Inmes Miter Saws	55-57
Art sleeves	47	Corner Hardware, metal frames	33	Folding Shipping Braces	30	Inmes Underpinners	59-60
Artcare Foam Board	3	Corner Nails	23	Fome-Cor Foam Boards	4	Inmes Universal V-Pins	23
Artglass	7	Corner Pads	48	Foster Keencut accessories, parts	68-69		
Articulated Angles (<i>metal frame hardware</i>)	33	Corner Protectors	48	Foster Keencut blades	21, 68, 69	K	
ArtShield UV Laminating Films	15	Corner Vise	26	Foster Keencut Vertical Cutters	67	Kintronics Static Discharge Brush	42
Artwork cleaning	42	Corner Weld Polyvinyl Glue	18	Frame Backer Paper - <i>Lineco</i>	13	Knives, Morso choppers	62
ATG Tape	9-10	Coroplast	4	Frame Clamp, belt	47	Kool Tack Foam Boards	2
ATG Applicator Guns	9, 10	Corrugated Cardboard	48	Frame Hardware, hangers	29-36	Kraft Paper & Dispensers	46
		Corrugated Plastic (Polypropylene)	4	Frame Joining, vise, clamp	26	KWIK Hangers, for foam board	40
		Cotton Gloves	42	Frame Sealing Tapes - <i>Lineco</i>	13		
B		Courtesy Picture Hooks	35	Frame Touch-Up	36-37	L	
Backing Paper	13, 46	Crepe Masking Tape	11	Frame Wire Clips	30	Laminating Films	15
Backing Paper Dispensers	46	Cutting Head unit, <i>Foster Keencut</i>	68	Framer's Glue	18	Lamination Machine, D&K EXP42	53
Backing Paper Trimmers	21	Cutting Mats, self-healing surface	45	Framers Mounting Corners - <i>Lineco</i>	13	Lamination Machine, D&K EXP42	53
Bainbridge Artcare Foam Board	3			Framer's Point Drivers	25	Lineco Products	12-13
Bainbridge Newsboard	48	D		Framer's Tape II	11	Linen Hinging Tape	12
Bainbridge Products	3	D&K Expression Products	14, 15, 16	Framer's Vise	26	Liquid Leaf	37
Bear Claw Hanger	35	D&K UV Laminating Films	15	Framespace	39	Logan Mat Cutting Blades	21
Beveled Mirror	8	De-roller - D&K	16	Framing media, educational	52	Loop Fabric	49
Bienfang Perforator	16	Dexter Mat Cutter	21	Framing Points	24		
Black Acid Free Foam Board	3	Dexter Style Mat Cutter Blades	21	Fusion 4000 tissue- <i>Bainbridge</i>	14	M	
Black Baron Tacking Iron	16	Diamantor Glass Cutter	44			M&M ATG	9
Black Flocked Tape	11	Digital Printing DVDs	52	Gaffers Tape - Black	10	M&M Heat Activated Foam Board	2
Black Foam Board	2, 3	Dispensers, Kraft	46	Gallery Hanging & Display Products	47	Machinery	53-70
Black Kraft Paper	46	Display Rack	47	Gallery Rod system, parts	36	Magic Tape	10
Black Magic Black Wood Glue	18	Document Cleaning Pad	42	GatorFoam	4	Manual mat cutter	21
Black Masking Tape	11	Document Repair Tape - <i>Lineco</i>	12	Gilman Foam Board	3	Markers, touch-up	36
Blades - Mat Cutting & General Use	21-22	Double Miter Saws	55-56	Glass	5-8	Masking Tape	11
Blades for Hobby Knives	22	Double Sided Tape	10	Glass Breaking Pliers	44	Master Clamp	26
Blades for Utility Knives	22	Double-Head Bear Claw Hanger	35	Glass Cleaner	8	MasterCore Foam Board	4
Blades, Mat Cutting	21, 69	Double-Sided Tape for Fabric	11	Glass Cutter, hand tool	44	Mat Blades	21
Blades, XACTO	22	D-rings	29, 31	Glass cutting cartridge, <i>Foster Keencut</i>	68	Mat Blades, <i>Foster Keencut</i>	69
Board Cutting Blades, <i>Foster Keencut</i>	68	D-rings, angled	29	Glass Cutting, vertical wall cutters	66-67	Mat Boards	71-104
Bone Folder	41	D-rings, Takiya	29	Glass scoring wheel, <i>Foster Keencut</i>	68	Mat Cutters	63-66, 69
Books, educational/instructional	51	Dry Mounting Products	14-16	Gloves, artwork handling	42	Maxim Blue Wood Glue	18
Box Sealing Tape	11	Dry Mounting Release Board	14, 15	Gloves, for handling glass	44	Mending Plates (hardware)	35
Braces for crating, transport	30	Dry Mounting Release Film	15	Glue - Fabric Mounting	18	Mending Tissue	12
Brackets for hanging support	28	Dry Mounting Release Paper	14, 15	Glue - <i>joining wood moulding</i>	18	Metal Frame joining hardware	33
Brad Nails for Pneumatic Drivers	26	Drymount hangers	40	Glue - <i>joining polystyrene moulding</i>	18	Metal Frame security hanging hardware	32
Braided Picture Wire	19-20	Drymount Tissue	14	Glue for mounting in vacuum press	18	Metal Frame moulding (Nielsen)	105-108
Brass Gallery Rod System, parts	36	Drymounting Press	54	Glue Gun	45	Metal Rulers, straight edge	41, 70
Brass Picture Hooks	35	Drytac Products	14, 15	Glue Sticks	45	Methyl Cellulose Adhesive (<i>Lineco</i>)	13
Brush 'N Leaf	37	Drytac Hot/Cold Vacuum Press	54	Glues & Adhesives	17-18	Microfiber Cloths	42
Bubble Bags	48	Drytac Laminating Films	15	Gold, gilding touch-up materials	37	Mighty Mounts	41
Bubble Corner Pads	48	Dust Collectors	58			Mirror Tape - Black	10
Bubble with Kraft Backer	49	Dust Cover Adhesive	18			Mirrors	8
Bubble Wrap (by the roll)	49	Dust remover	42			Miter Choppers	61-62
Buffermount tissue - <i>D&K</i>	14	Dusting Brush	42			Miter Cutter hand tool	44
Bulk Foam Board	2	DVDs & digital, educational media	52				
Bumpers , adhesive bump-ons	40						
Burnishing Bone	41						

M • continued

Miter Disc Sander 55
Miter Fusion - acrylate adhesive 18
Miter Magic - polyvinyl wood glue 18
Miter Saws 55-57
Miter Vise 26
Morso Choppers & Blades 61-62
Moulding Hooks 35
Moulding joining, vise, clamp 26
Mountable Kraft Paper Dispensers 46
Mountable Tape Dispenser 11
Mounting Spray Adhesives 17
Mounting & Hanging Supplies 40-41
Mounting Corners - Lineco 13
Mounting Glue - Vacuum Press 18
Mounting Strips - Lineco 13
Mounting Tissues & Release Boards 14-16
M-Tork cleaning towels, dispenser 43
Mulberry Hinging Tape (Lineco) 12
Multiple Function Wall Hook 28
MuSE by Takiya 27-30
Museum Acrylic
Museum Glass 6, 7

N

Nail Hole & Corner Filler 37
Neschen Products 12
Newsboard 48
Nielsen aluminum moulding 105-108
No-Lint wipes 43
Non-Glare Glass 5
Novus Acrylic Products 8
Nylon Coated Wire 19, 20

O

Object mounts 41
Offset Clips 33
Offset Wall Hanger/Hook 28
Omega Cleat Hanging System 36
Omega Drymounting Release Paper 15
Omega Foam Board 2
Omega Framing Points 24
Omega Dry Mount Tissue 14
Omega Silicone Release Film 15
Omer Flexible Framing Points 24
Omer Hard Framing Points 24
Optium Museum Acrylic, Tru Vue 5

P

Packaging Tape 11
Packing Materials & Supplies 48
Paper Roll Dispensers 46
Pen Knife - XACTO 22
pH Neutral Adhesive - Lineco 13
Phenolic Chip Breaker 44
Phenolic Scrap Support 44
Photo Corners - Lineco 13
Photo Tape - Double Sided 10
Picture Framing educational media 51-52
Picture Hanging Hardware & Fasteners 27
Picture Hooks 35
Picture Hooks, bulk 35
Picture Wire 19-20
Pistorius Saws, chip breakers 44
Pistorius Saws, scrap supports 44
Pistorius Underpinners - Nails 23
Plastic Bag Roll Dispensers 46
Plastic Bags (by the roll) 48
Plastic Scratch Remover 8
Plastic Sleeves 47
Plastic spacers 39
Plastic Stretch Wrap (roll) 49
Plastic Stretch Wrap (wand) 49
Platen Cleaner 16
Pliers for glass breaking (glass snips) 44
PMA - Positionable Mounting Adhesive 16
Pneumatic Brad Nailer 25
Pneumatic Framing Points 24
Pneumatic Miter Choppers 61-62

P • continued

Pneumatic Point Drivers 25
Pneumatic Staple Guns 25-26
Pneumatic Underpinners 59-60
Point Drivers 25
Points 24
Polyester Tape - Clear 10
Polyvinyl Glue 18
Positionable Mounting Adhesive 16
Premium Canvas Pliers, Fredrix 41
Premium Strap Hangers 29
Print Display Rack 47
Print Holders 47
Print sleeves 47
Professional Trimming Tool (*for backing*) 21
Putnam/AMP Underpinners - Nails 23
Putty, nail hole & corner filler 37
PVC Tape 11

R

Rabbit Support for Morso choppers 62
Rabbit Tape - Lineco 13
Rabbetspace 39
Ragmount Dry Mounting Tissue - D&K 14
Rails, for Takiya hanging system 27
Razor Blades 21
Reflection Control Acrylic 5, 7
Reflection Control Glass 6, 7
Regular Glass 5
Release Board 14, 15
Release Paper 14, 15
Removable Tape 10
Repositionable 75 Spray Adhesive - 3M 17
Retractable Utility Knife 22
Rice Starch Adhesive 13
Rigid Framing Points 24
Rotating Miter Saws 55
Router Bits for C+H Thumbnailer 24, 53
Rub 'N Buff 37
Rulers 41

S

Safety Glasses 56
Sanding Discs, 3M 55
Saw Cleaner 56
Sawdust Collectors 58
Sawtooth hangers 34
Scissors, pro grade 41
Scotch Positionable Mounting Adhesive 16
Scotch Tapes, 3M 10
Scrap Supports 44
Screw Eyes 33
Screws 34
Sealant, Silicone 17
Security Hardware by Takiya 28
Security Hardware, hanging 28, 32
Security Hooks, floret style 29
Self-healing Cutting Mats 45
Senco Products 25, 26
Senco Staples, Brads 25, 26
Shadow-box framing, object mounts 41
Shipping Braces 30
Shrink Wrap 49
Shrink Wrap Machine, Traco 40" 53
Sightline Strips, Foster Keencut 68
Silicone Release Board 15
Silicone Release Board 15
Single Step Foam Board 1
Slotted Security Plate (security hardware) 32
Snap Blade Utility Knife 22
Snap Blades 22
Snap Hangers (metal frame hardware) 33
SoftStrand Stainless Steel Wire 19
Spacemaker 39
Spacers 39
Specialty Glass 6-7
Specialty Hanging Systems 27-30
Specialty Tools & Cleaning Items 41-45
Specialty Wall Hooks/Hangers 27-28, 29
Speck Grabber 42

S • continued

SpeedMount foam board 3
Spray Adhesives 17
Sprayway Adhesive Spray 17
Sprayway Glass & Acrylic Cleaners 8
Sprayway Lint & Dust Remover 42
Sprayway Saw Cleaner 56
Spring Clips (metal frame hardware) 33
Stainless Steel Wire 19
Standoff Hardware 47
Staples 26
Static Discharge Brush 42
Steel Hangers 31
Stick-on hangers for foam board 40
Stitchery Tape 11
Storage Unit for mat boards 70
Straight Edges 41, 70
Straight Edges, laser trued 70
Strap Hangers 29, 31
Strap Hangers, Takiya 29
Stretch Wrap (roll) 49
Stretch Wrap (wand) 49
Stretcher Bars 50
Substrate cutters, vertical 66-67
Super Shears 41
Super SoftStrand 19
Support Brackets, hang weight support 28
Surflon Crimping Pliers 20
Surflon Crimping Sleeves 20
Surflon Wire System 20
Swiss Clips 40

T

Table Top Kraft Dispensers 46
Tacking Irons 16
Takiya products 27-30
Tape Dispensers 11
Tape Measure 41
Tapes, Adhesives, & Mounting Supplies 9-11
Tapped Angles (*metal frame hardware*) 33
T-Clip Flush Hangers 30
Tensador Canvas Stretching Machines 53
Thumbnail Joining Inserts 24
Thumbnail Master Router, C+H 53
Tiger Cloth, anti-static cloth 42
Tissue Perforator 16
Touch-Up & Fillers 36-38
Traco Shrink Wrap Machine, 40" 53
Treasure Gold 37
Trimming Tool for Backing Paper 21
TriMount Dry Mounting Tissue - Drytac 14
Tru Vue 5-6
Tru Vue Premium Glass Cleaner 8
T-screw (security hardware) 32
Turnbuttons 35
Twin-Wheel Cutting Head, Foster Keencut 68
Tyvek Backing Paper - Lineco 13

U

Ultimat Series Mat Cutters, Foster Keencut 69
Ultimo II Storage Cart for Mat Board 45
Ultra Vue 6
Underpinner V-Nails 23
Underpinners 59-60
Un-du Adhesive Remover 18
UnStik Adhesive Release 18
Utility Knife Blades 22
Utility Knives 22
UV Laminating Films 15
UV Protection Glass 6, 7

V

VacuGlue 3000 18
Vacuum Press 54
Valiani Mat Cutters 63-65
Vanguard Smart Glass 7
Velcro 49
Velour Easel Backs 38
Vertical Kraft Paper Dispensers 46
Vise 26
VistaMount Mounting Tissue - Drytac 14
Vivian Kistler books & DVDs 51, 52
V-Nails 23
Volara Foam Rabbet Tape - Lineco 13

W

Wall bracket (*security hardware*) 32
Wall bracket, cleat hanger 36
Wall Cutters, substrate/board/glass 66-67
Wall Hooks 27, 28, 29, 30, 35
Wall Hooks, Takiya 28, 29
Wall mounted Support Brackets 28
Water White Glass 6, 7
Weight Support, wall hanging 28
Wheat Starch Adhesive (Lineco) 13
White Glue 18
Wire Brads 34
Wire Caddy 19
Wire Clips 30
Wire Products 19-20
Wood Frame Security Hardware 28, 32
Wood Glue 18
Wypall cleaning wipes 43

X-Z

XACTO Products 22
Z-Cleat, hanging bars 36
Z-Crackle 38
Z-Gel 38
Zig-Zag plastic foamboard hanger 40

The new Omegamoulding.com

Our new and improved website features enhanced product views and search functions, easy online ordering, and many more useful tools to elevate your online experience. With the enhancements to product views and search functionality, everything from mouldings to framing supplies is easy to access due to expanded search filters and refined direct searching. You can now view products in high resolution with additional detail views, similar product offerings and downloadable images.

Did You Know?

On Omega's new website you can:

- Create a Wishlist to save favorite mouldings and share them via email with your customers.
- Update your sample wall using our Discontinued Corners Tool
- Send a service request to your sales rep or customer service
- View your Order History
- See Your Account Balance & Pay Your Bill
- Manage Your Profile: Change email address, phone number and update your ship-to addresses
- Search for a Moulding using the most robust search tool in the industry
- Find mats, glass and supplies
- Check inventory
- View our Digital Catalogs
- Check out our New Collections
- See all our current specials
- Watch instructional videos
- Use our Frame Calculator to determine how much moulding you need for your project
- Place your order anytime 24/7!





OMEGA
MOULDING COMPANY

CONTACT • FAQ • QUICK ORDER • SIGN IN

PRODUCTS SPECIALS NEW COLLECTIONS RESOURCES ACCOUNT

search



mouseover to zoom in • click to download

83367

Artisan

3" Black W/Red Scoop W/Gold Lip

Width	Height	Rabbit
3"	2 1/16"	3/8"

Style: **Classic/Traditional, Colonial, Certificate/Diploma**

Color: **Black/Gold**

Finish: **Gold/silver Accent**

Additional Colors Available:
Water Gild Gold, Water Gild Silver

Additional Sizes Available:
1 1/2"

ⓘ Please [Sign In](#) to check availability and pricing



OMEGA⁺

QUALITY FRAMING PRODUCTS

1 Sawgrass Drive • Bellport, NY 11713-1547

SERVING THE FRAMING INDUSTRY FOR 50 YEARS



Telephone: 1-800-BUY-OMEGA (1-800-289-6634) • Fax: 1-800-329-6634 • Web: www.omegamoulding.com