

# ΩMEGA<sup>+</sup>

MOULDING CATALOG

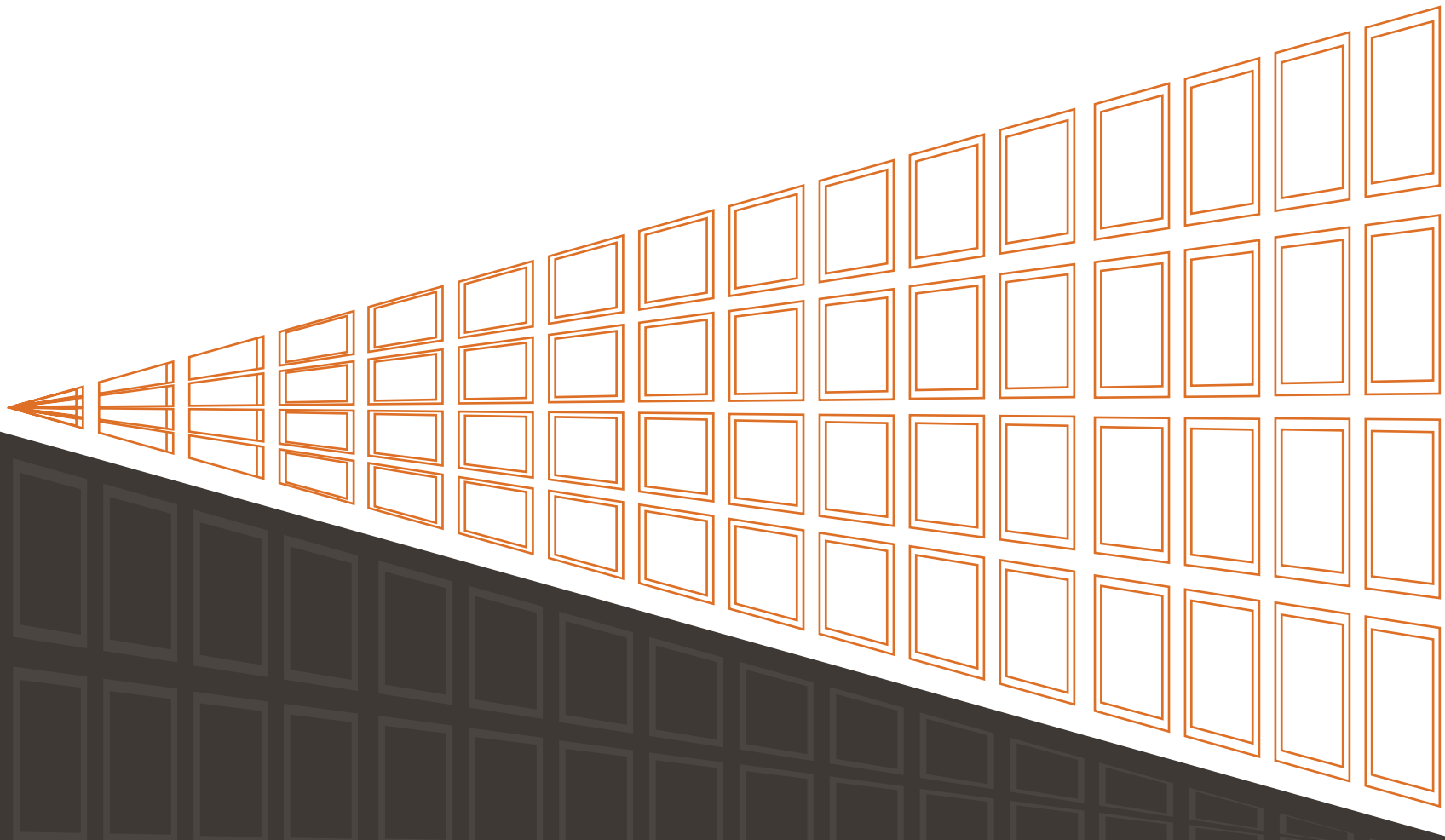

VALUE AND VISION

# CONTENTS

---

	2	MODERN TRANSITIONAL
CLASSICAL	30	
	88	WOOD TONES
RUSTICS	118	
	126	COLORFUL
BLACK & WHITE	132	
	142	THE O <sub>2</sub> COLLECTION
FLOATERS, LINERS & STRETCHERS	152	
	157	FLOATMATE
GALLERY FRAMES	165	
	183	RPS RECYCLED POLYSTYRENE MOULDINGS

*Genuine olive wood veneer mouldings*

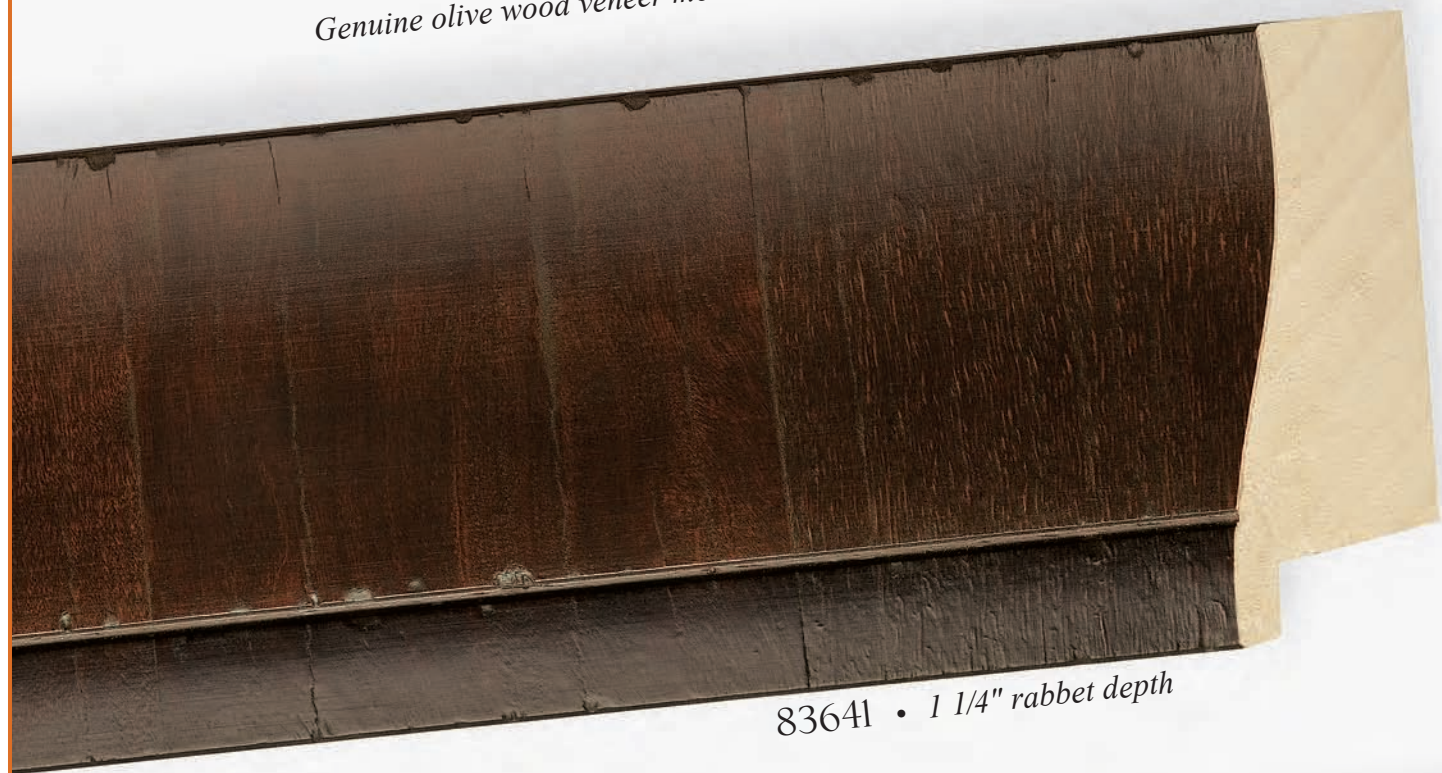

83641 • 1 1/4" rabbet depth



83642



83643

*Genuine olive wood veneer mouldings*

83633

83637

83634

83638

83636

83640

83635

83639



83784

*Genuine Daniela wood veneer*



83783

83787



83786



83785



83778



83779



83782



83781

83780



*Aluminum veneer mouldings*



80813



80816



80815



80818



80814



80817



83695



83696



83694



83697



83698



83699





83650

83653



83652



83655



83654



83651





*1 5/8" rabbet depth • 83645*

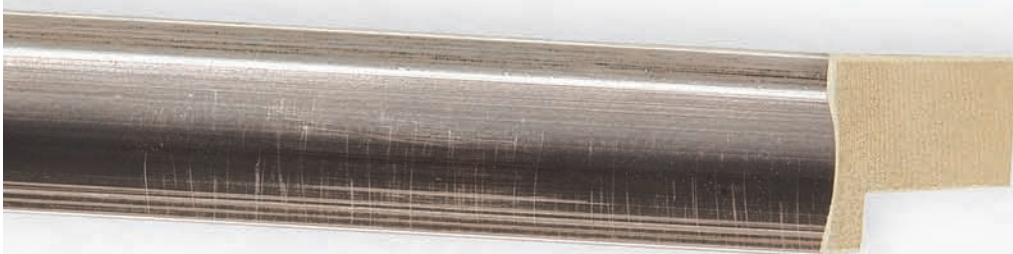

*1 3/8" rabbet depth • 83648*



*1 5/8" rabbet depth • 83646*



*1 3/8" rabbet depth • 83649*



*1 5/8" rabbet depth*

83644

83647



*1 3/8" rabbet depth*



83359

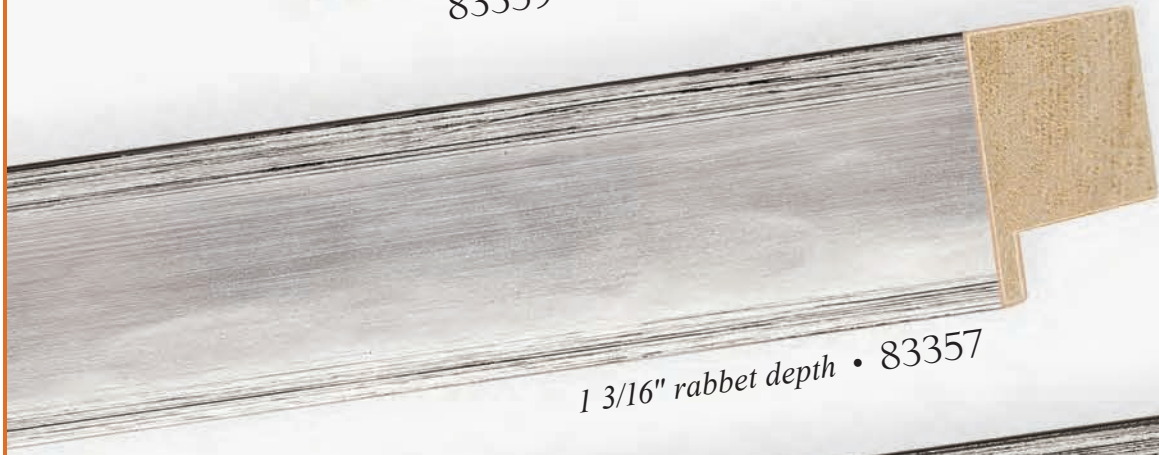

*1 3/16" rabbet depth • 83357*



83358



83360



83356

*1 1/2" rabbet depth*



83361

*1 1/2" rabbet depth*



80801



80802



80803

*1" rabbet depth*

80804

*1" rabbet depth*

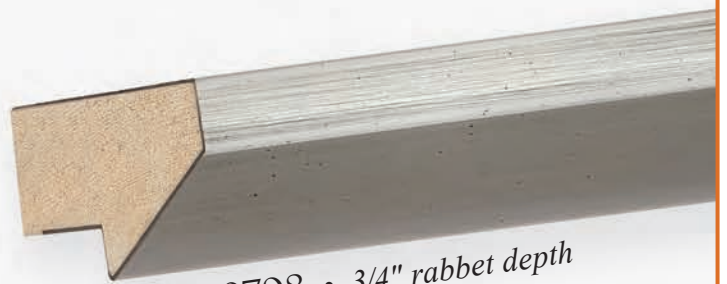

80798 • *3/4" rabbet depth*



80800 • *3/4" rabbet depth*



83758

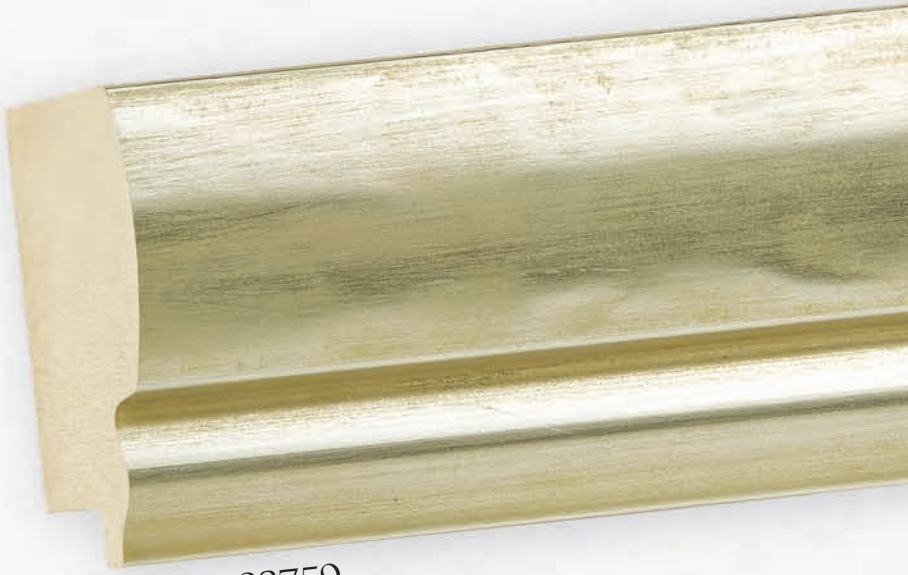

83759

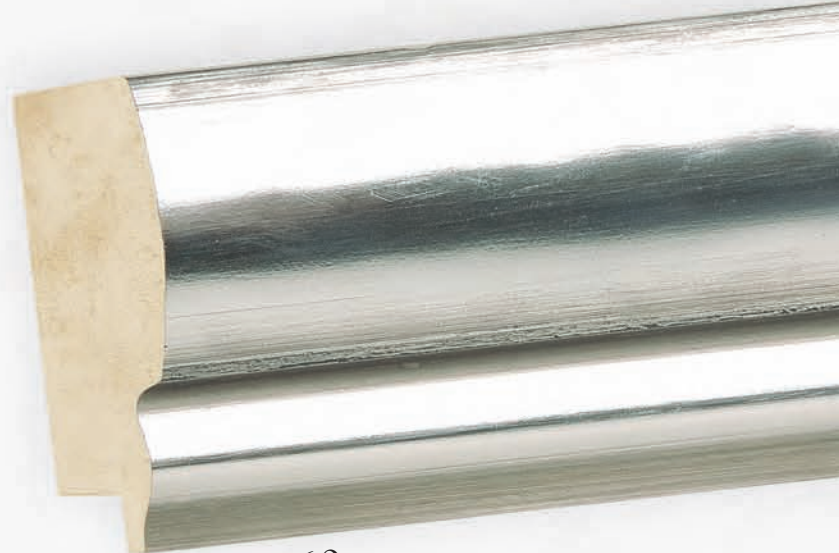

83760



83761



83762

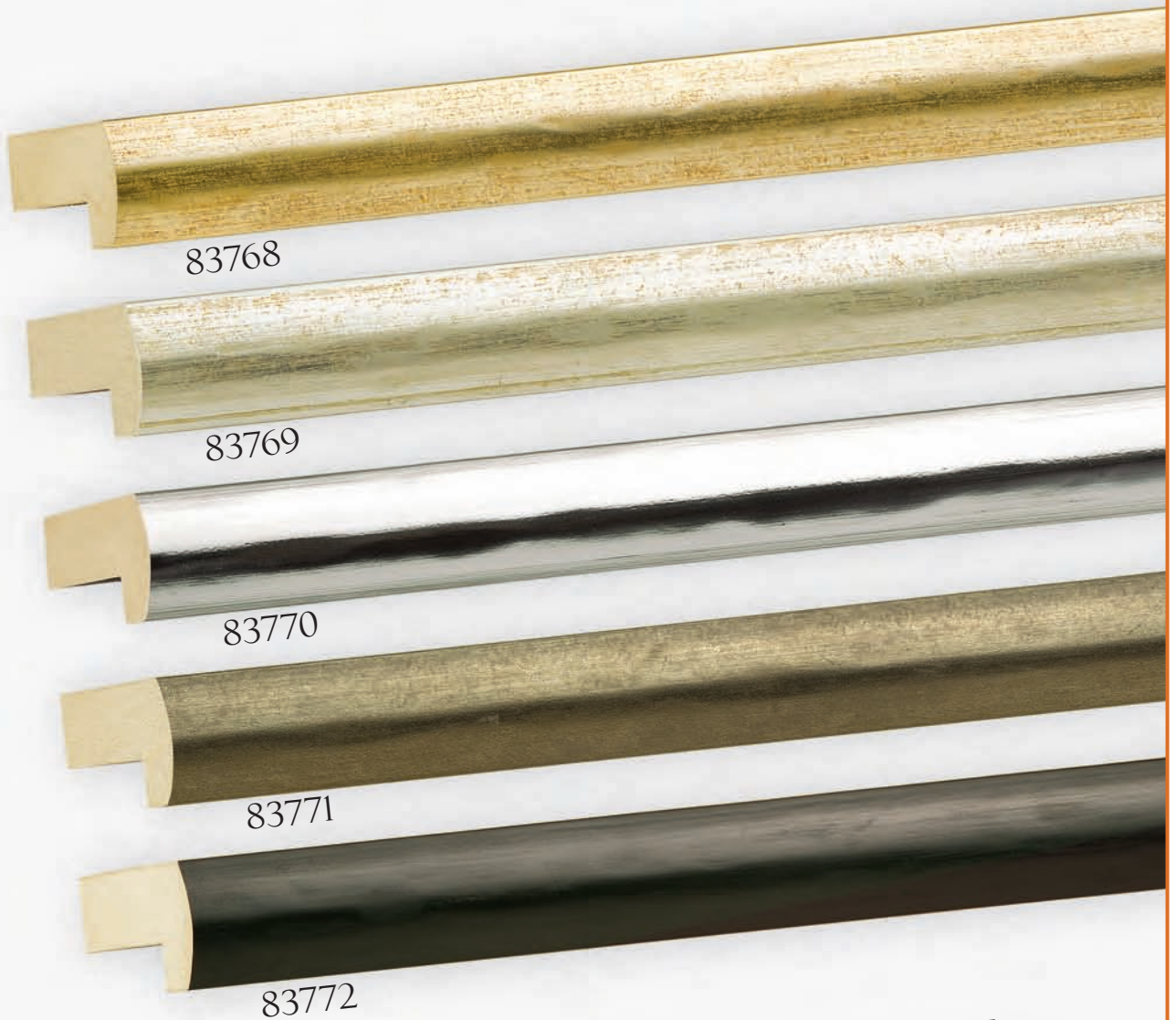

83768

83769

83770

83771

83772

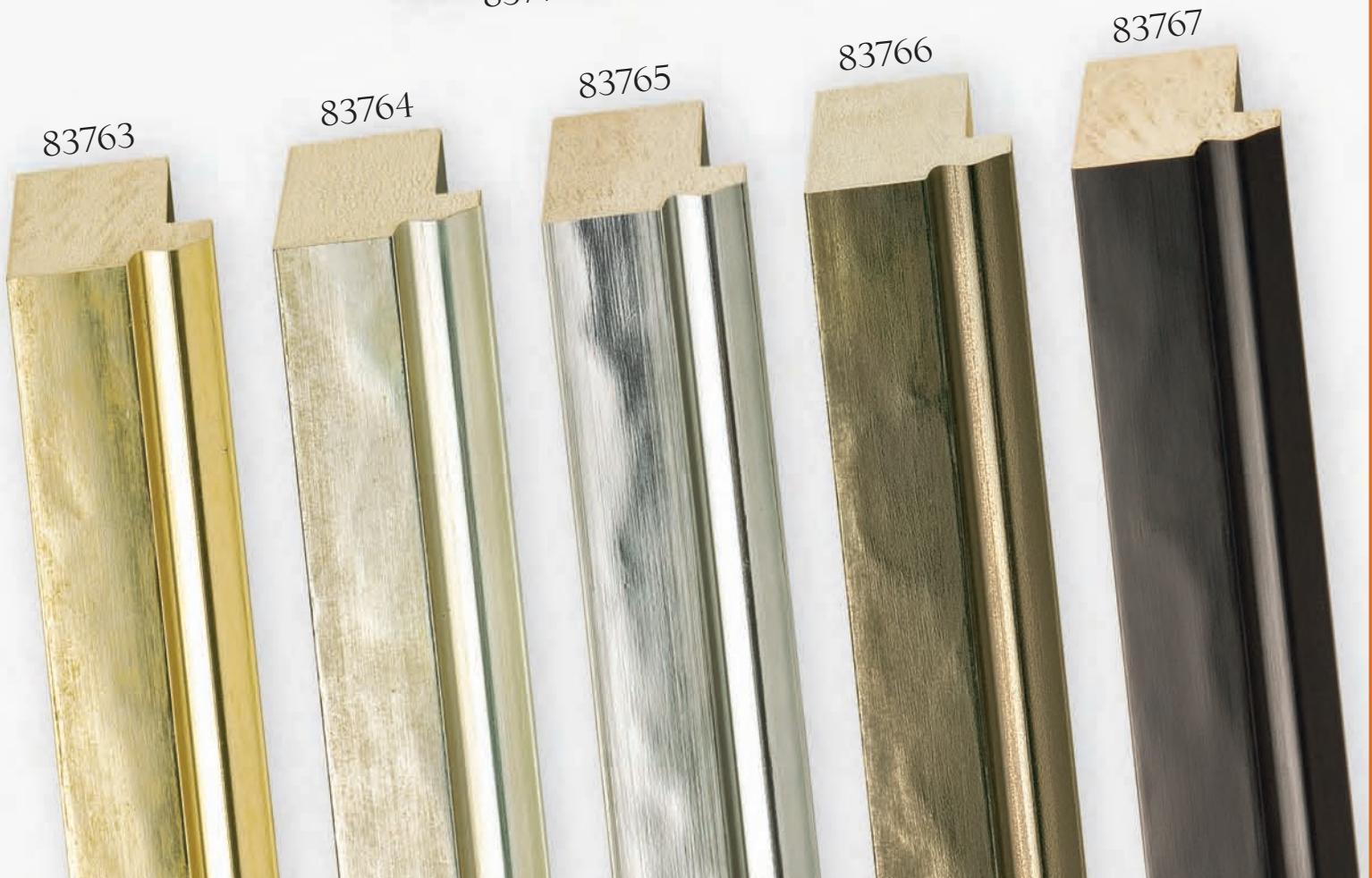

83763

83764

83765

83766

83767



*1 15/16" rabbet depth • 83878*

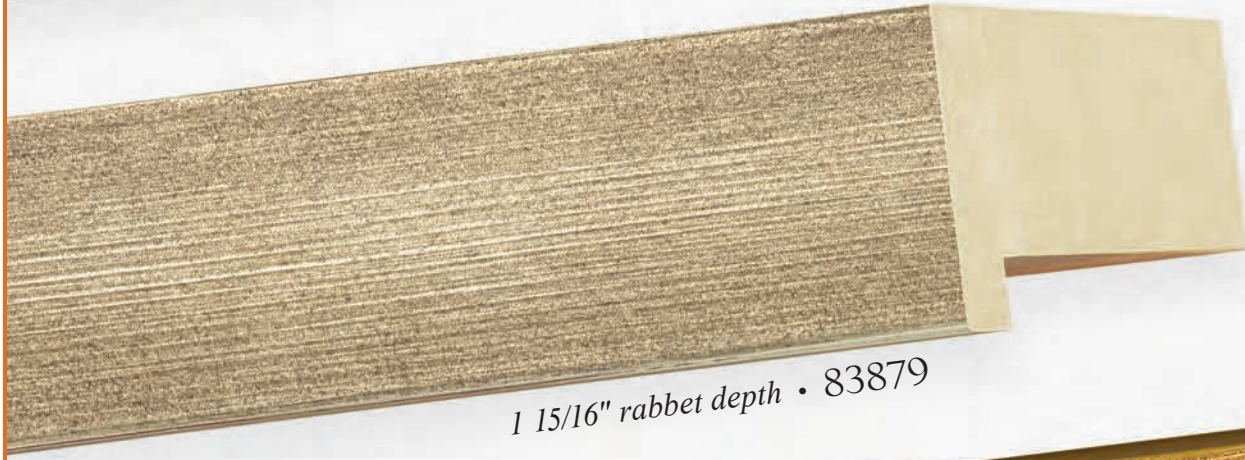

*1 15/16" rabbet depth • 83879*



83883

*1 15/16" rabbet depth*



83884 • *3/4" rabbet depth*



83885 • *3/4" rabbet depth*



83889 • *3/4" rabbet depth*



83881 • 1 15/16" rabbet depth



1 15/16" rabbet depth • 83882



1 15/16" rabbet depth • 83880



3/4" rabbet depth

83888



83886



83887

3/4" rabbet depth





83710



83711

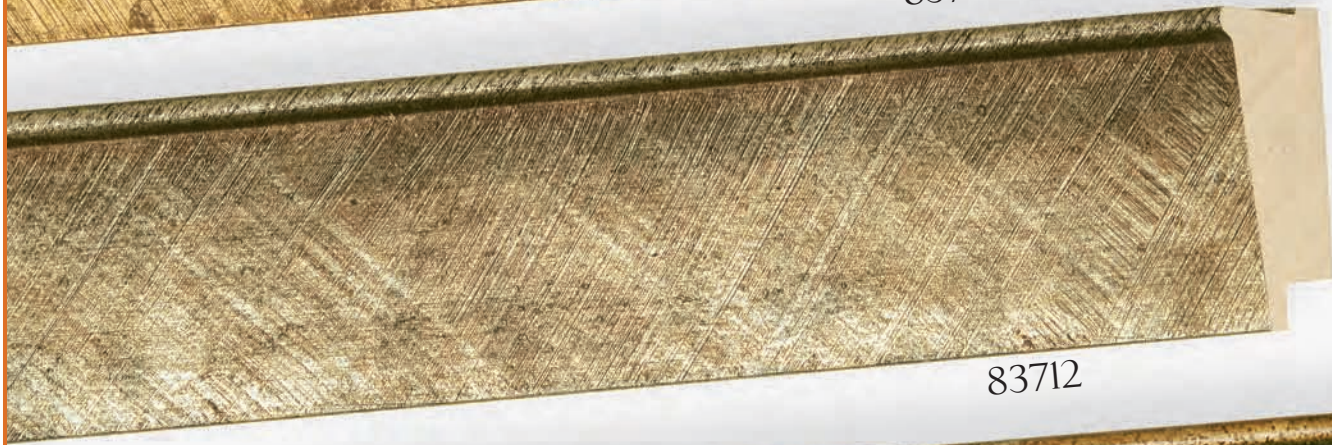

83712

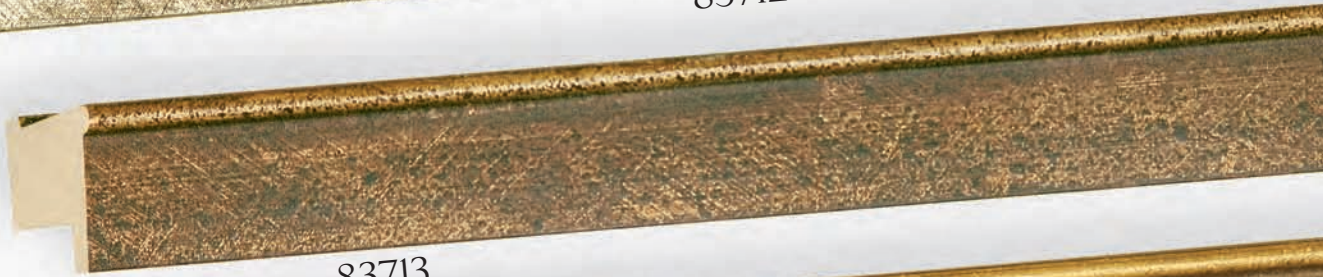

83713



83714

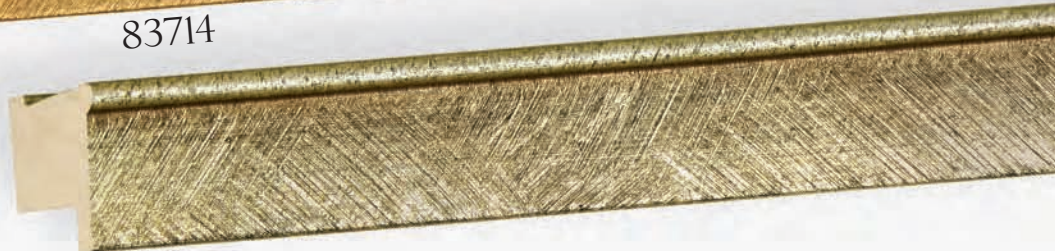

83715

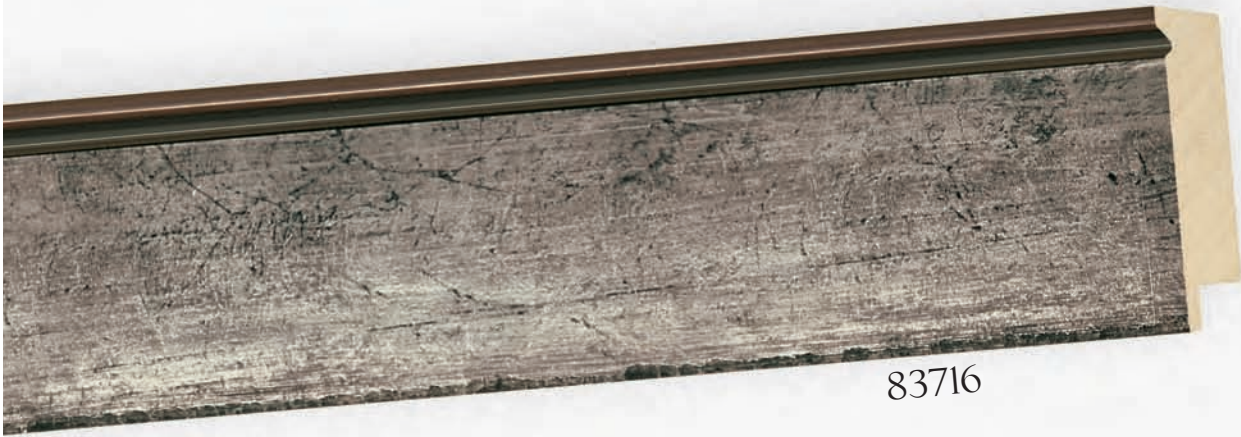

83716



83717



83718



83719



83702



83703



83704



83705

*High-Gloss Black*



83706

*High-Gloss White*



83707



83708



83709

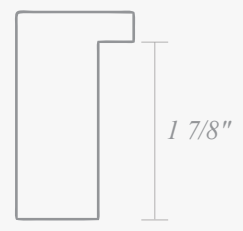



*1" rabbet depth • 83794*



*1" rabbet depth • 83795*

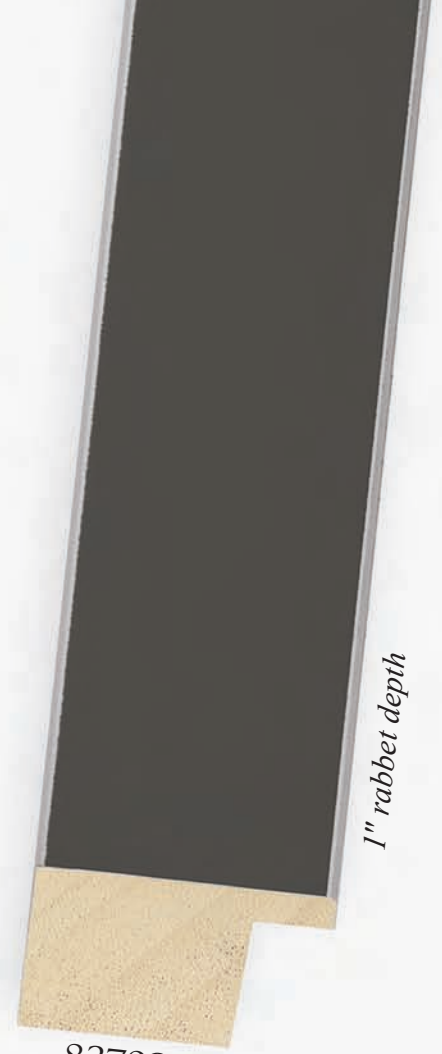

*1" rabbet depth*

83793

83796



*5/8" rabbet depth*



*83797 • 5/8" rabbet depth*



*83798 • 5/8" rabbet depth*



80482



80484



80483



80486



80488



80487



80498



80496



80407

*1 1/2" rabbet depth*



80409

*1 1/2" rabbet depth*



80408

*1 1/2" rabbet depth*



80401



80413 • *1" floater depth*



*1 1/2" floater depth • 83302*



*1 1/2" floater depth • 83303*



*1 3/4" rabet depth • 83298*



*1 3/4" rabet depth • 83299*



83296



*1" rabet depth*

83297

83300



*1/2" rabet depth*

83301



*1/2" rabet depth*



83391



83392



83389



83390

83387



*13/16" rabbet depth*

83388



*13/16" rabbet depth*





80881



80884



80878

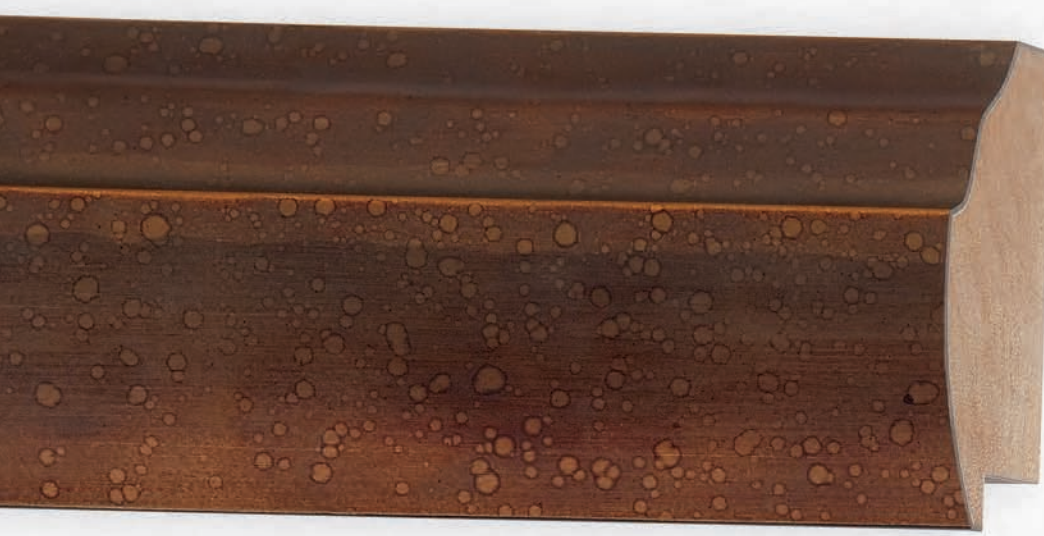

80879



80880

80886

80883



80882



80885



81000



81003



81006

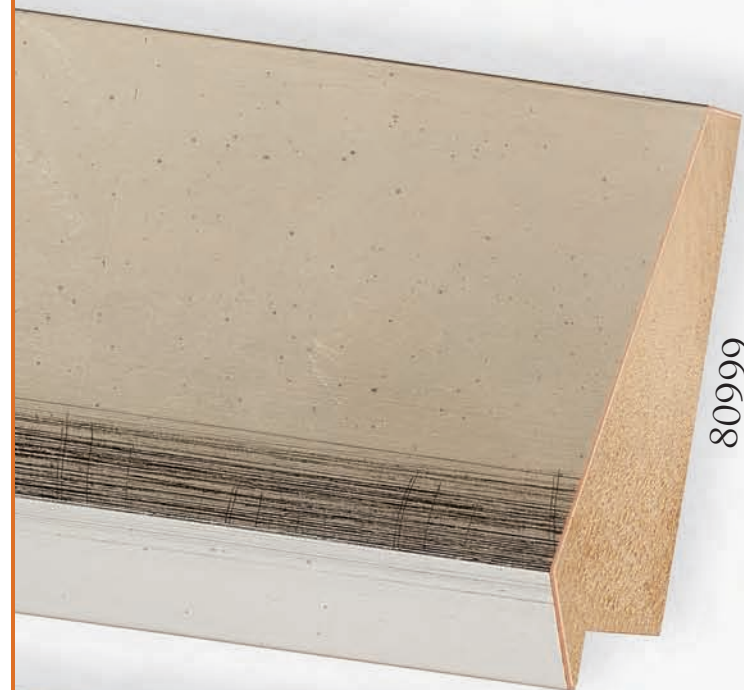

80999



80998



81002



81001



81005



81004



83626

*bronze with gold lip*



83627

*pewter with silver lip*



83581 • bronze



83580 • black



83625

*black with pewter lip*

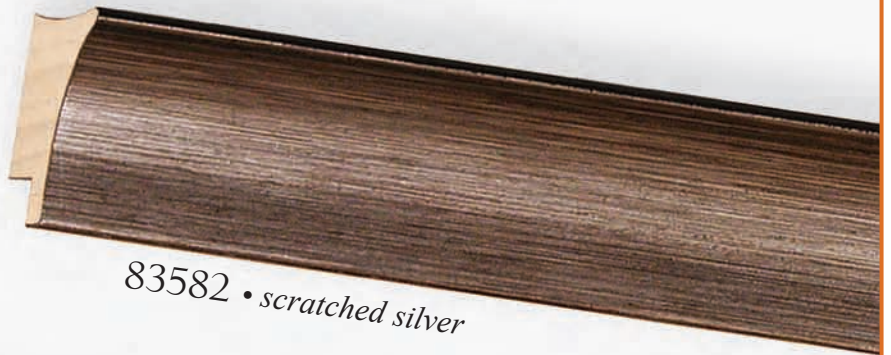

83582 • scratched silver

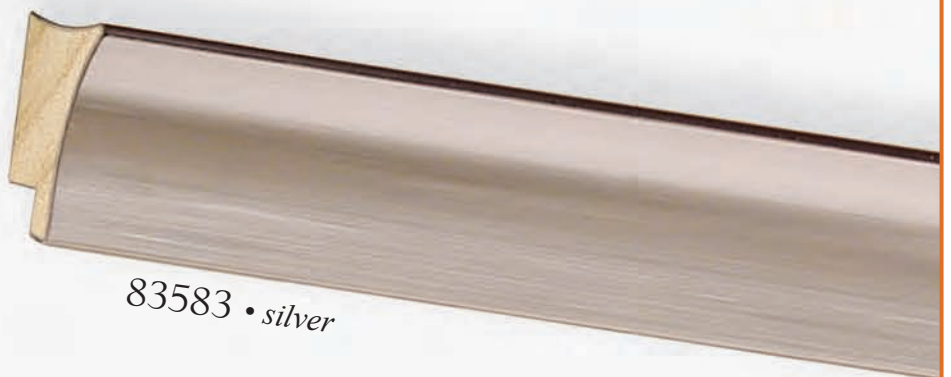

83583 • silver



80970



80971



80972



80977



80983



80978

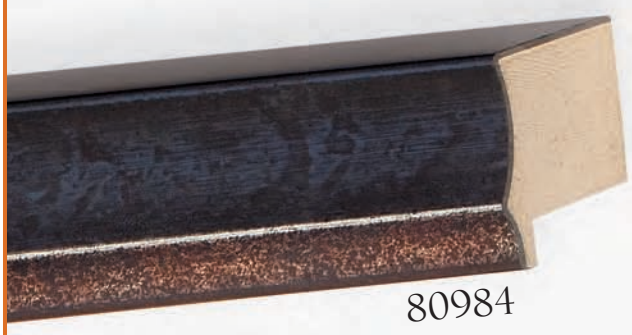

80984



80974



80975



80670



80666



80671



80667



80672



80668



83366



83367



83368



83370



83371



83369



83799



83800



83801



81012



81013





80992



80993



80996



80997



80994



80995



79251



79252



79253



79525



79523



79524



79023



79024



79021



80601

80602



80604

80709

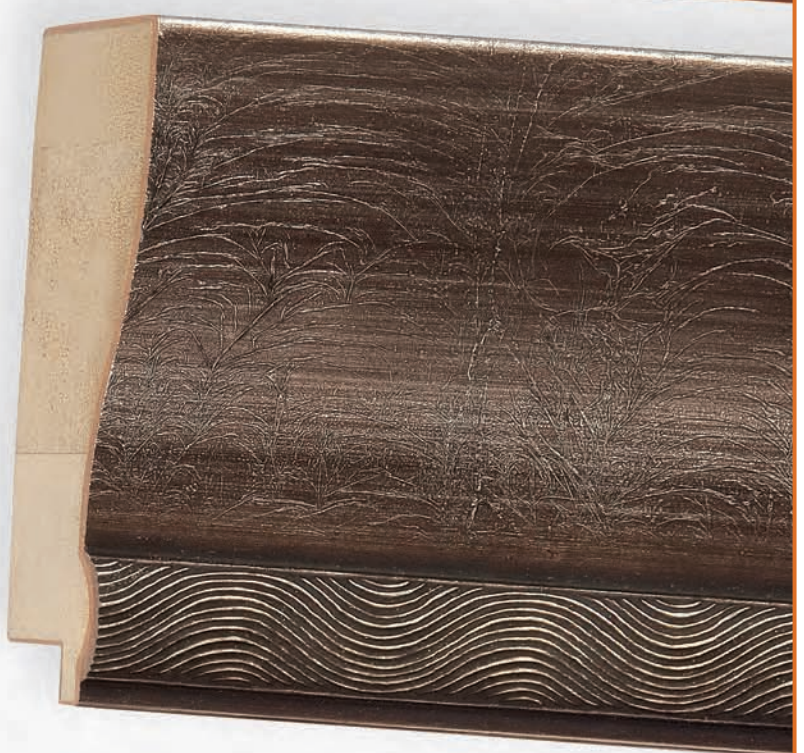

80603



80605

80710





fillet • 80434



80431



80433



80430



80432

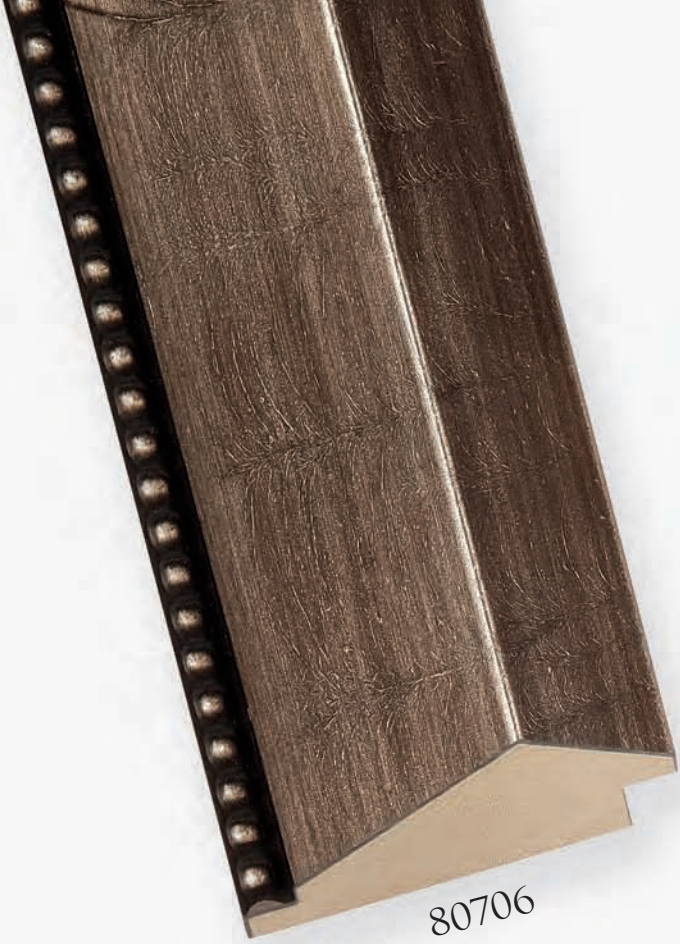

80706



80704



80707



80705



80708 • fillet



80420



80419



80418



*1 1/2" rabbet depth • 80628*



*80629 • 1 1/2" rabbet depth*



*1 1/2" rabbet depth • 80630*





80221



80222

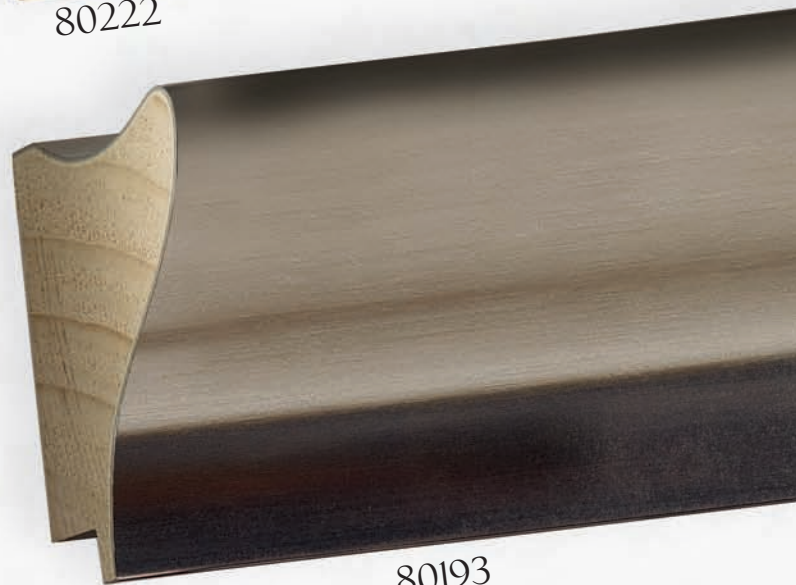

80193



80688



80678



80194



80227



80161

80169



80177



80228

80184



80183



80182



80178



80179





79649



79832



79648



79834



79912



79833



79831



80869

80870

80871

80865

80861

80867

80863

80866

80868

80862

80864



80490



80491



81010



81009



81007



81008



83381



83382



83383

83449



83384



83385



83386

83451



83450



83452



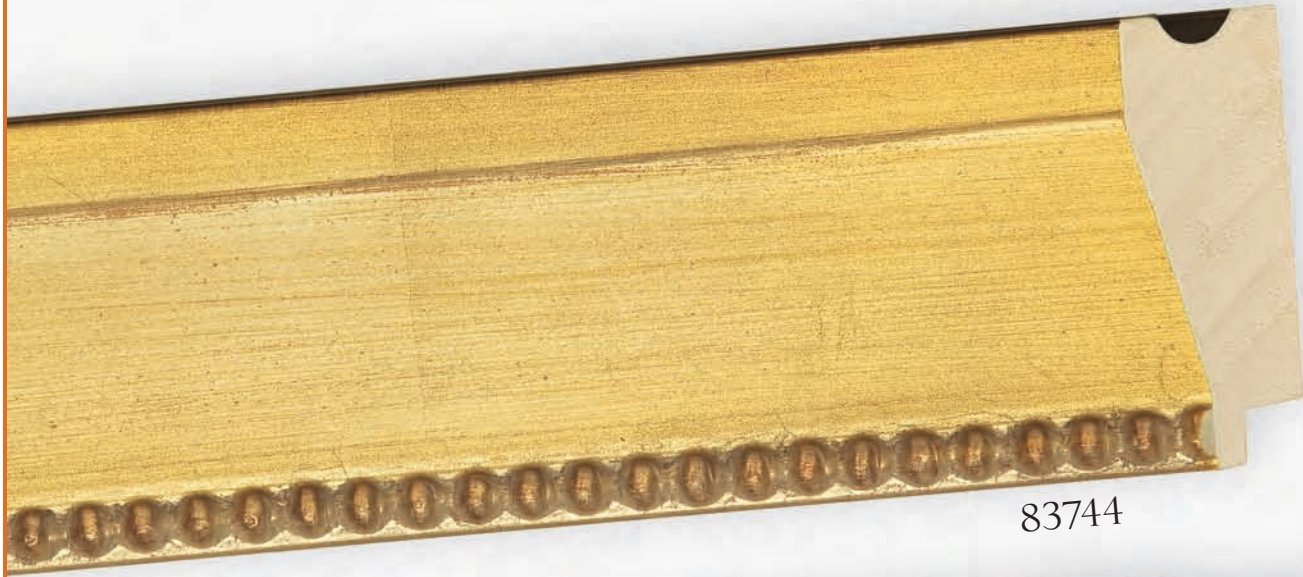

83744

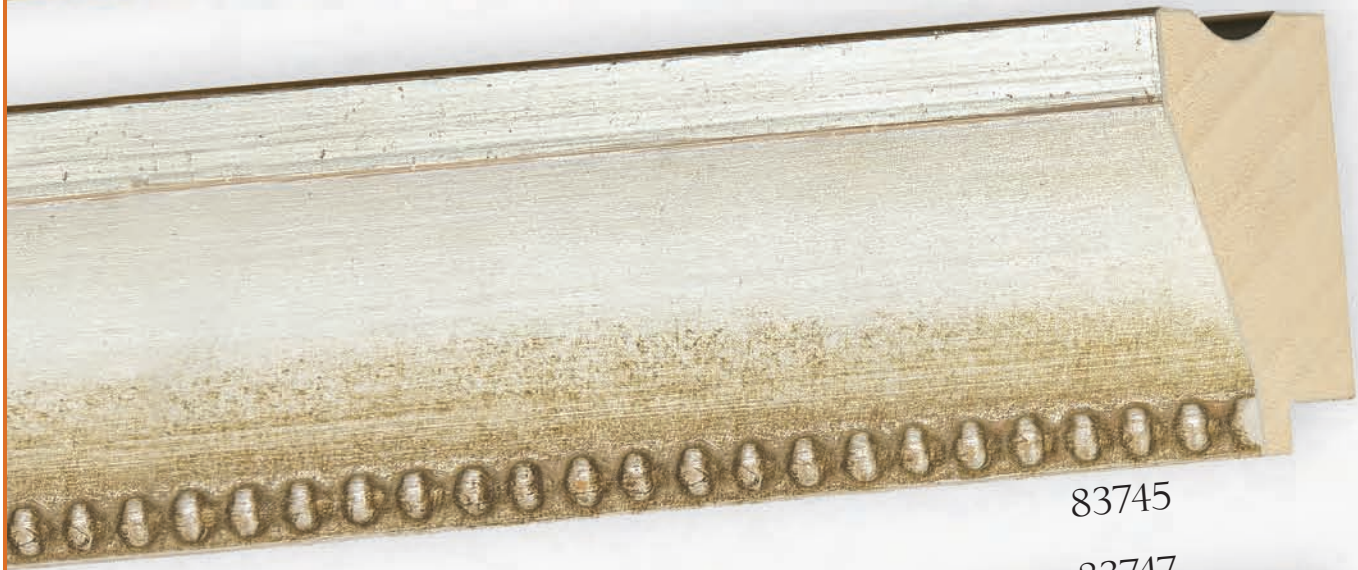

83745

83747



83746





83748



83749



83750



83751





2" rabbet depth • 79880



2" rabbet depth • 79881



7/8" rabbet depth • 79886



7/8" rabbet depth • 79887



79888

7/8" rabbet depth



79889

7/8" rabbet depth



80353



80363



80357



80358



80105 • Ravenswood Collection



80107 • Ravenswood Collection  
St. Augustine Collection



Generations Collection



79746



80379



Generations Collection



79742



79970



Vineyard Collection



St. Augustine Collection

80381



79314



79317



79315



79318



80051



80052



80050



79290



79291



79210



79211



79207



79206



78807



78657



78658



79797



79216



79217



79957



79950



80986



80989



80987





80033



80032



80028

A wood trim sample with a dark, reddish-brown stain and a decorative, multi-line profile.

80034

A wood trim sample with a dark stain and a decorative profile featuring a repeating pattern of small, raised, circular motifs.

79978

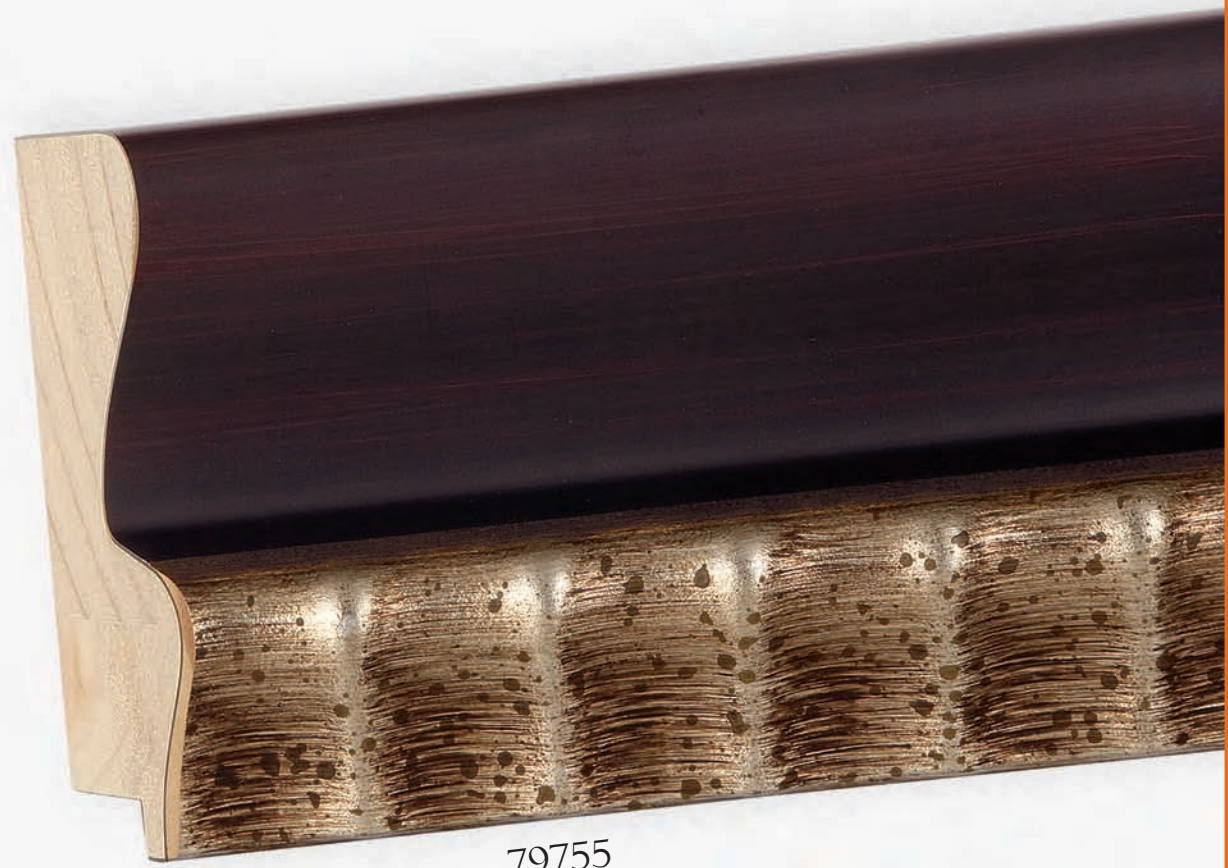
A wood trim sample with a dark stain and a decorative profile featuring a repeating pattern of small, raised, circular motifs.

79755



79763



79764



80072



80056



80055



*Intaglio Collection • 79423*



*Intaglio Collection • 79422*



*Florentine Collection • A80443*

80447



*Florentine Collection*



*78652 • Corinthian Collection*



*78653 • Corinthian Collection*

79783



*Autumn Collection*



80588

80589



80533

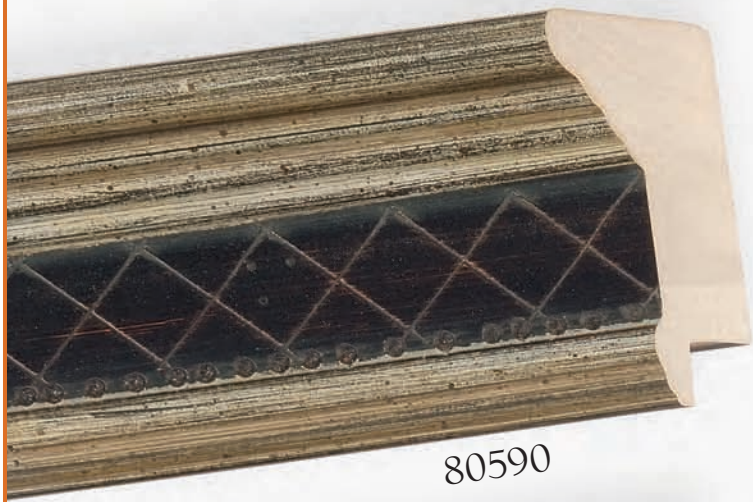

80590



80591



79776



80550



80551



80556



80552



80546



80557



80559

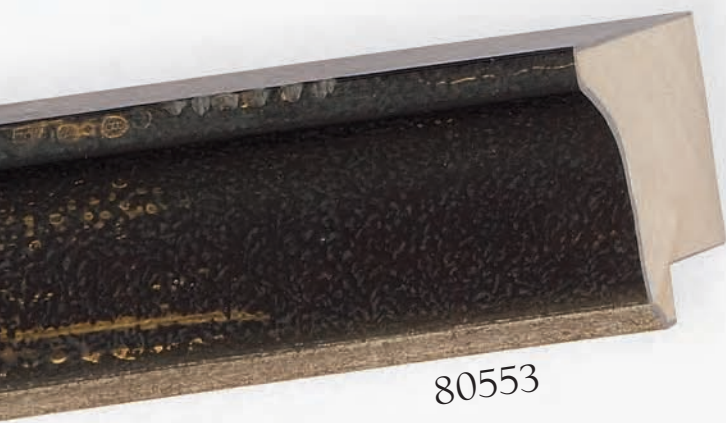

80553



80555

78872

Plum

78874

Walnut

78877

Plum

78879

Walnut

79761

78870

78871

78873

78875

78876

79762



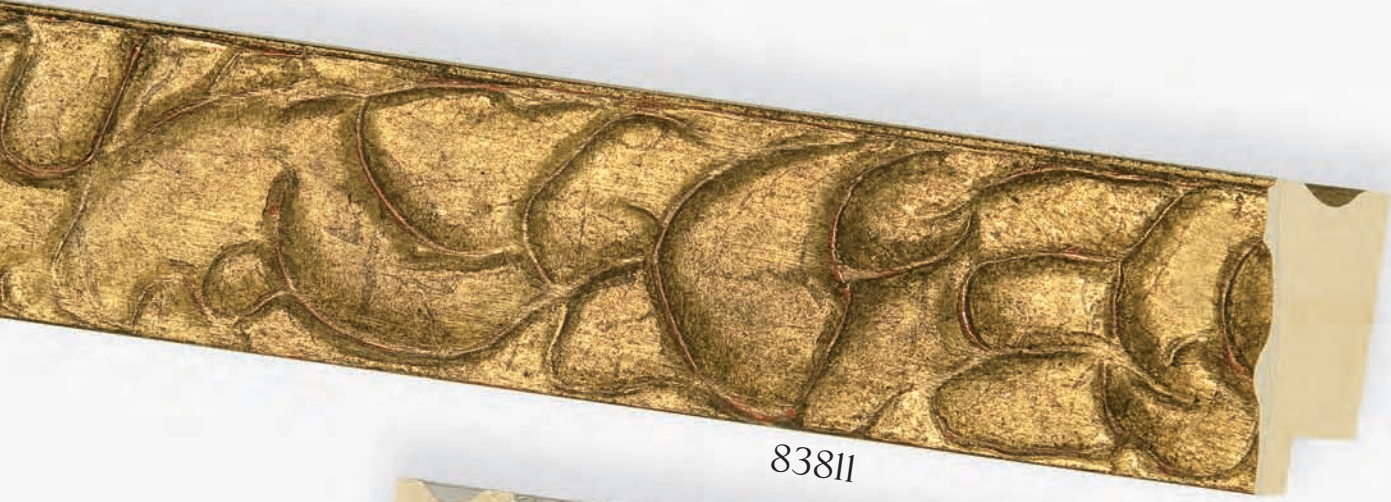

83811



83812



83813



83346



83347





83350



83352



83351

83354



83353

83355





80500



80503



80506



80501



80504



80507



80502



80505



80508



80908

A decorative wood molding sample with a light brown finish. It features a raised, repeating pattern of stylized, interlocking floral or scrollwork motifs along its length. The molding is shown at an angle, with a small piece of light-colored wood attached to its bottom edge.



80909

A decorative wood molding sample with a light brown finish. It features a raised, repeating pattern of stylized, interlocking floral or scrollwork motifs along its length. The molding is shown at an angle, with a small piece of light-colored wood attached to its bottom edge.



80910

A decorative wood molding sample with a dark, almost black finish. It features a raised, repeating pattern of stylized, interlocking floral or scrollwork motifs along its length. The molding is shown at an angle, with a small piece of light-colored wood attached to its bottom edge.



80913

A decorative wood molding sample with a dark, almost black finish. It features a raised, repeating pattern of stylized, interlocking floral or scrollwork motifs along its length. The molding is shown at an angle, with a small piece of light-colored wood attached to its bottom edge.



80911

A decorative wood molding sample with a medium brown finish. It features a raised, repeating pattern of stylized, interlocking floral or scrollwork motifs along its length. The molding is shown at an angle, with a small piece of light-colored wood attached to its bottom edge.



80912

A decorative wood molding sample with a light brown finish. It features a raised, repeating pattern of stylized, interlocking floral or scrollwork motifs along its length. The molding is shown at an angle, with a small piece of light-colored wood attached to its bottom edge.



80915



80914



80916



80922



80923



80924



80925



80514



80511



80517



80616



80020



79960



80021



79961



80022



79962



76288

76289

78850

76281

76282

78832

79248

78833

79249

79277

30047

22047



*fillet • 79340*



*fillet • 78799*



*fillet • 79338*



*fillet • 79339*



*fillet • 77532*



*Jubilee Collection*

30045



*Metropole Collection • 79025*



*Metropole Collection • 79026*



8018

*Jubilee Collection*



8019

*Jubilee Collection*



76201

*Metropole Collection*



79613 • *Jubilee Collection*



76202 • *Metropole Collection*





80129



80132

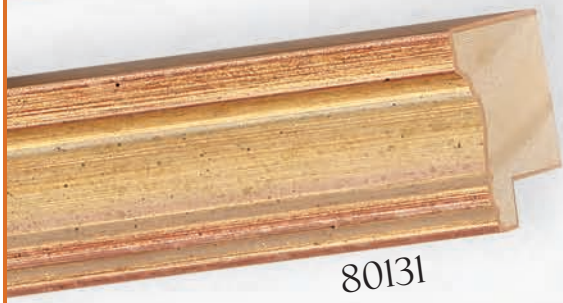

80131



*fillet* • 80140



80138



80136



80135

80139



80372



80373



80223



83656



83657



83658



83659

83662



83663



83664



83665 • floater



83660



83661

1 1/8" floater depth



83666 • floater



83667 • floater



79269



79267



78580



79012



79013



79014



78581



78582



1 1/8" rabbet depth • 79388



1 1/8" rabbet depth • 79389



1 1/8" rabbet depth • 79390



3/4" rabbet depth • 79005



3/4" rabbet depth • 79006



3/4" rabbet depth

79007

79008



3/4" rabbet depth



79027



79028



79386



79387



79752



79827



78655



78656

79135



79136





79015



79016



78770



78771

79009



79011



81031



81032



81033



79380



79381



79385



79635



79636



79378



79382



79383



79696



76273



79379





76268



76269

A76265



A76266



76270



A76267



78998



79165

79000



79167



79168





80122



80123



80120



80127



80126

80124



80125





79937



79936



83570



83572



83571



78638



8209



78816



78592



78820



78637

77000





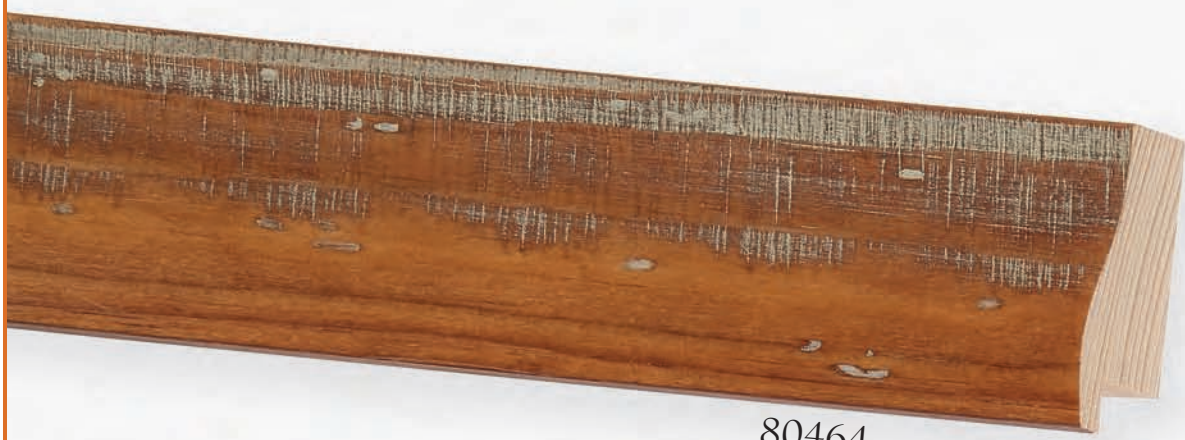

80464



80461



*Montauk Collection • Genuine burl veneer*

80475



80470



80471



80465



80462

*Transverse ash veneer mouldings*





*Transverse ash veneer mouldings*

80793



80783



80788



80784

*Transverse ash veneer mouldings*



80789



80794

80787



80792



80797





83568



83565



83564

*Genuine burl veneer mouldings*



83810



83566



83567

*1 1/8" rabbet depth*



83559



1 1/8" rabbet depth

83562



83560

*Genuine burl veneer mouldings*



83809



83563



83561



83341



83342



83343

*Genuine burl veneer mouldings*



81048



81049



81050

*Genuine burl veneer mouldings*



81051



81052



81053





80957



80961



80960

*Genuine burl veneer mouldings*



80964



80965

80968

80966





83438



83441



83439



83442



83444



83417



83418



83419



79841



79842



81044



81046



81045



81047



79846



79847



78907

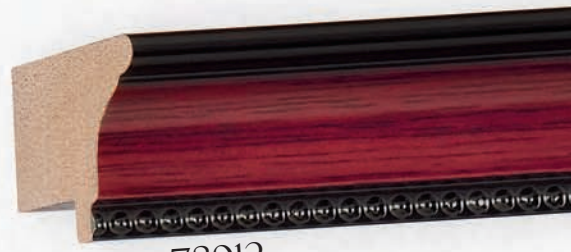

78912



79582



81035



79689



79688



79653



79652



79687



79686



79738



79737



79739



80703

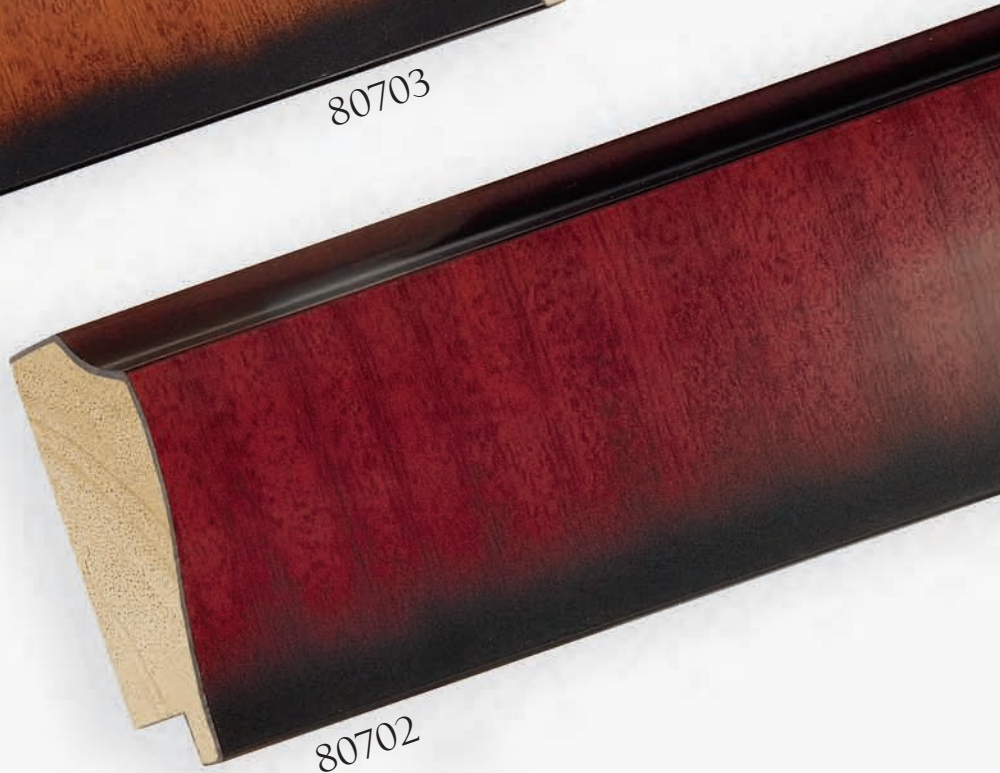

80702

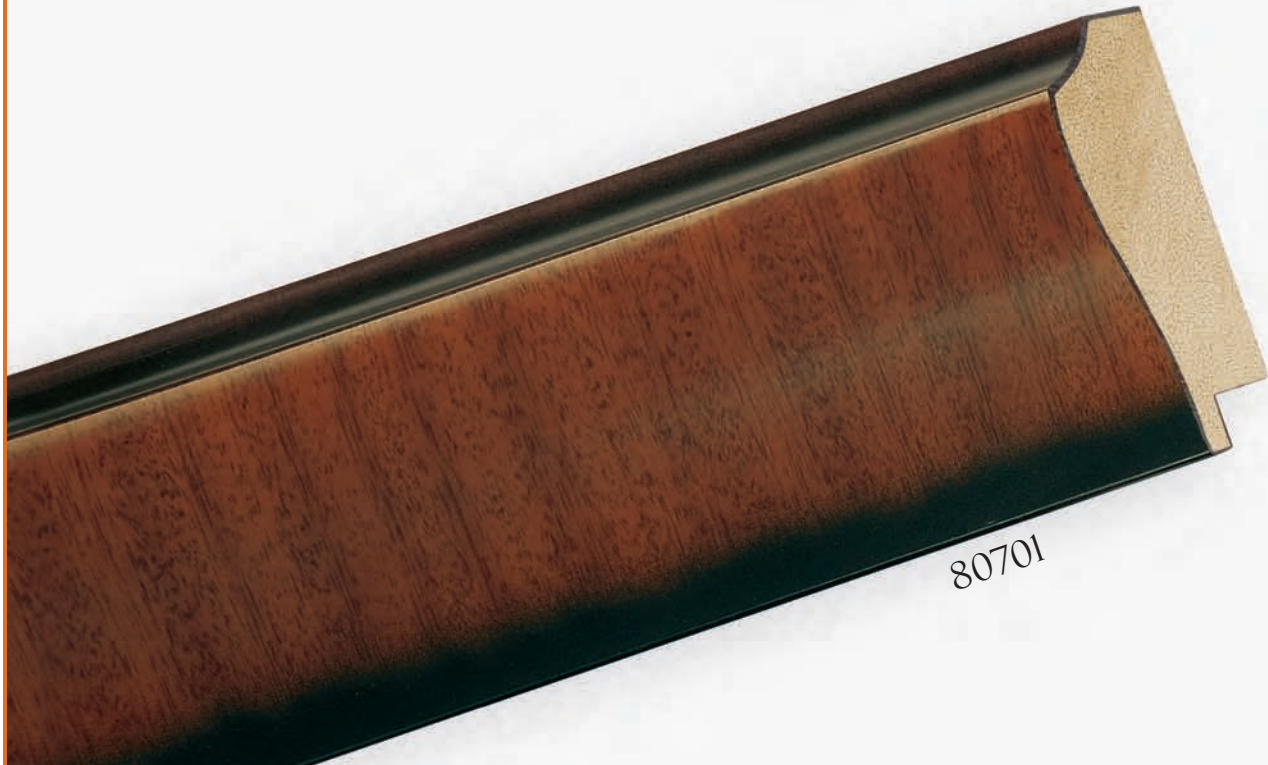

80701



80691



80690



80689

80694



80693



80692







80700



80699



83684



80773 • 2 1/8" rabbet depth



2 1/8" rabbet depth • 80774



78596

78503

78504

78597

79674

79673

79676

79677

78500

78501



79837



79838



79835



79836



80225



80226

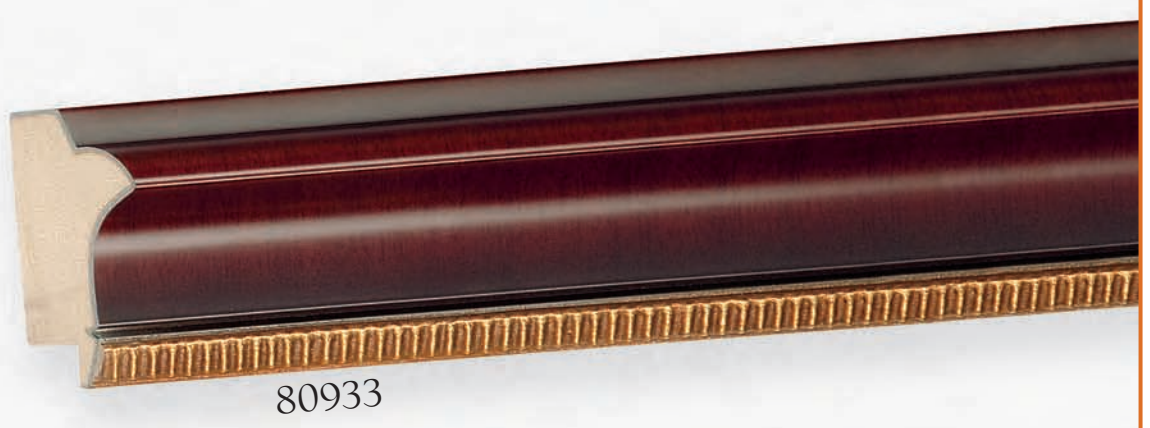

80933



80935



80932

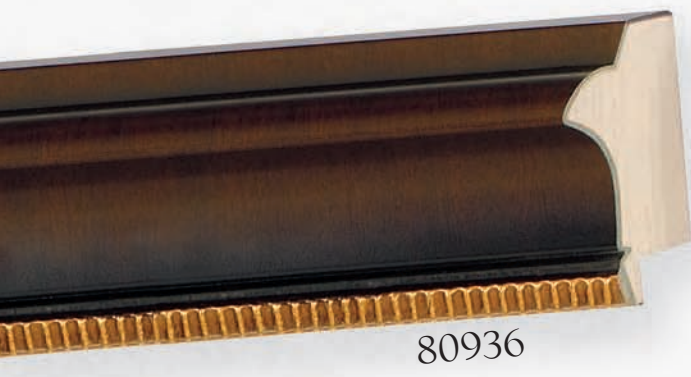

80936

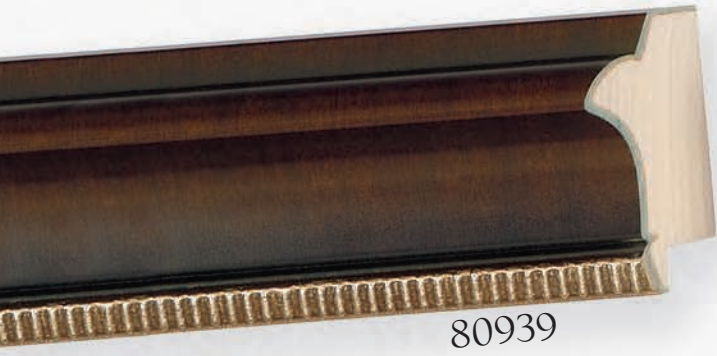

80939



80938

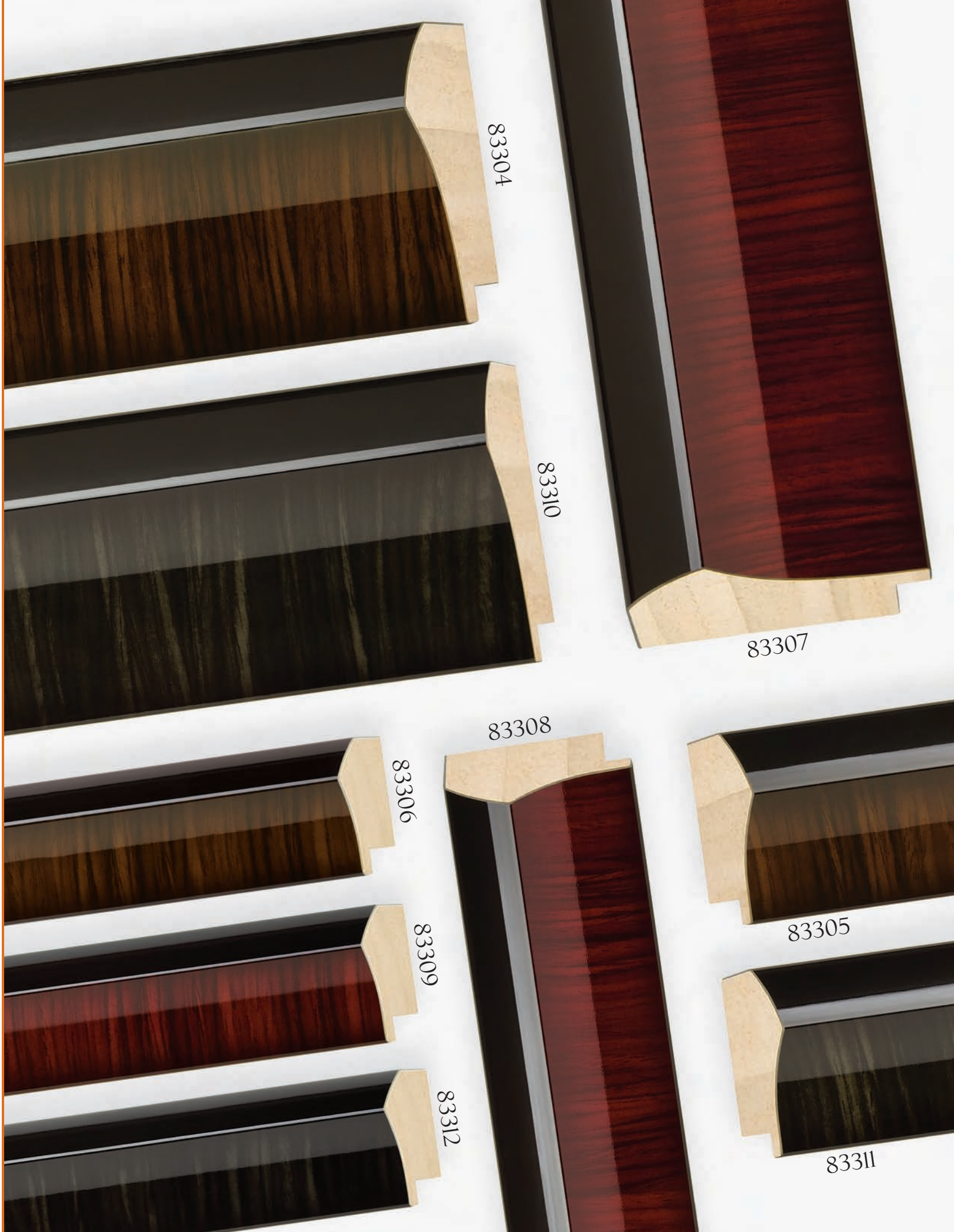



80210



80213



80211



80214



80216



80217

*Transverse maple veneer mouldings*



83550

83551

83552

83553

83554

83555

83556

83557

83558

*1" rabbet depth*

*1" rabbet depth*



83576



83577



83578



83579





*1/2" rabbet depth*

79580



*79257 • 3/4" rabbet depth*



*79263 • 3/4" rabbet depth*



*79262 • 3/4" rabbet depth*

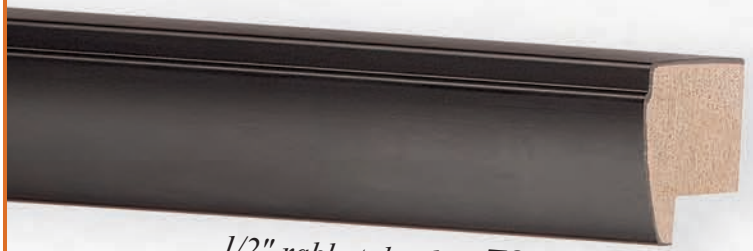

*1/2" rabbet depth • 79575*



*3/4" rabbet depth • 79264*



*3/4" rabbet depth • 79260*

78015



*solid maple • 1 1/8" rabbet depth*

78016



*solid maple • 1 1/8" rabbet depth*



80834

*1/2" rabbet depth*



80835

*1/2" rabbet depth*



80832

*1/2" rabbet depth*



80833

*1/2" rabbet depth*



80820 • *1 1/4" rabbet depth*



80825 • *5/8" rabbet depth*



80826 • *5/8" rabbet depth*

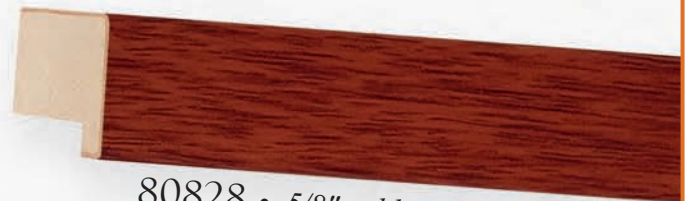

80828 • *5/8" rabbet depth*



80829 • *5/8" rabbet depth*



*1/2" rabbet depth* • 80836



80848

*5/8" rabbet depth*



80830

*5/8" rabbet depth*

Maple veneer mouldings • 3/4" rabbet depth

83673

83674

83675

83676

83677

*Maple veneer mouldings • 1" rabbet depth*



83678

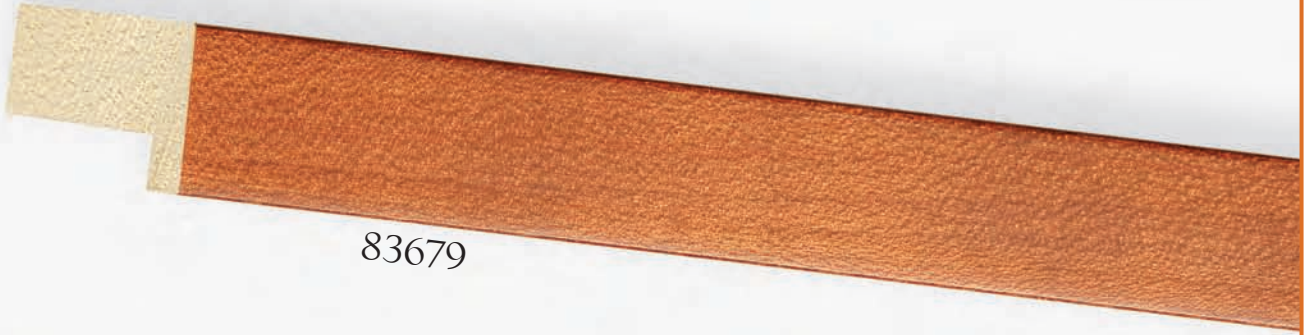

83679



83680



83681



83682

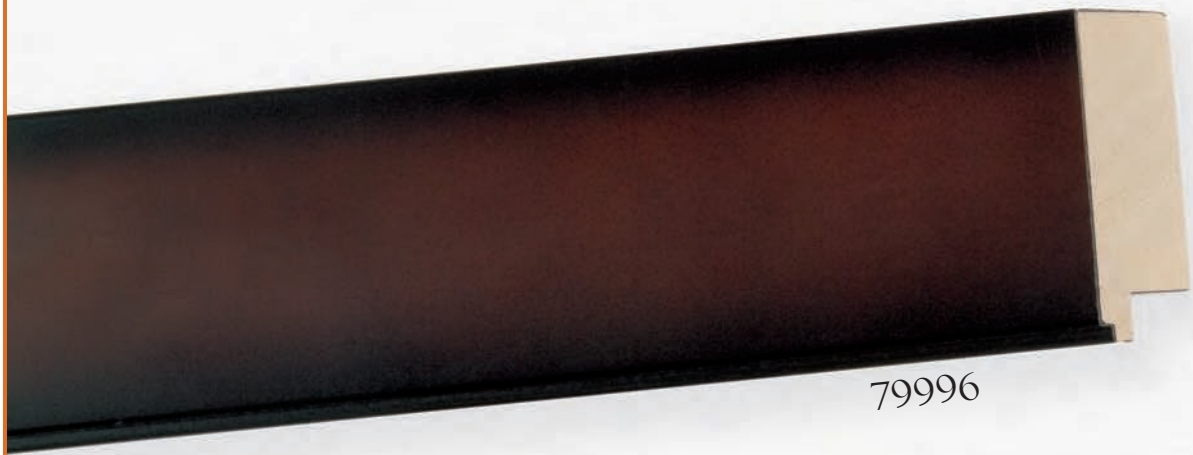

79996

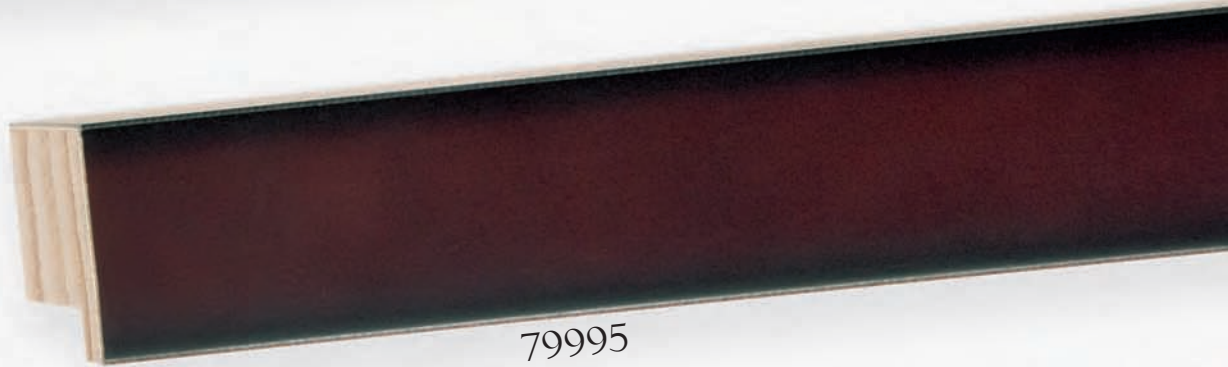

79995



79998

*1 5/8" rabbet depth*



80587 • *1 1/8" floater depth*



80583



80585



80781



80776



80782



80778



80779



83755



83756



83753



83752



83757



83754



83842



83843



83844



83845

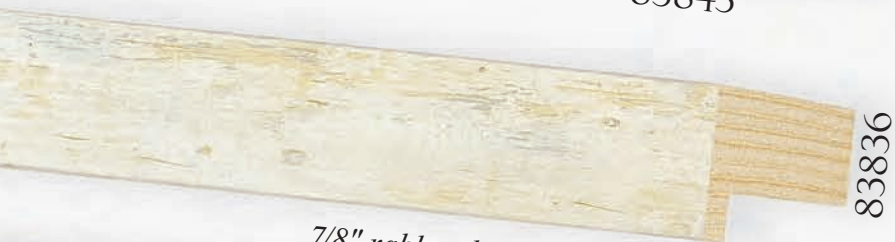

83836

*7/8" rabbet depth*



83837



83846

83838

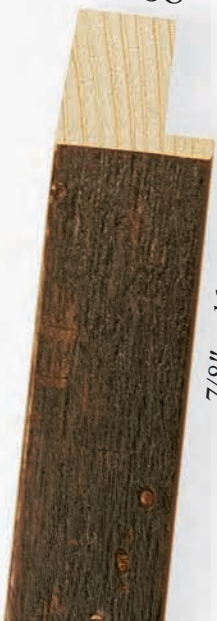

*7/8" rabbet depth*

83839

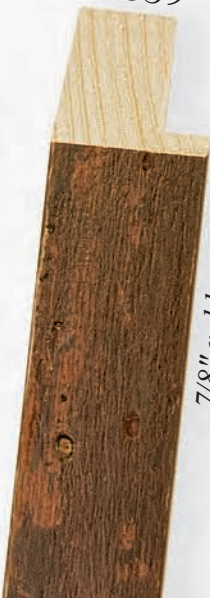

*7/8" rabbet depth*

83840

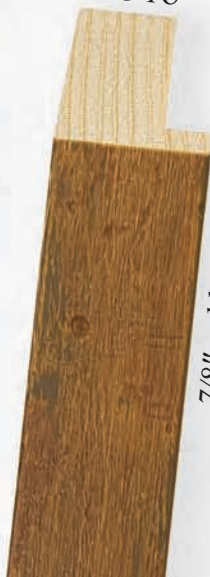

*7/8" rabbet depth*

83841



*7/8" rabbet depth*





83630 • olive wood veneer



83631 • olive wood veneer



83632 • olive wood veneer

83668



83670



83671



83672



83669



83807



83808



83805



83803



83806



83804



80316



80315



80317



83536



83533



83537



83534



83535



83538



83530



83531



83532



79352



79353



79354 • 1 1/4" rabbet depth



79603



79651



79609



79606



79608



79621



79949



79623



80340



80341



80339



80342



80343



80338



83619



83620



83621



83622



83623



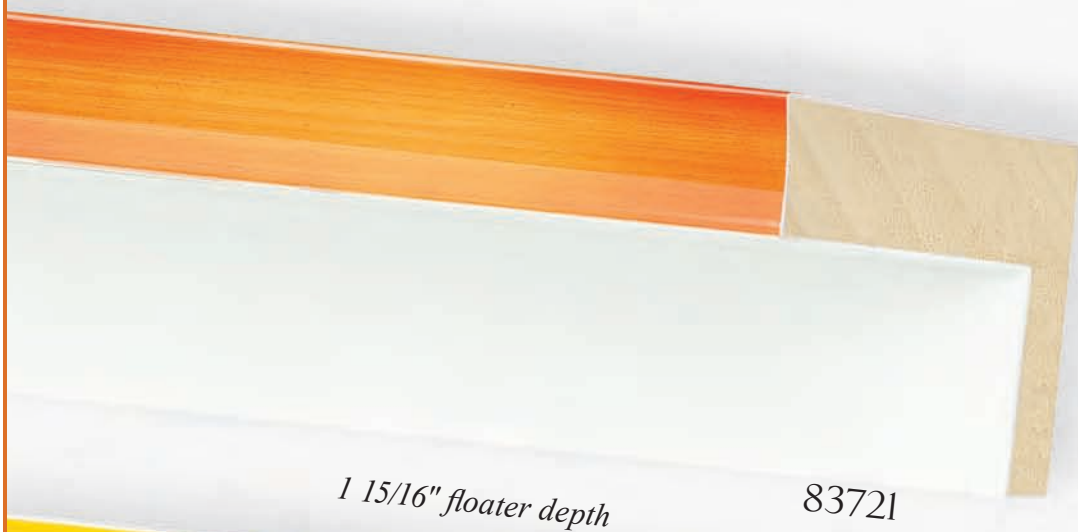

*1 15/16" floater depth*

83721



83724

83722



83720



83724



83723

*1 15/16" floater depth*

*1 15/16" floater depth*



83725



83726



83729



83727



83730



83728



83731



83732



83733



83734



83735



83736



83737



80298



80299



80300



80301



80302



80697



80698



80695



80720



80722



5/8" rabbet depth shadowbox stacker cap moulding

80757

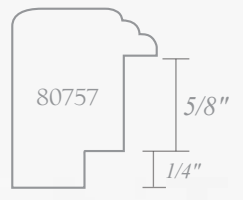

80754 • 1 1/4" height shadowbox stacker



80755 • 2" height shadowbox stacker



2 1/8" rabbet depth • 80772



1 9/16" rabbet depth • 80332

76322



5/8" rabbet depth

78348



5/16" rabbet depth

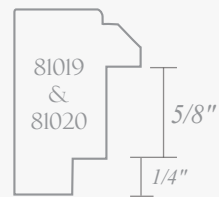
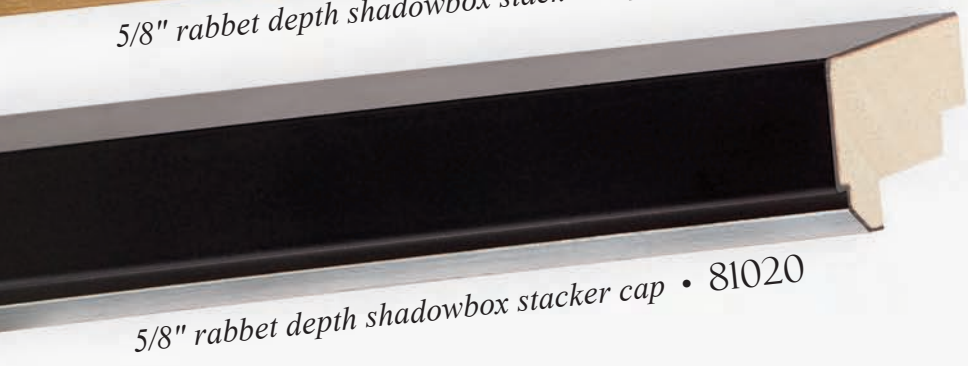



9/16" rabbet depth • 80740

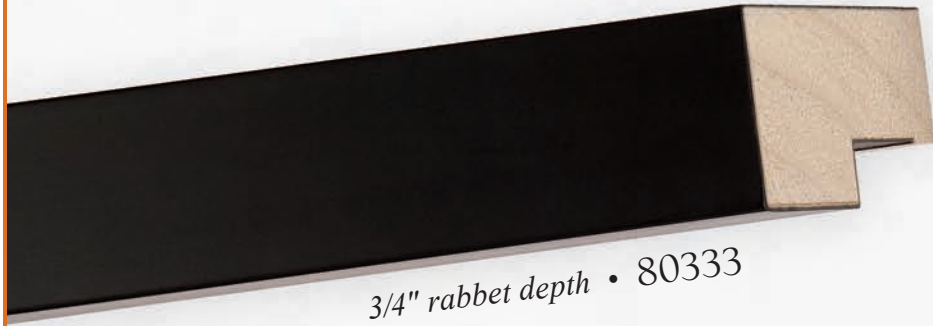

3/4" rabbet depth • 80333



1" rabbet depth

79371



79370

2" rabbet depth



80640



78625

*1/2" rabbet depth*



83345

*1/2" rabbet depth*

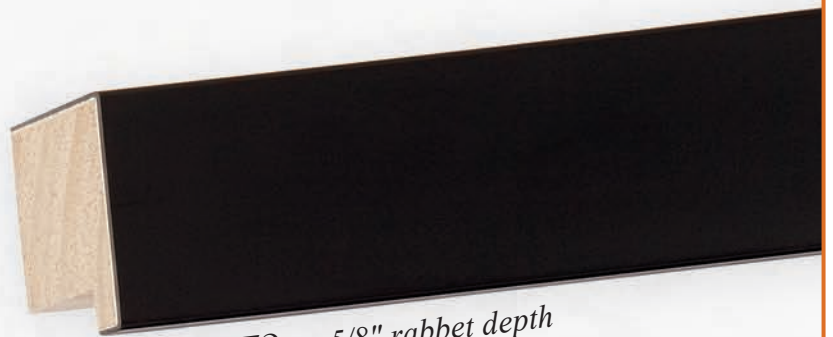

79372 • *5/8" rabbet depth*



78626 • *1" rabbet depth*

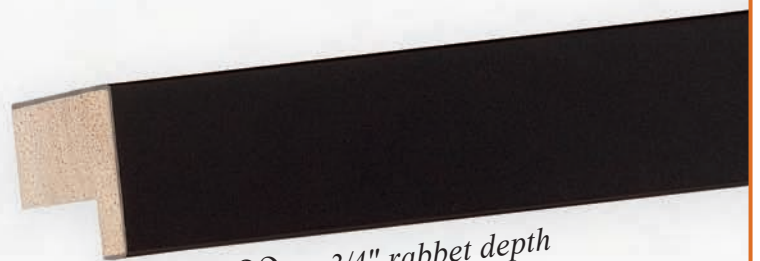

78899 • *3/4" rabbet depth*



*9/16" rabbet depth* • 78627



*5/8" rabbet depth* • 79771

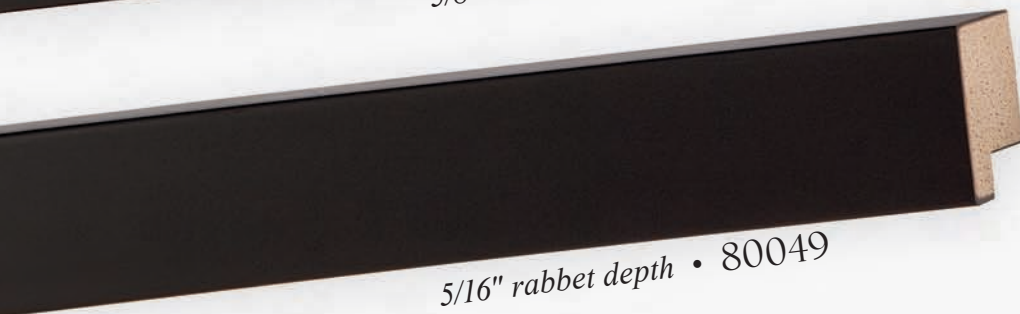

*5/16" rabbet depth* • 80049

80759



*1 1/2" rabbet depth*

80762



*1 1/16" rabbet depth*



3/4" rabbet depth • 80736

9/16" rabbet depth • 80733

80734

13/16" rabbet depth

79766 • 1" rabbet depth

79765 • 13/16" rabbet depth

80765 • 7/8" rabbet depth

80745 • 1/2" rabbet depth

78624

3/4" rabbet depth

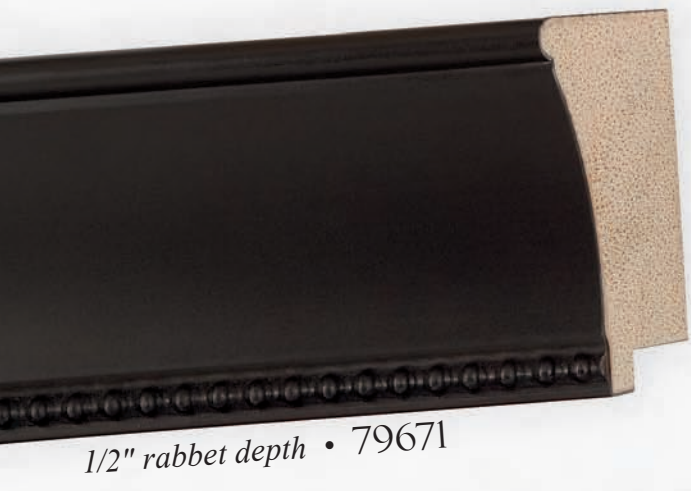



*7/8" rabbet depth*

80742



*1/2" rabbet depth*

80499



*7/8" rabbet depth • 80737*



*79672 • 9/16" rabbet depth*



*5/8" rabbet depth • 80744*

80770



*2 3/8" rabbet depth*

80771



*1 5/16" rabbet depth*



11/16" rabbet depth • 78623



9/16" rabbet depth • 79675



3/8" rabbet depth • 79678

78628

78629



7/16" rabbet depth



1/4" rabbet depth



79975

9/16" rabbet depth



80389

2" rabbet depth



78896 • 7/16" rabbet depth



78898

7/16" rabbet depth



78897

7/16" rabbet depth



79999

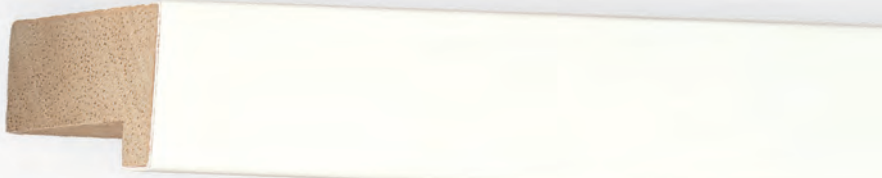

79963

80002



9/16" rabbet depth



9/16" rabbet depth



80743

*9/16" rabbet depth*



80741 • *9/16" rabbet depth*

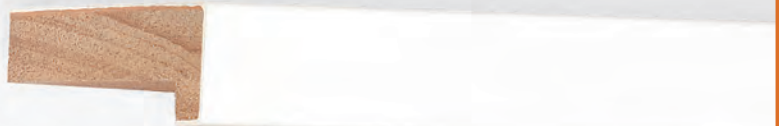

80760 • *1 1/2" rabbet depth*

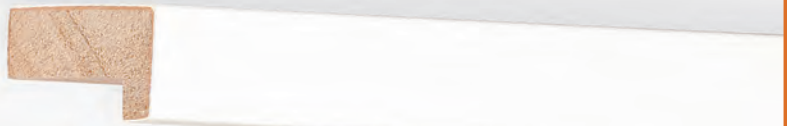

80763 • *1 1/16" rabbet depth*



*3/4" rabbet depth* • 80768



*7/8" rabbet depth* • 80766



*1/2" rabbet depth* • 80746



80735

*13/16" rabbet depth*

*1" rabbet depth • E83453*

*1" rabbet depth • E83454*

E83852

E83853

E83459

E83460

E83493

E83494

*1" rabbet depth • E83465*

*1" rabbet depth • E83466*



E83456 • 1" rabbet depth

E83457 • 1" rabbet depth

E83461

E83462

E83495

E83468 • 1" rabbet depth

E83469 • 1" rabbet depth





E83470 • 1" rabbet depth



1" rabbet depth • E83471



E83473

1" rabbet depth

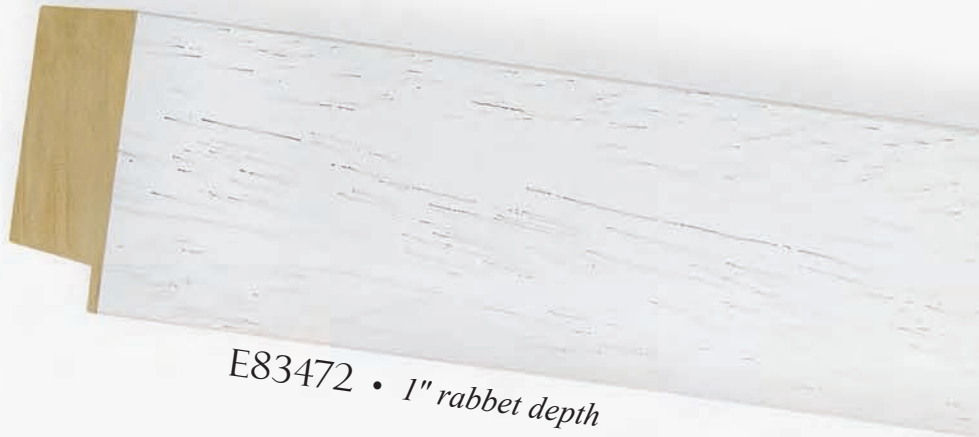

E83472 • 1" rabbet depth



E83464



E83484



E83482



E83498



E83499



E83477



E83478



E83491



E83488



E83489



E83487



E83480

E83486

E83476

E83475

E83485

E83474



E83873 • black



E83872 • charcoal



1" rabbet depth • black • E83871

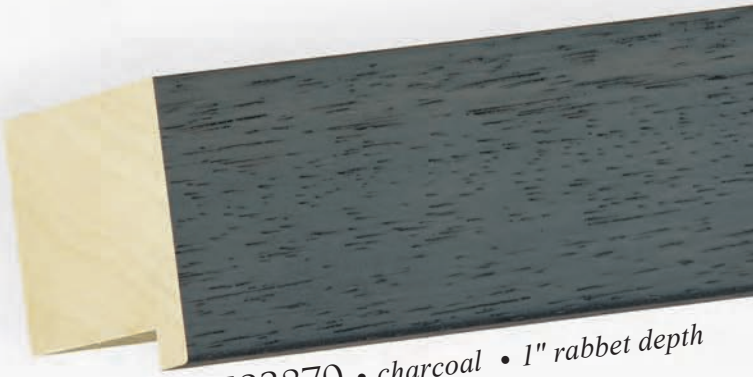

E83870 • charcoal • 1" rabbet depth



E83867 • black



E83866 • charcoal



1" rabbet depth • black • E83863



1" rabbet depth • charcoal • E83862



black • E83859



charcoal • E83858



1" rabbet depth • E83868



E83864



1" rabbet depth

E83865



E83860

1" rabbet depth



E83861

1" rabbet depth



E83869



E83855



E83856



E83518



E83517



E83519



E83523



E83521



78661 • Jazz Collection



78617 • Jazz Collection



80014

Levels Collection



Jazz Collection

79683



Jazz Collection

79685



79077 • Oxford Collection



79074 • Oxford Collection



80017 • Levels Collection



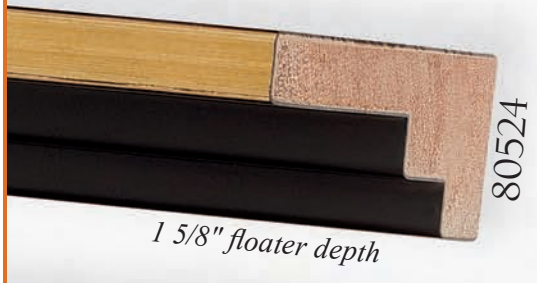

1 5/8" floater depth

80524



1 5/8" floater depth

80525



7/8" floater depth • 80519

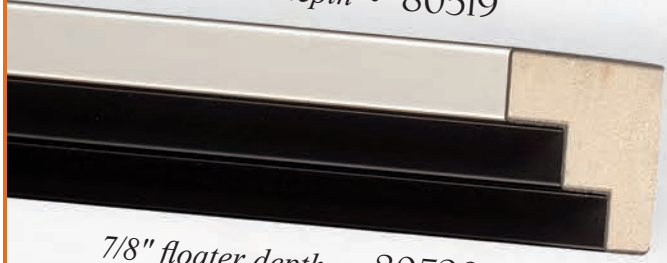

7/8" floater depth • 80520



2 1/4" floater depth • 80639



2 1/4" floater depth • 83683



2 1/4" floater depth • 83901



1 5/8" floater depth

80523



1 5/8" floater depth

80527



7/8" floater depth

80518



7/8" floater depth

80522



80637 • 2 1/4" floater depth



80638 • 2 1/4" floater depth



1 1/4" floater depth • 79376

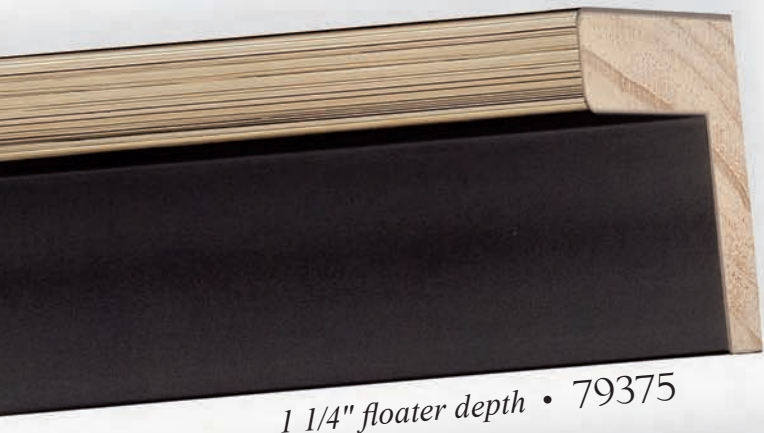

1 1/4" floater depth • 79375



1 1/4" floater depth • 79374

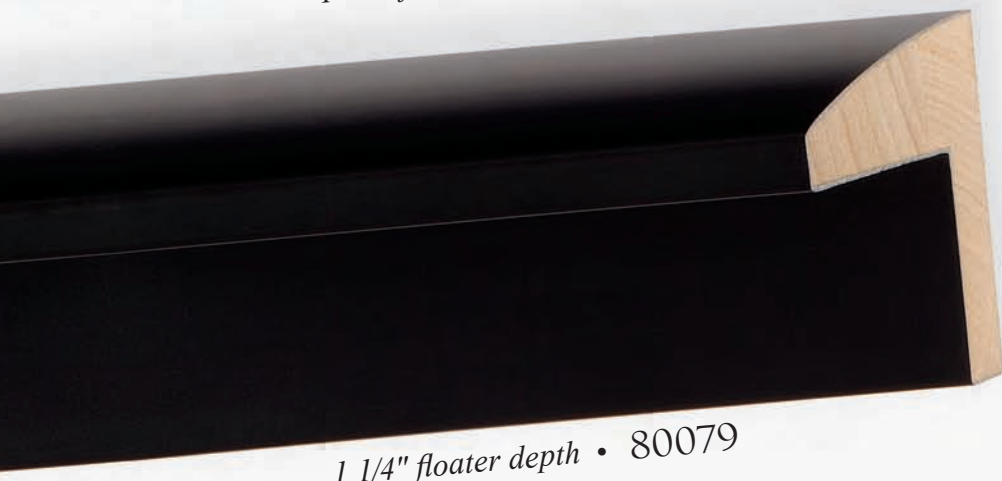

1 1/4" floater depth • 80079



1 9/16" floater depth

83540



1 9/16" floater depth

83539



79377 • 1" floater depth

83541



1" floater depth \* Floatmate® Floater



raw gesso liner • 79205



white linen liner

80940



tan linen liner

79200



79203

raw gesso liner



79201

raw gesso liner



80941

white linen liner



79198

*white linen liner*

79199

*tan linen liner*

79196

*white linen liner*

79197

*tan linen liner*

*white linen liner • 79194*

*tan linen liner • 79195*

*79192 • tan linen liner with gold lip*

*79191 • tan linen liner with gold lip*



79170

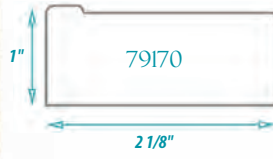

79169



gallery wrap stretcher • 80382

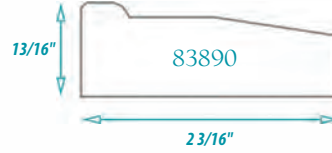
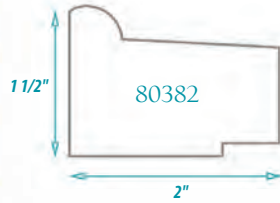

83890



83394

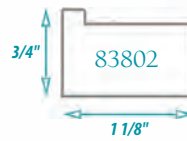
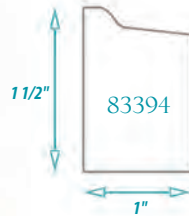

83802



dual-height stretcher • 83395

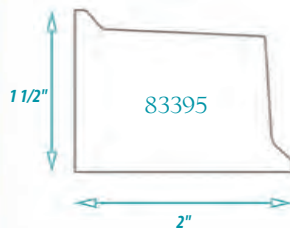

83393 • dual-height stretcher

# COATIMATE™



## Transform best-selling shadowbox mouldings into striking cost-effective floater frames!

**When you order any FloatMate Moulding, you get the 83541 floater at ½ price!**

- If you buy length, you get one bundle of the 83541 floater at **50% off** of the **length** price.
- If you buy **chop**, you get the 83541 floater at **50% off** of the **chop** price
- If you buy **join**, you get the 83541 floater at **50% off** of the **chop** price and we will join the floater to the frame at no charge!

Omega FloatMate pricing example:

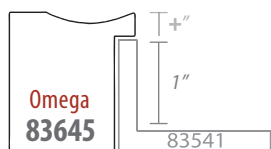

	<b>Box</b>	<b>Length</b>	<b>Chop</b>	<b>Join</b>
Allure 83645	3.04	5.07	8.81	11.96
<b>Floater 83541</b>		1.24	3.02	3.02
<b>▶ Total</b>		<b>6.31</b>	<b>11.83</b>	<b>14.98</b>



	<b>Box</b>	<b>Length</b>	<b>Chop</b>	<b>Join</b>
<b>▶ Competitor's Example A</b>	6.13	8.84	13.39	18.47

Competitor's similar size floaters

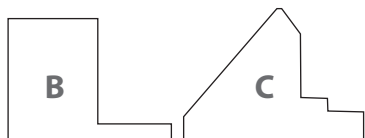

	<b>Length</b>	<b>Chop</b>	<b>Join</b>
<b>▶ Competitor's Example B</b>	8.02	15.93	N/A
<b>▶ Competitor's Example C</b>	10.93	17.61	N/A

All pricing examples shown are US\$ as of 2016.

### Other attractive FloatMate combinations:

All prices are list prices before any discounts. Your prices should be lower.

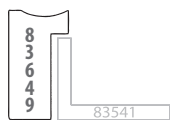

	<b>Box</b>	<b>Length</b>	<b>Chop</b>	<b>Join</b>
Allure 83649	1.96	3.27	6.66	9.35
<b>Floater 83541</b>		1.24	3.02	3.02
<b>Total</b>		4.51	9.68	12.37



	<b>Box</b>	<b>Length</b>	<b>Chop</b>	<b>Join</b>
Venue 83299	2.57	4.28	8.37	11.21
<b>Floater 83541</b>		1.24	3.02	3.02
<b>Total</b>		5.52	11.39	14.23



	<b>Box</b>	<b>Length</b>	<b>Chop</b>	<b>Join</b>
Cirrus 83357	2.53	4.22	8.29	11.11
<b>Floater 83541</b>		1.24	3.02	3.02
<b>Total</b>		5.46	11.31	14.13

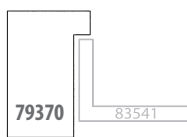

	<b>Box</b>	<b>Length</b>	<b>Chop</b>	<b>Join</b>
Midnight 79370	2.68	4.46	8.04	11.29
<b>Floater 83541</b>		1.24	3.02	3.02
<b>Total</b>		5.70	11.06	14.31



**79998 + Floater 83541**



**80332 + Floater 83541**



**80772 + Floater 83541**



**79880 + Floater 83541**



**79881 + Floater 83541**



**80773 + Floater 83541**



**83707 + Floater 83541**



**83708 + Floater 83541**



**80774 + Floater 83541**





7  
9  
3  
8  
8

**79388 + Floater 83541**

83541



7  
9  
3  
8  
9

**79389 + Floater 83541**

83541



7  
9  
3  
9  
0

**79390 + Floater 83541**

83541



8  
0  
4  
0  
8

**80408 + Floater 83541**

83541



8  
0  
4  
0  
9

**80409 + Floater 83541**

83541



8  
0  
4  
0  
7

**80407 + Floater 83541**

83541



8  
3  
7  
0  
9

**83709 + Floater 83541**

83541



80628

**80628 + Floater 83541**

83541



80630

**80630 + Floater 83541**

83541



**83644 + Floater 83541**



**83645 + Floater 83541**



**83646 + Floater 83541**



**83647 + Floater 83541**



**83648 + Floater 83541**



**83649 + Floater 83541**



**83387 + Floater 83541**



**83388 + Floater 83541**



**79354 + Floater 83541**



83567 **83567 + Floater 83541**



83562 **83562 + Floater 83541**

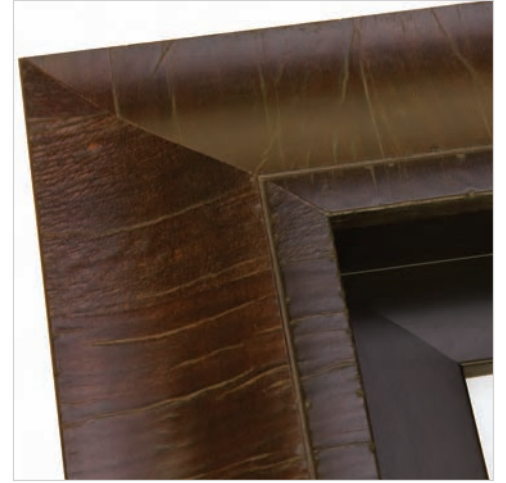

83641 **83641 + Floater 83541**



80795 **80795 + Floater 83541**



80796 **80796 + Floater 83541**



80785 **80785 + Floater 83541**



80790 **80790 + Floater 83541**



80791 **80791 + Floater 83541**



80786 **80786 + Floater 83541**



**83357 + Floater 83541**



**83356 + Floater 83541**



**83361 + Floater 83541**



**78016 + Floater 83541**



**83299 + Floater 83541**



**83298 + Floater 83541**



**78015 + Floater 83541**



**83703 + Floater 83541**

83703 Matte Greige  
also in Matte Black (83702)  
and Matte White (83704)



**83705 + Floater 83541**

83705 Gloss Black  
also in Gloss White (83706)

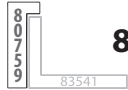

**80759 + Floater 83541**



**80762 + Floater 83541**



**80770 + Floater 83541**

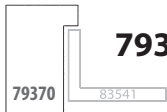

**79370 + Floater 83541**

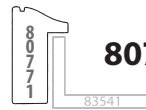

**80771 + Floater 83541**

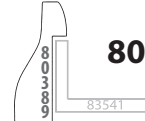

**80389 + Floater 83541**

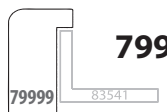

**79999 + Floater 83541**

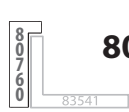

**80760 + Floater 83541**

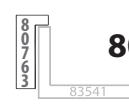

**80763 + Floater 83541**



*Gallery  
Frames*

ΩMEGA+

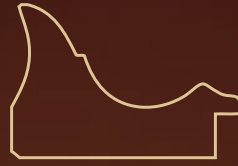

2 1/4" Width

*F* RAME 90 2 1/4"  
*Hand Applied Gold Leaf Finish*

*F* RAME 92 2 1/4"  
*Black with Red Rub Finish  
and Hand Applied Gold Leaf*

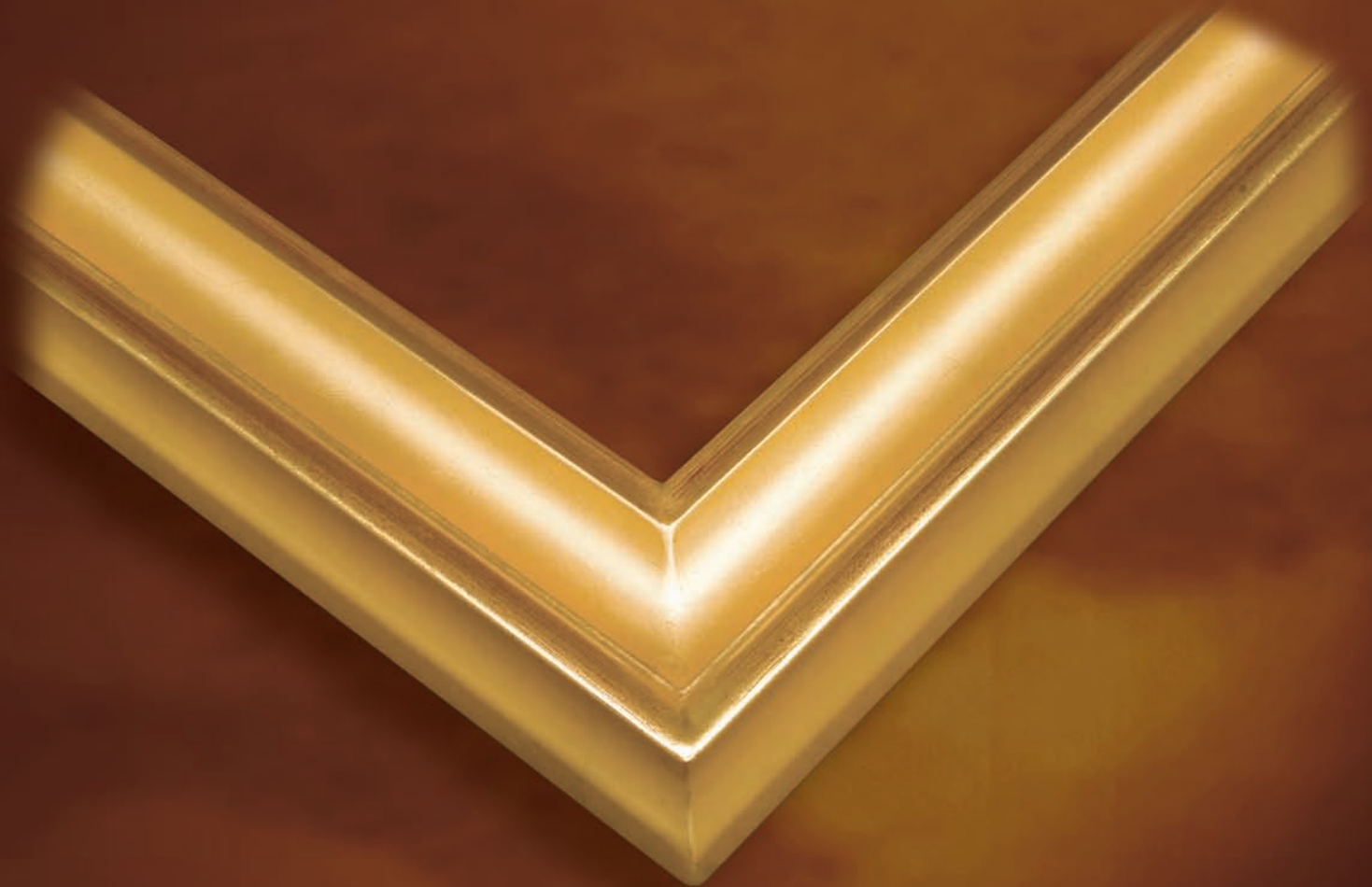



*F* RAME 109 2 1/2"  
*Hand Applied Gold Leaf Finish*

*F* RAME 110 2 1/2"  
*Black with Red Rub Finish  
and Hand Applied Gold Leaf*



*2 1/2" Width*



*3 1/2" Width*

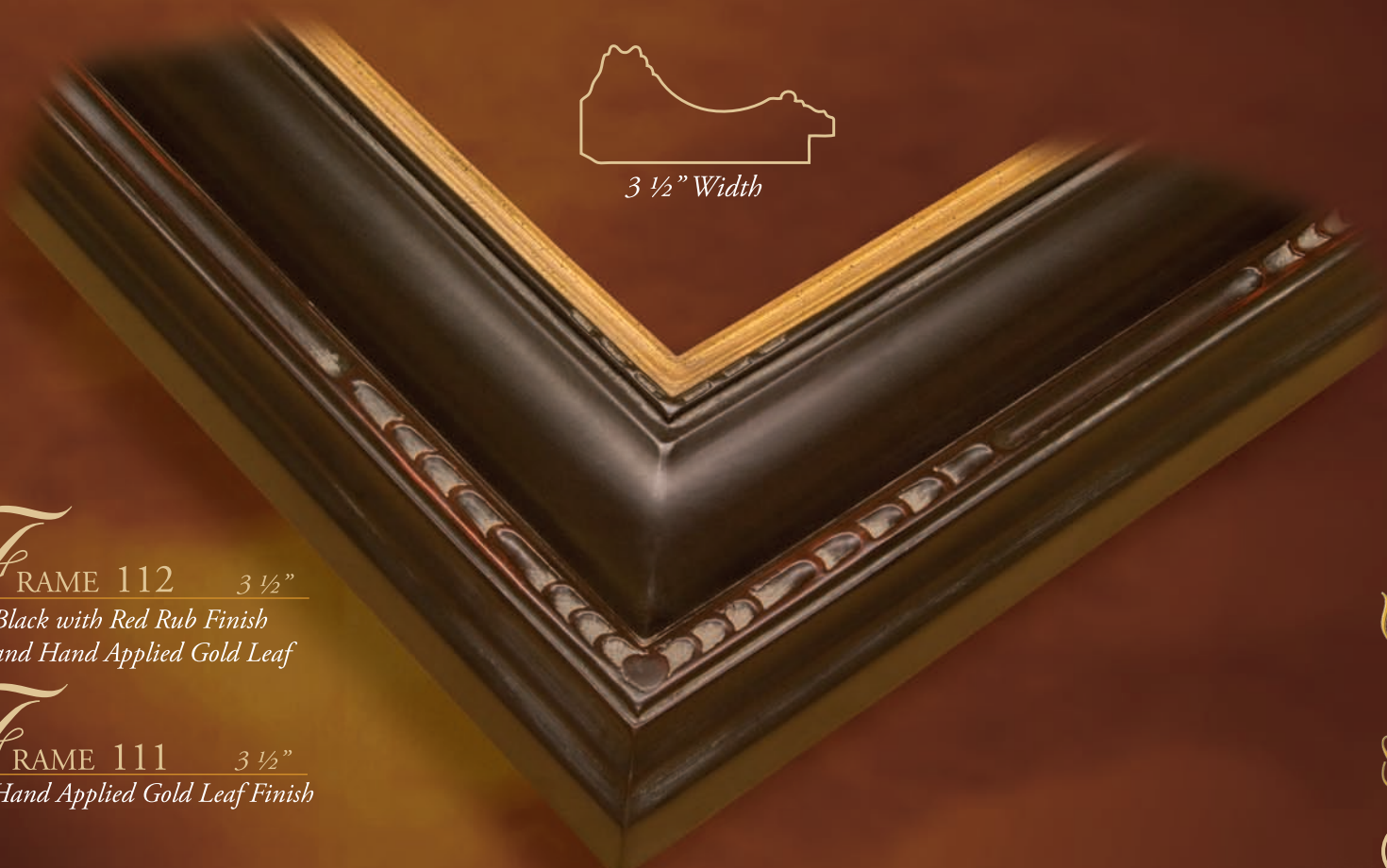

*F* RAME 112 3 1/2"  
*Black with Red Rub Finish  
and Hand Applied Gold Leaf*

*F* RAME 111 3 1/2"  
*Hand Applied Gold Leaf Finish*





*F* RAME 115  
*Hand Applied Gold Leaf Finish*

*F* RAME 117  
*Black with Red Rub Finish  
and Hand Applied Gold Leaf*



*3 1/2" Width*



*F* RAME 118  
*Hand Applied Gold Leaf Finish*

*F* RAME 119  
*Hand Applied Silver Leaf Finish*

*F* RAME 120  
*Black with Red Rub Finish  
and Hand Applied Gold Leaf*



*2" Width*

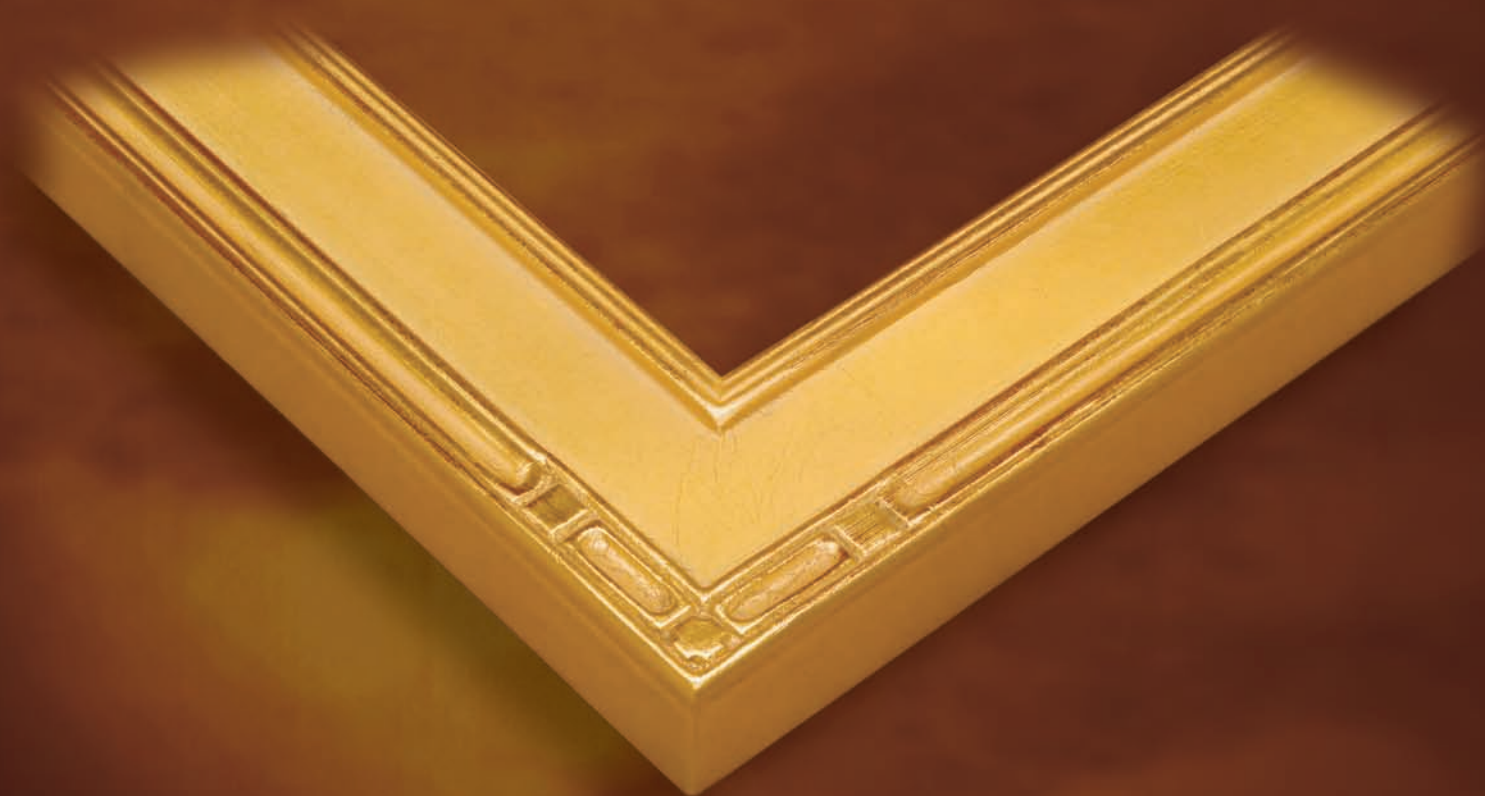



*F* RAME 121

*Black with Red Rub Panel  
and Hand Applied Gold Leaf*

*F* RAME 122

*Black with Red Rub Panel  
and Hand Applied Silver Leaf*



*2 5/8" Width*

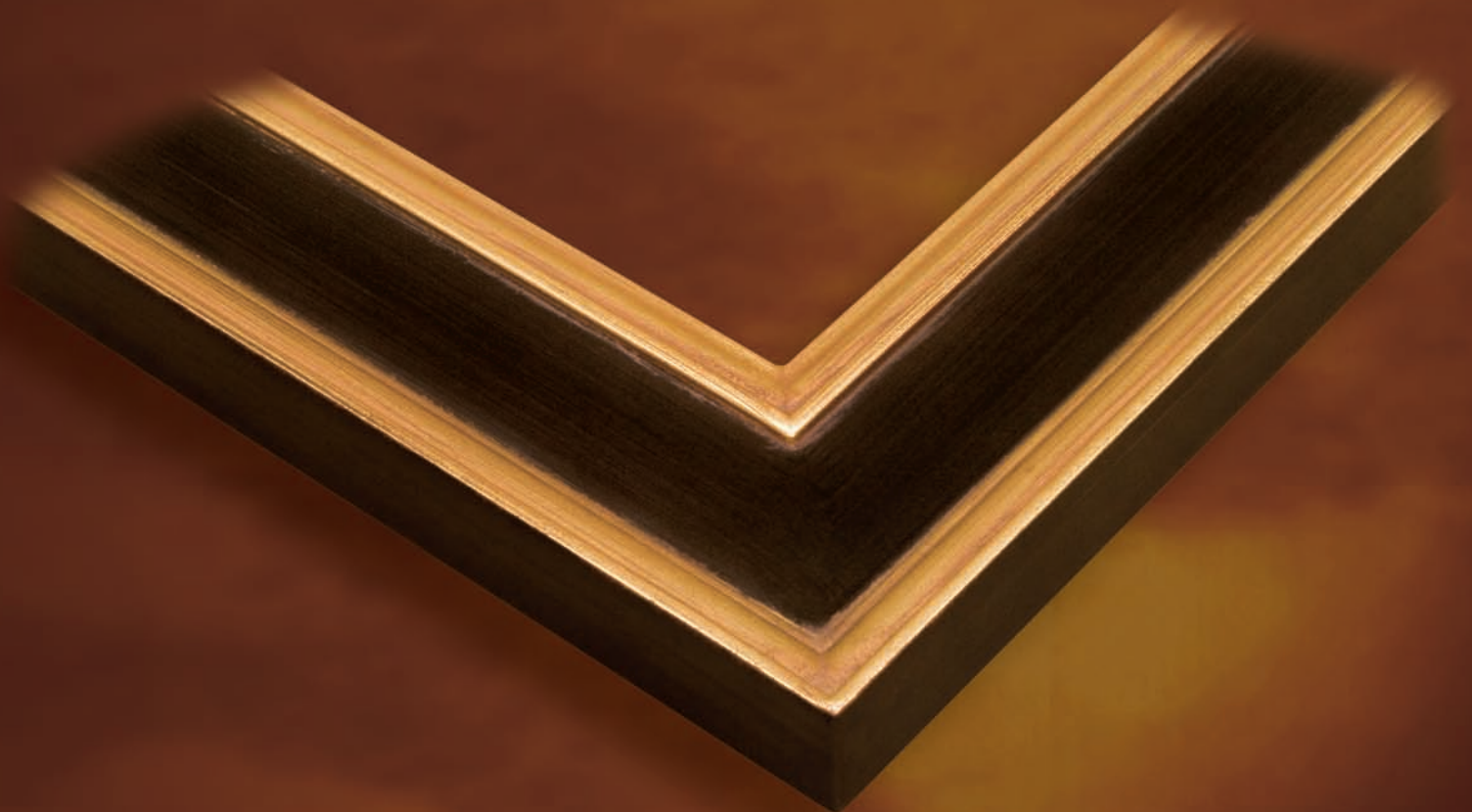

*F* RAME 108

*Black with Red Rub Finish  
and Hand Applied Gold Leaf*



*3 3/4" Width*

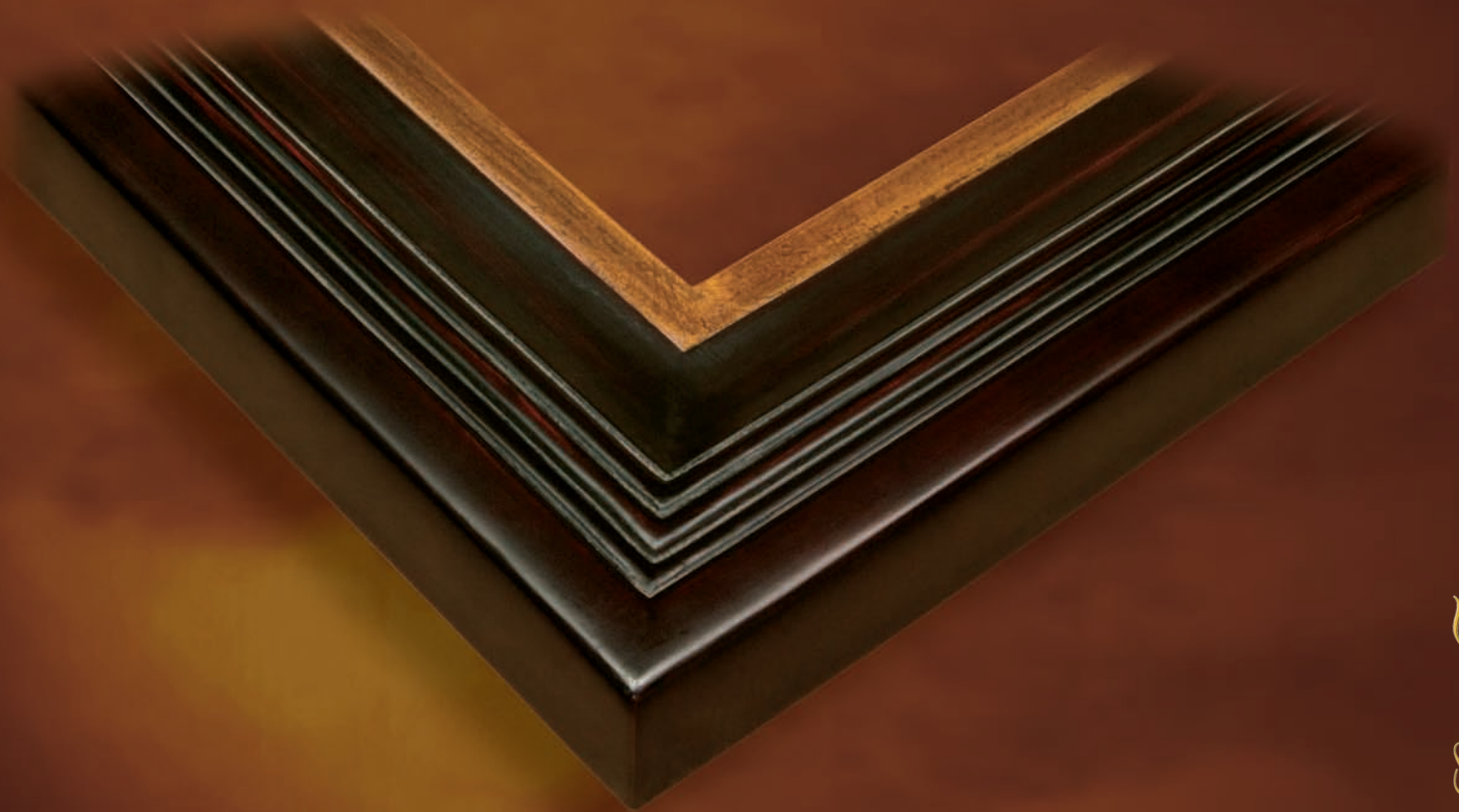



*F* RAME 56  
*Hand Applied Gold Leaf Finish*

*F* RAME 57  
*Hand Applied Silver Leaf Finish*

*F* RAME 58  
*Black and Gold  
Hand Burnished Finish*



*3 1/4" Width*



*F* RAME 69  
*Hand Applied Gold Leaf Finish*



*3 1/4" Width*





*F* RAME 71  
*Hand Applied Gold Leaf Finish*

*F* RAME 72  
*Hand Applied Silver Leaf Finish*

*F* RAME 73  
*Black and Gold*  
*Hand Burnished Finish*



*3 1/2" Width*



*F*RAME 74

*Hand Applied  
Gold Leaf Finish*

*F*RAME 75

*Hand Applied  
Silver Leaf Finish*

*F*RAME 76

*Black and Gold  
Hand Burnished Finish*

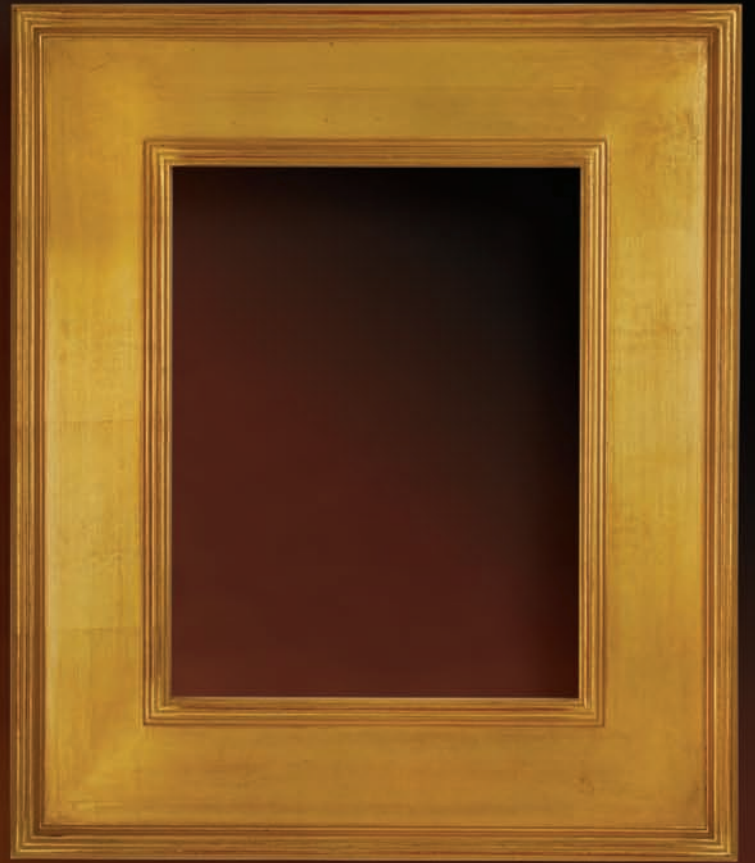

*4" Width*

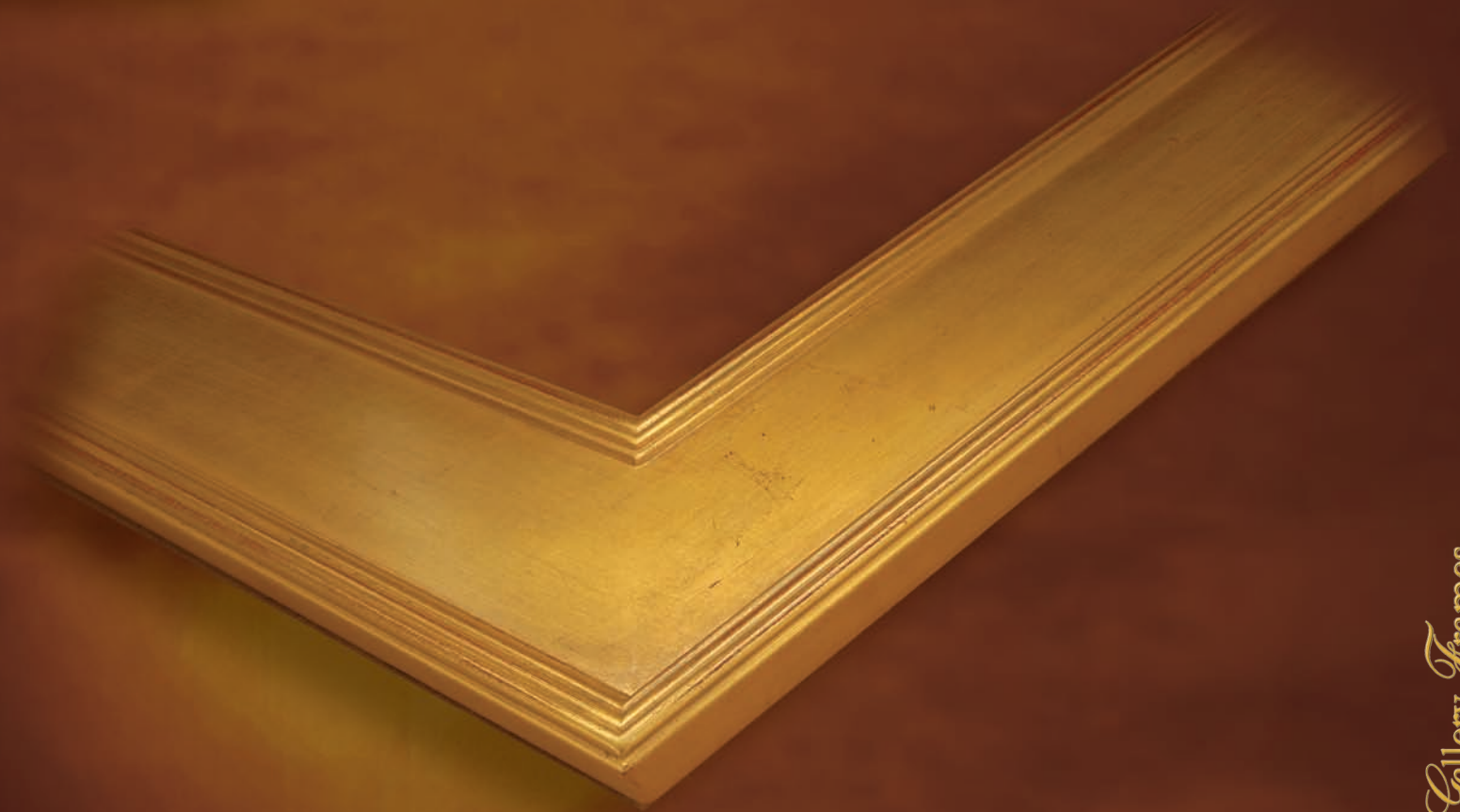





*F* RAME 81  
*Hand Applied Gold Leaf Finish*



*2 3/4" Width*

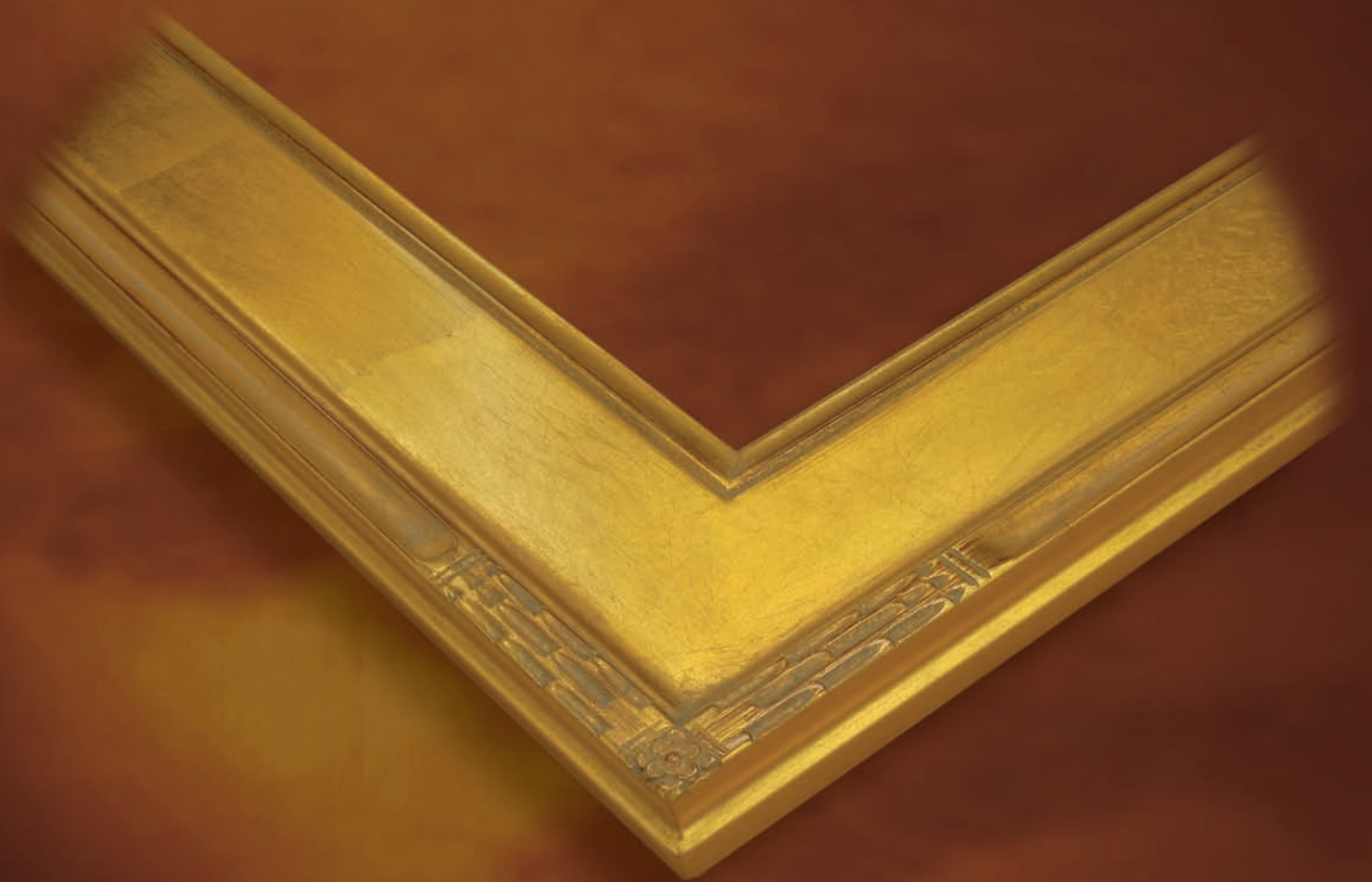



*F* RAME 24  
*Hand Applied Gold Leaf Finish*

*F* RAME 26  
*Hand Applied Silver Leaf Finish*



2" Width

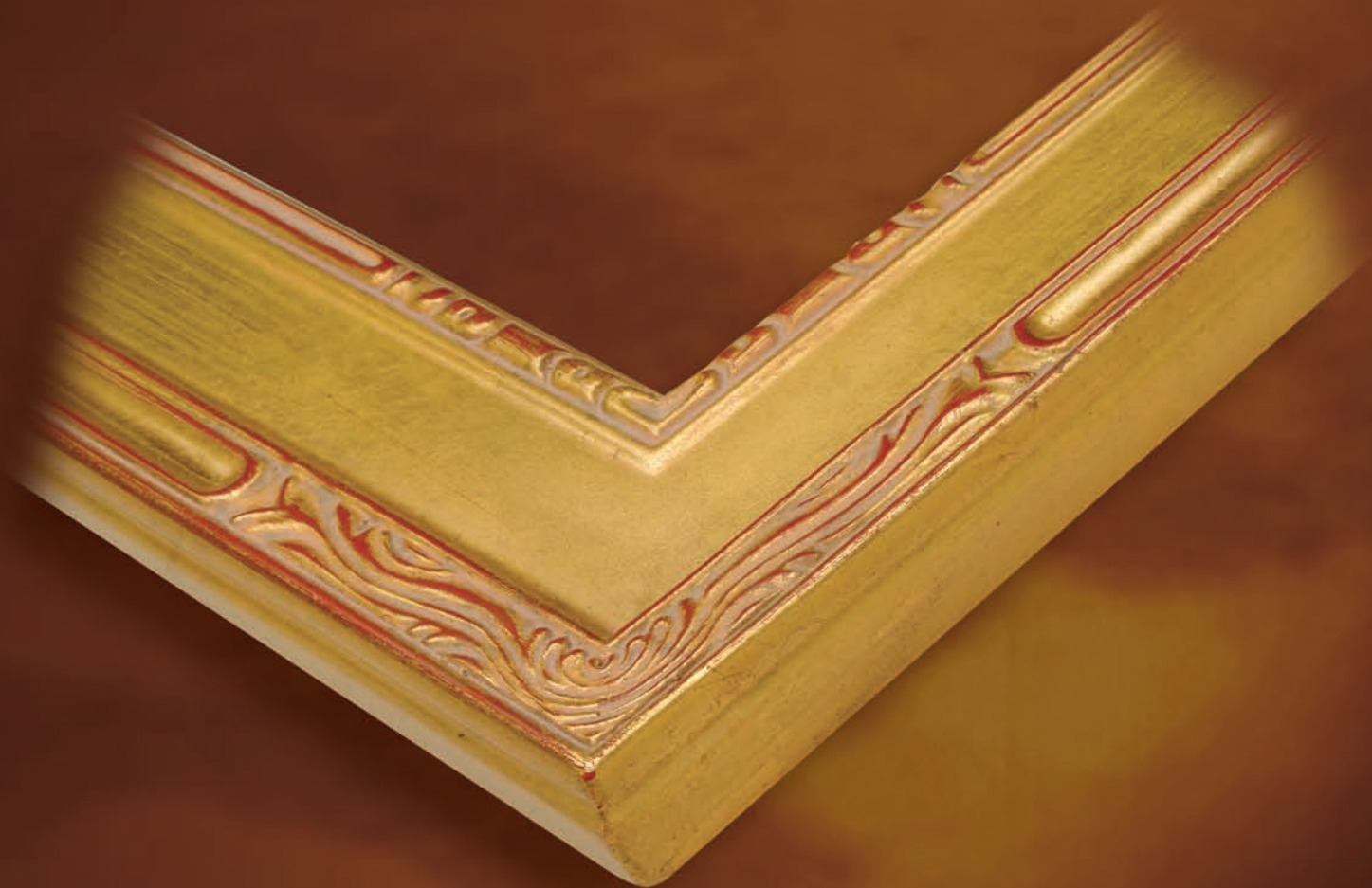



*F* RAME 20  
*Hand Applied Gold Leaf Finish*

*F* RAME 22  
*Hand Applied Silver Leaf Finish*

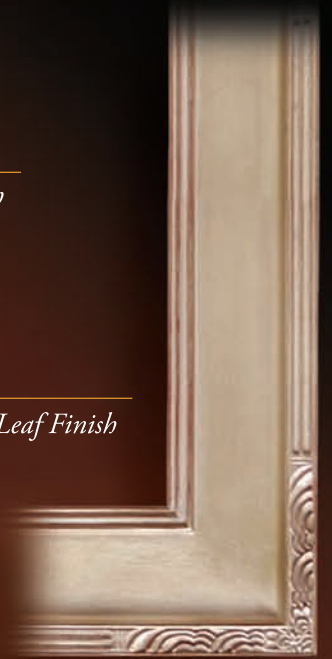

*3 3/4" Width*





*F* RAME 28  
*Hand Applied Gold Leaf Finish*

*F* RAME 30  
*Hand Applied Silver Leaf Finish*



*2 1/2" Width*

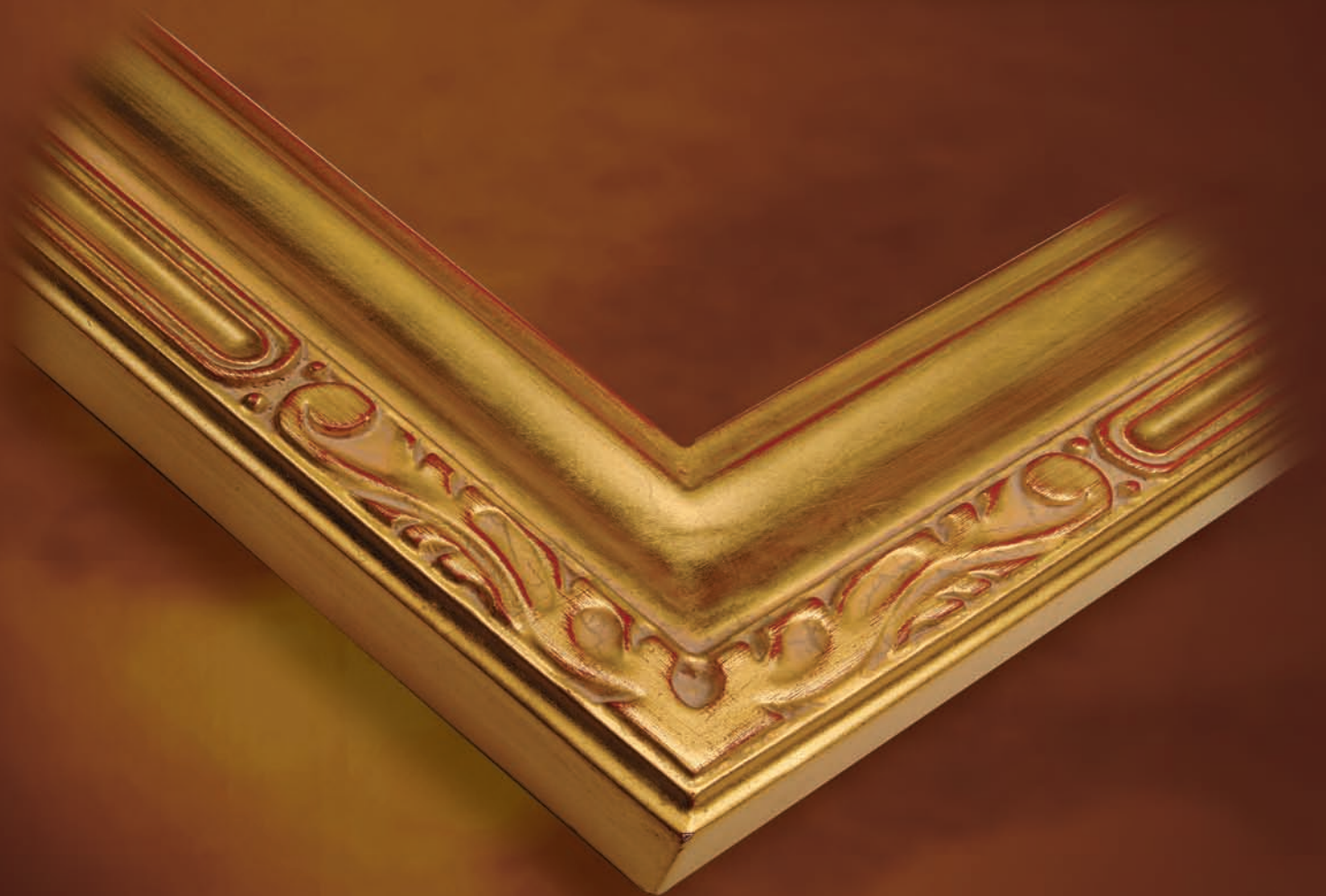



*F* RAME 36  
*Hand Applied Gold Leaf Finish*

*F* RAME 38  
*Hand Applied Silver Leaf Finish*



*2" Width*

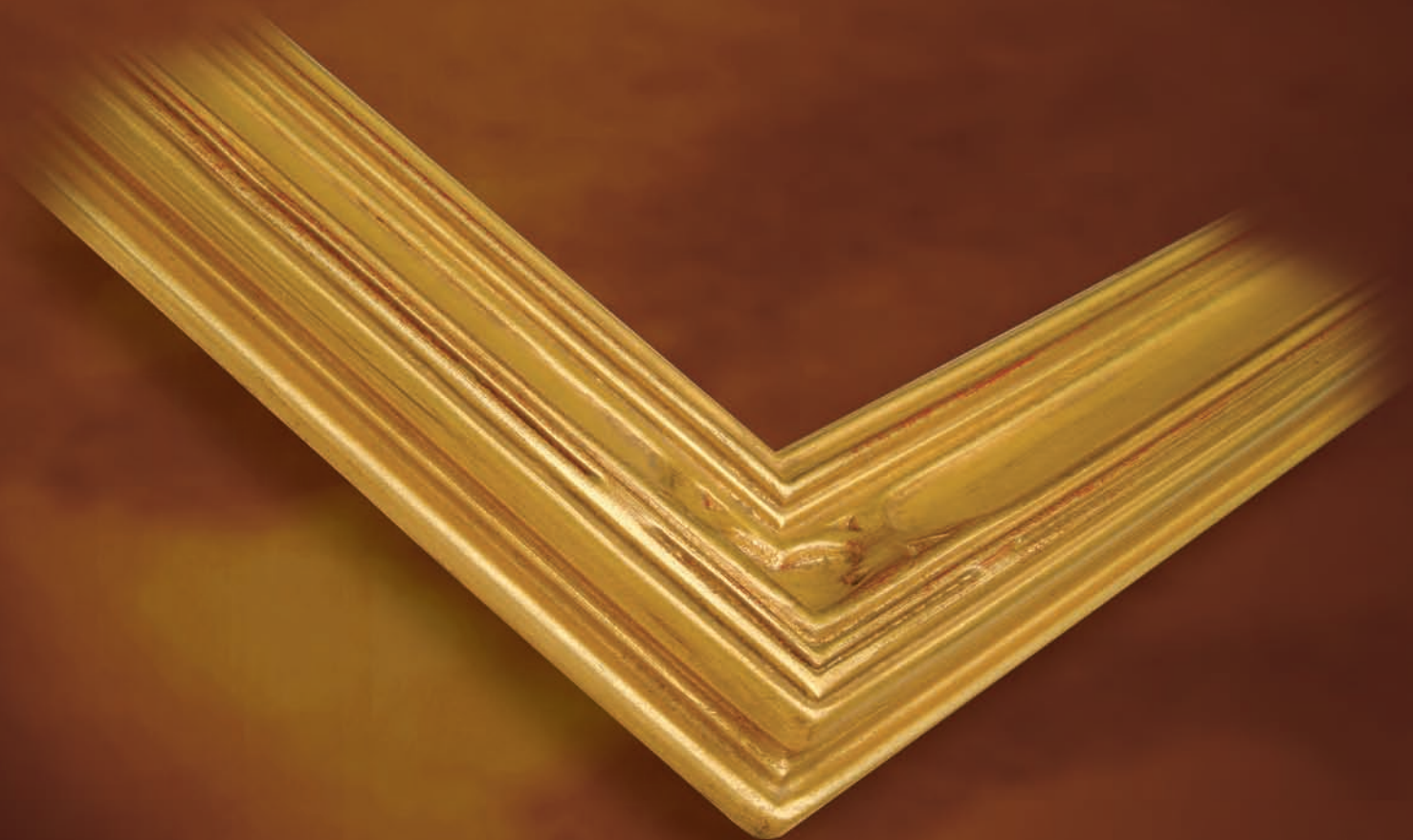



*F* RAME 40  
*Hand Applied Gold Leaf Finish*

*F* RAME 42  
*Hand Applied Silver Leaf Finish*

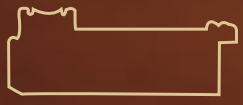

*3" Width*





*F* RAME 80

*Black and Gold  
Hand Burnished Finish*

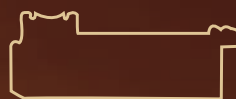

*3" Width*





**ΩMEGA<sup>+</sup>**  
**RPS** <sup>TM</sup>  
Recycled Polystyrene Mouldings





P83210

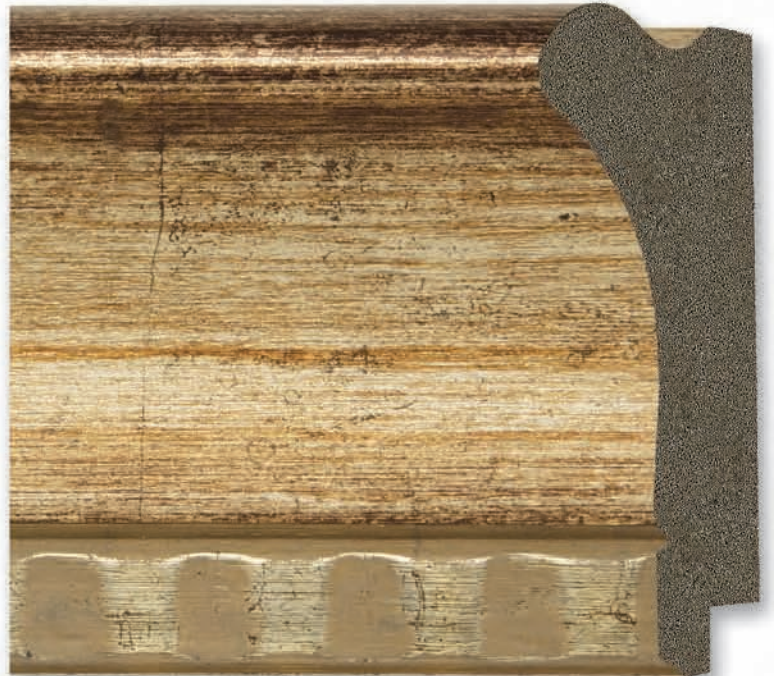

P83208



P83214



P83211



P83212



P83874



P83875



P83876



P83877



P80231



P80294



P80244



P80259



P83327



P83280



P83326



P83276



P80295

P80297



P80238



P80254



P80255



P83241



P83242



P83243



P83238



P83239



P83401



P83402





P83337



P83221



P83220



P83915 • *Gloss White*



P83914



P83271



P83272



P83216



P83215



P83218



P83217



P83223



P83222



P83225



P83224



*Floater • P83329*



*Floater • P83330*



*Floater • P83331*



*Floater • P83332*



*Floater • P83333*



*Floater • P83334*



*Floater • P83335*



*Floater • P83336*



*Floater • P83847*

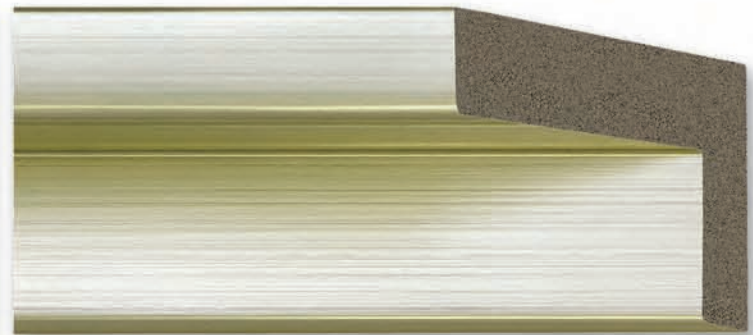

*Floater • P83848*



P83432



P83431



P83428



P83427



P83421



P83422



P83274



P83434

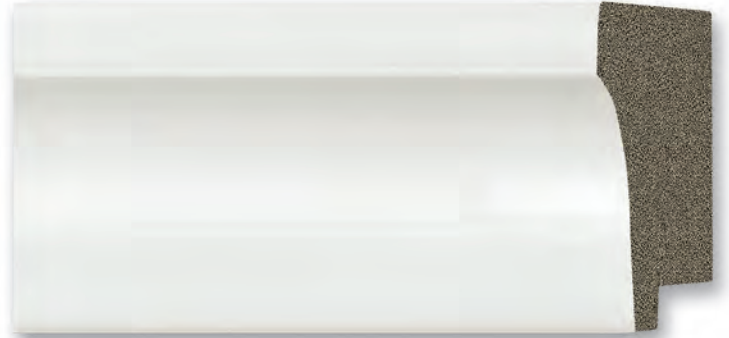

P83435 • *Gloss White*



P83429



P83430 • *Gloss White*



P83426 • *Gloss White*



P83420



P83405



P83406



P83408



P83409

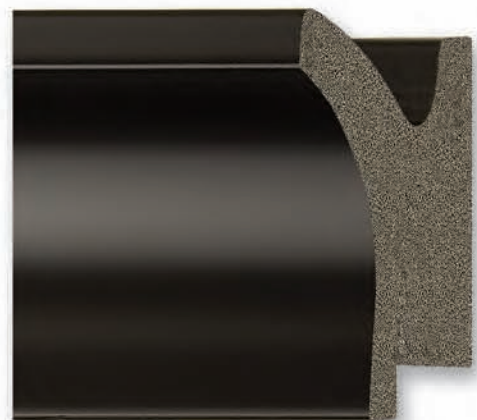

P83410



P83543



P80242



P83344



P80286



P83509



P83396



P83508



P83397



P83398





P83202



P83201



P83199



P83200



P83198



P83507



*Float* • P83191



P83189



P83195



P83196



P83190



P83188



P83193

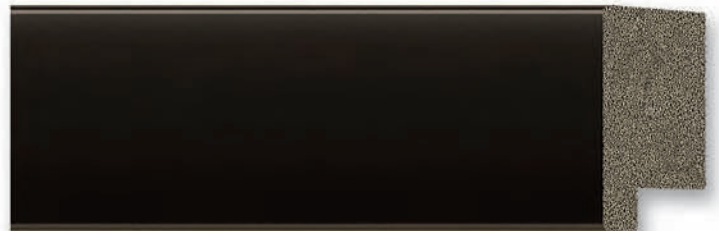

P83187



P83192

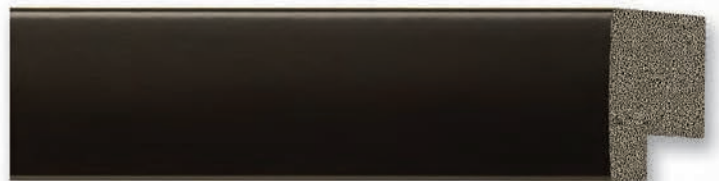

P83186



P83183



P83184



P83182



P83185



P83181



P83928



P83929



P83930



P83205



P83204



P83289



P83290



P83292



P83293



P83246



P83245



P83244



P83251



P83250

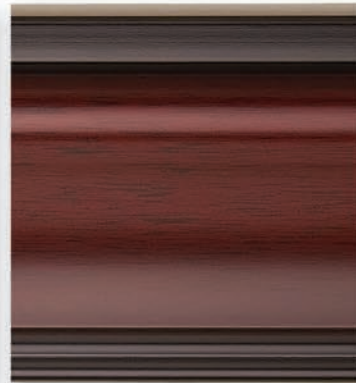

P83248



P83249



P83266



P83267



P83284



P83285



P83286



P83287





P83261



P83542



P83262



P83263



P83399



P83283



P83404



P80289



P80292



P83527

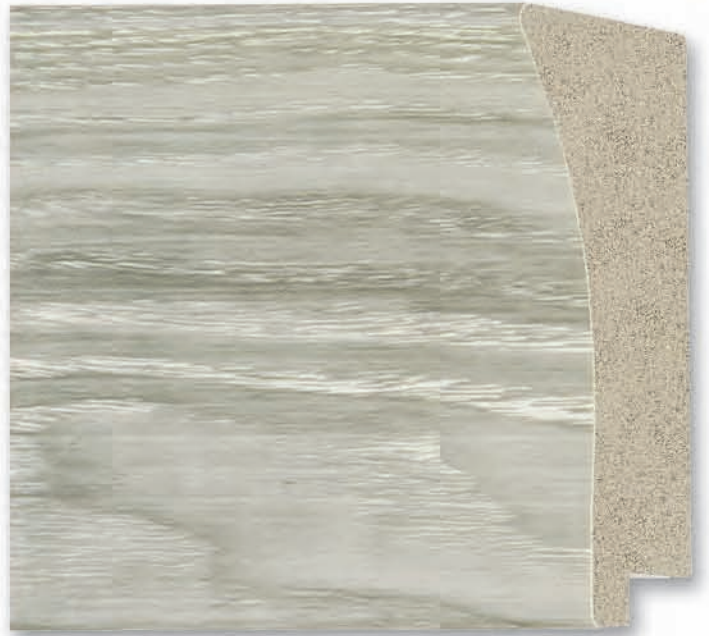

P83849



P83526



P83850



P83524



P83851



P83604



P83605



P83611



P83612



P83609



P83610



P83618



P83617



P83616



P83615



P83614

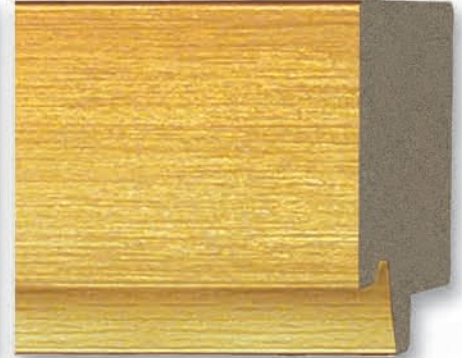

P83613



P83608



P83606



P83607

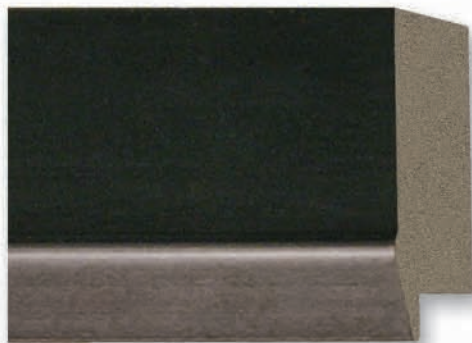

P83624



P83701



P83700



P83788



P83792



P83789



P83791



Floater • P83790



P83919



P83916



P83918



P83917



P83920



P83921



P83923



P83922



P83927



P83924



P83926



P83925



P83816



P83819



P83815



P83818



P83814



P83817





P83822

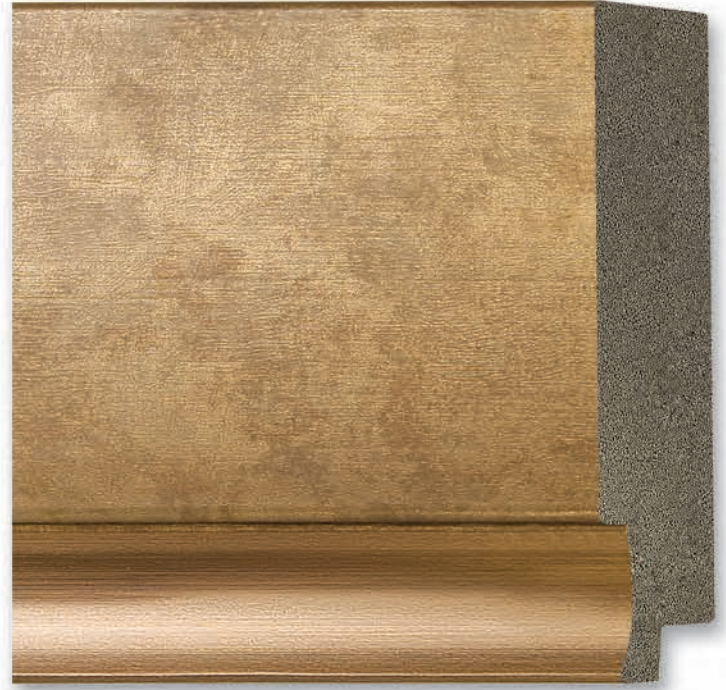

P83825



P83821



P83824



P83820



P83823

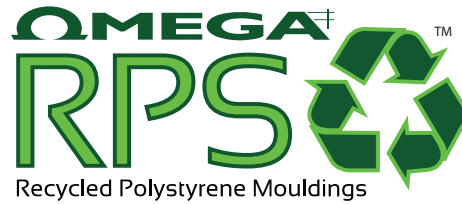

**Omega RPS** mouldings are manufactured from reclaimed, post consumer plastics that would have otherwise been placed in landfills. We are proud to offer a beautiful, recycled product that has a very long service life.

Your buyers and designers will appreciate that you can offer them greener picture framing solutions with Recycled Polystyrene Mouldings from Omega.





NEW MOULDINGS

---

2018-20



84049



84050



84048



84051



84052



84053



84064



84065



84066



84067

84060



84061



84062



84063



84089



84090



84091



*1 5/8" floater depth* 84092



84093 *1 5/8" floater depth*



84135

84136

84137

84132

84133

84134

84021

84022

84023

84027

84024

84028

84025

84026

84029

CALISTOGA

NEW





84121



84122



84125



84126

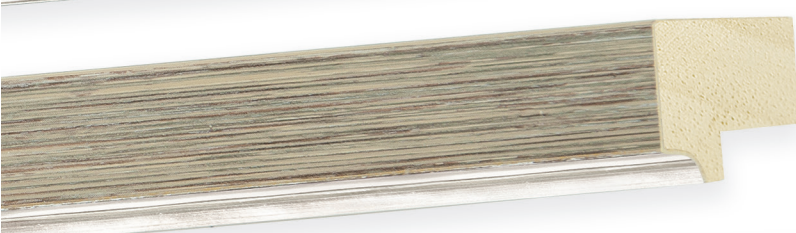

84127

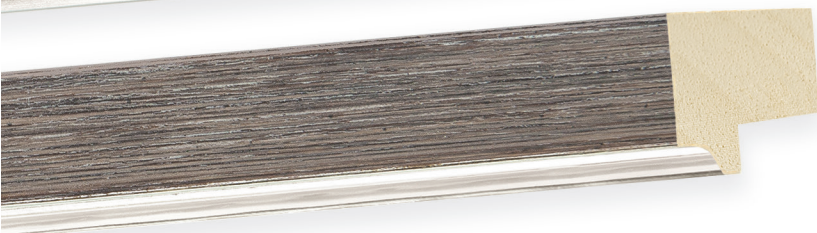

84128

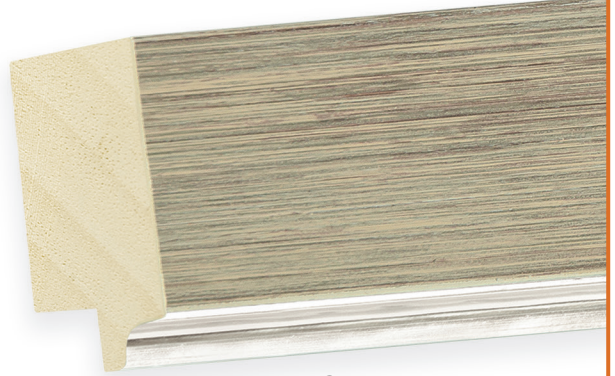

84123

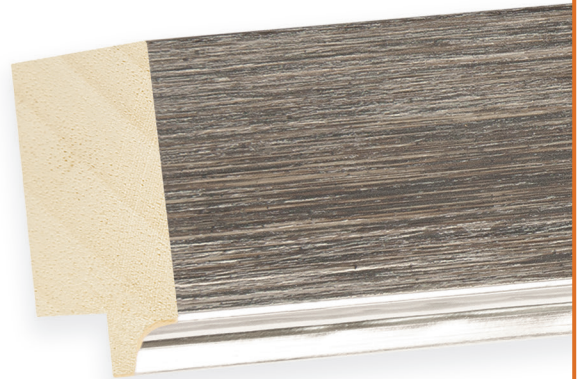

84124



84118

*1 3/8" floater depth*

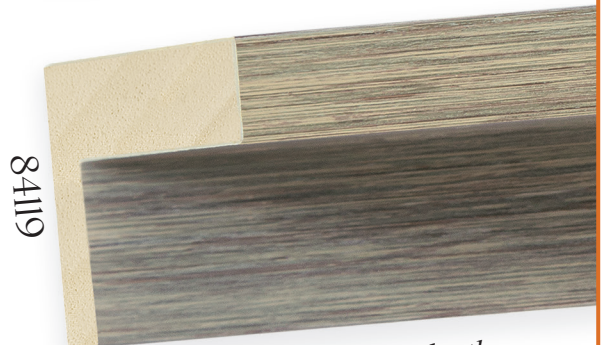

84119

*1 3/8" floater depth*



84120



83987



83988



83990



83989



83991



83992



83993



83994



83996

*1 1/2" floater depth*



83995

*1 1/2" floater depth*



84143



84144



84145



84138



84139



84140



84142

*1 1/2" floater depth*



84141

1 1/4" rabbet depth • 83903

1 1/4" rabbet depth • 83905

1 1/4" rabbet depth • 83904

83906

83908

83907

83909

83902

83948

1 1/4" rabbet depth

1 1/4" rabbet depth



83910

83912



83911



83913



84083



84084



84085



84086



84087

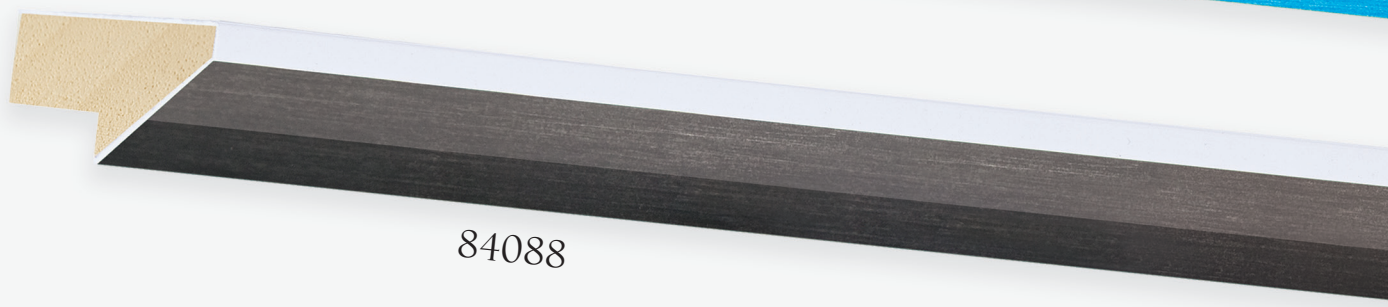

84088



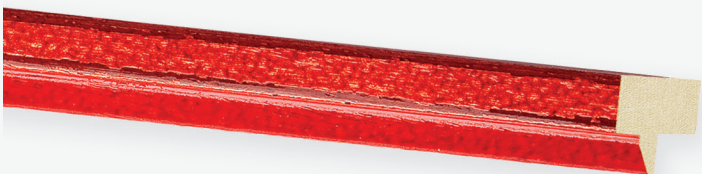

84030



84031



84032

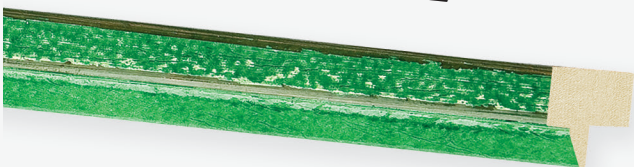

84033



84034



84035



84036



84037

84038



84039



84040



84041



84042



83949



83950



83953



83954



83951



83952



83955



83956

HIGH LINE

NEW



83934



83931



83935



83932



83936

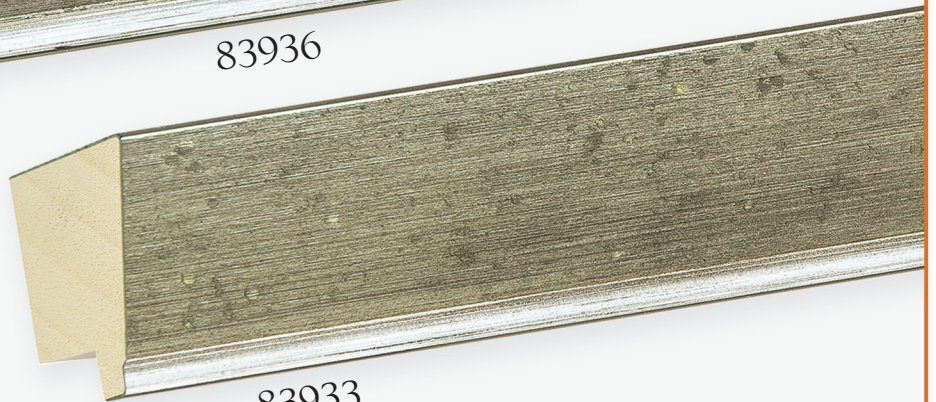

83933



83980



83981



83968



83976



83969



83978

PLATEAU

NEW



83970



83962

83979



83958



83977



83961





15/16" rabbet depth • 83959

15/16" rabbet depth • 83960

9/16" rabbet depth • 83957

83982

83984

15/16" floater depth

1" floater depth

3 5/8" shadowbox rabbet depth

83946

83947

E83854

E83857



*1 5/16" rabbet depth • 83937*



*1 5/16" rabbet depth • 83938*



83941



83942



83939

*1 5/16" rabbet depth*



83940

*1 5/16" rabbet depth*



83943



83944



84001



84002



84003



84004



84005



84006



84007



84008





83997



83998



83999



84000



*1 9/16" floater depth*

84009



84010



84011

*1 9/16" floater depth*



84012



84152



84153



84154



84155

84159



84160



84156



84157



84158



84161



84162



84146



84147



84148



84149



84150

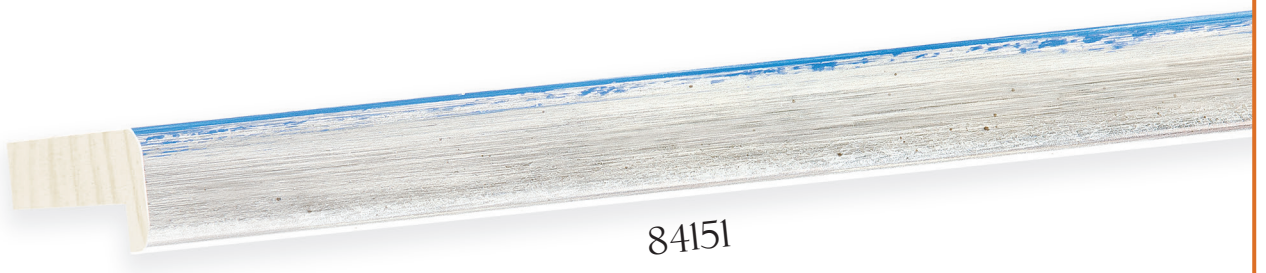

84151



84184



84182



84183 • 2" Shadowbox depth



84185



84180 • 1" Rabbet depth

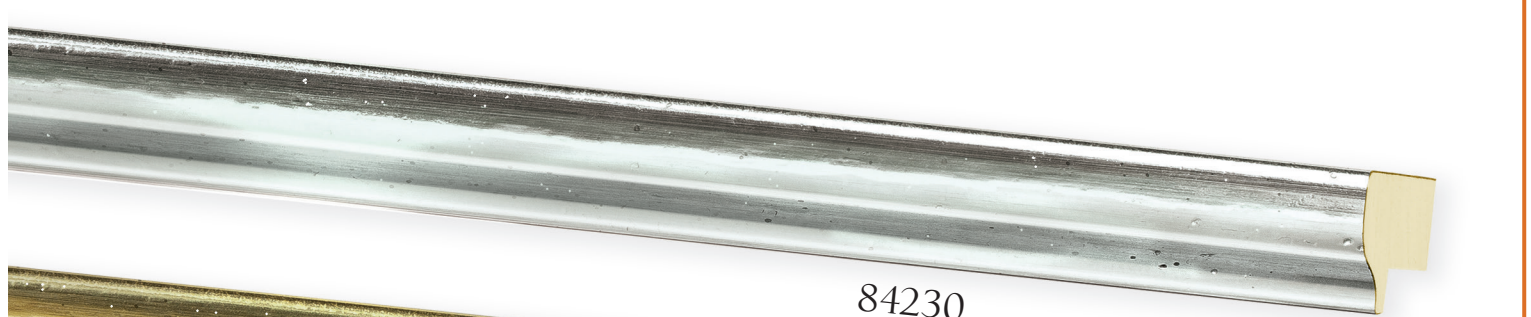

84230

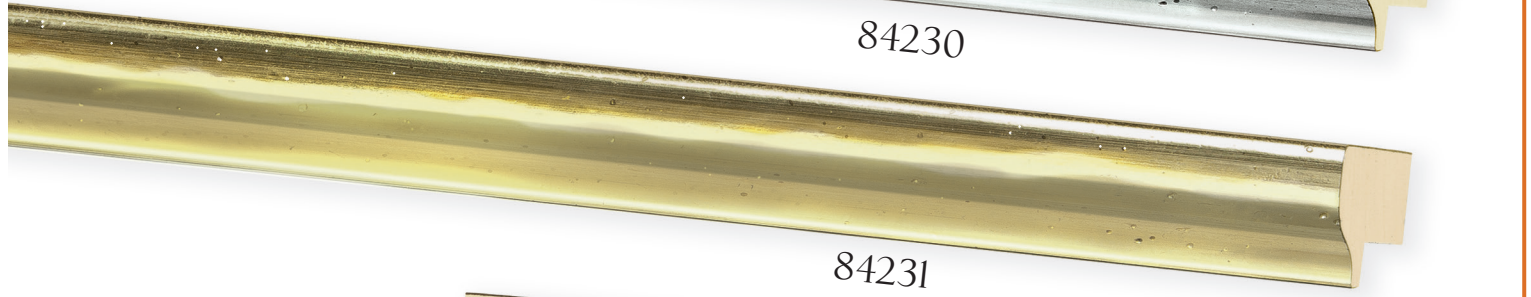

84231



84232

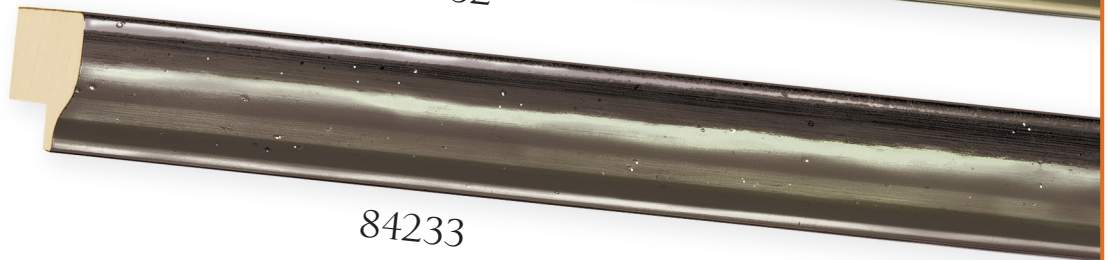

84233



84234



84235



84236



84237



84238



84163



84164



84165



84166

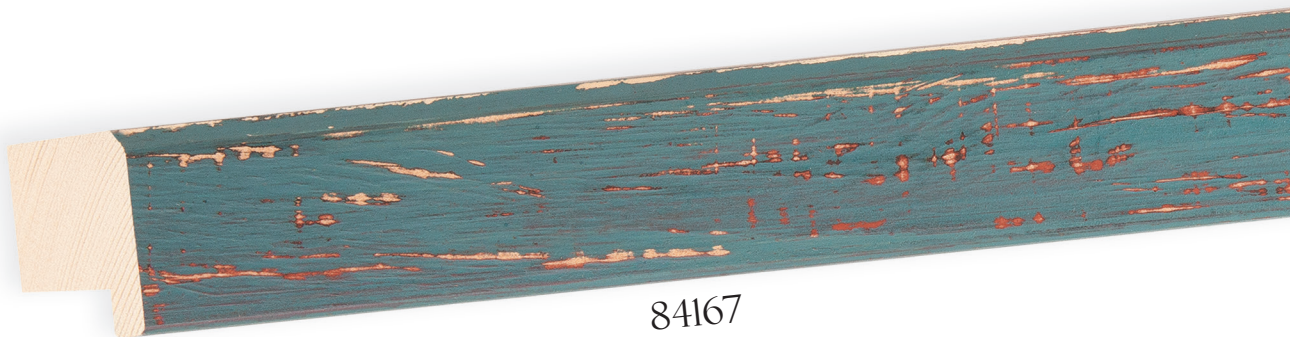

84167



84168



84190



84191

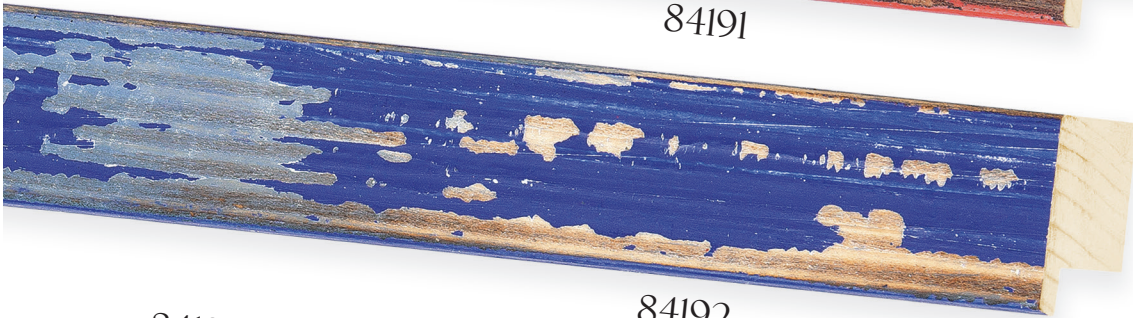

84192

84193



84194



84188



84187



84189

84178

84179

84174

84175

84176

84177



*New unfinished raw wood mouldings*

Stainable / Paintable • Premium Raw Ayous • Made in Italy



84072

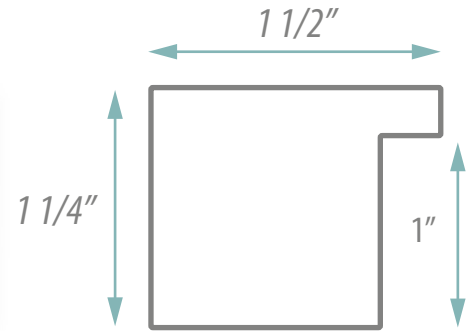

84073

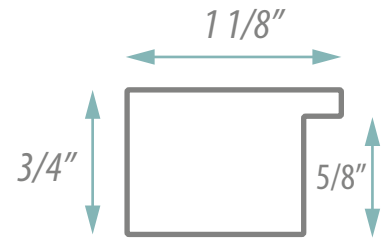

84074

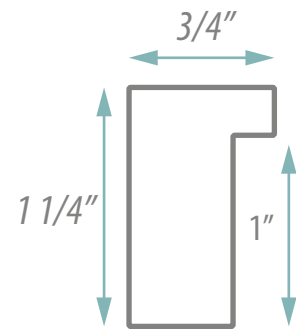

84075

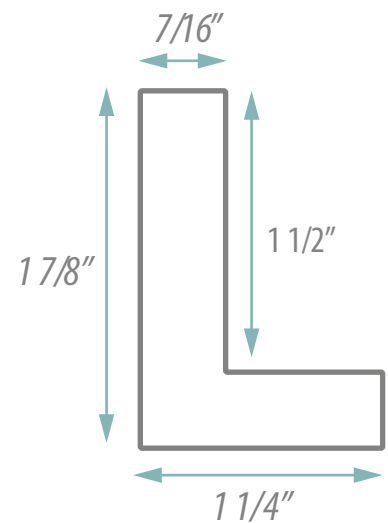

Stainable & Paintable

PUR

NEW

# FA

---

## Fine Art COLLECTION

We introduce the Fine Art Collection to satisfy an essential need for grand scale picture framing solutions for interior designers, gallery exhibitors, and purveyors of large format fine art.

This collection is hand crafted in Italy, utilizing a heritage of time-honored craftsmanship that is renowned with artists, furniture makers and designers worldwide. Exquisite wood and metal veneer finishes were selected and applied on substantial profiles to create both visual impact and elegance. The clean, simple lines of the profiles paired with the luster of metal and warm wood tones combine the elements of classic and modern, offering many framing solutions to a great variety of art and design genres and color schemes.

The Fine Art Collection was designed for those looking for visual impact. With the ultimate combination of scale and style, this group of mouldings will be an asset for those looking to give their art the grandest stage of all.

**OMEGA<sup>+</sup>**  
MOULDING COMPANY

# FINE ART

Collection

OMEGA<sup>+</sup>  
MOULDING COMPANY



MOULDINGS FOR LARGE FORMAT FINE ART



84117 • 3 1/8" dark olive overlap veneer



84116 • 3 1/8" medium olive overlap veneer



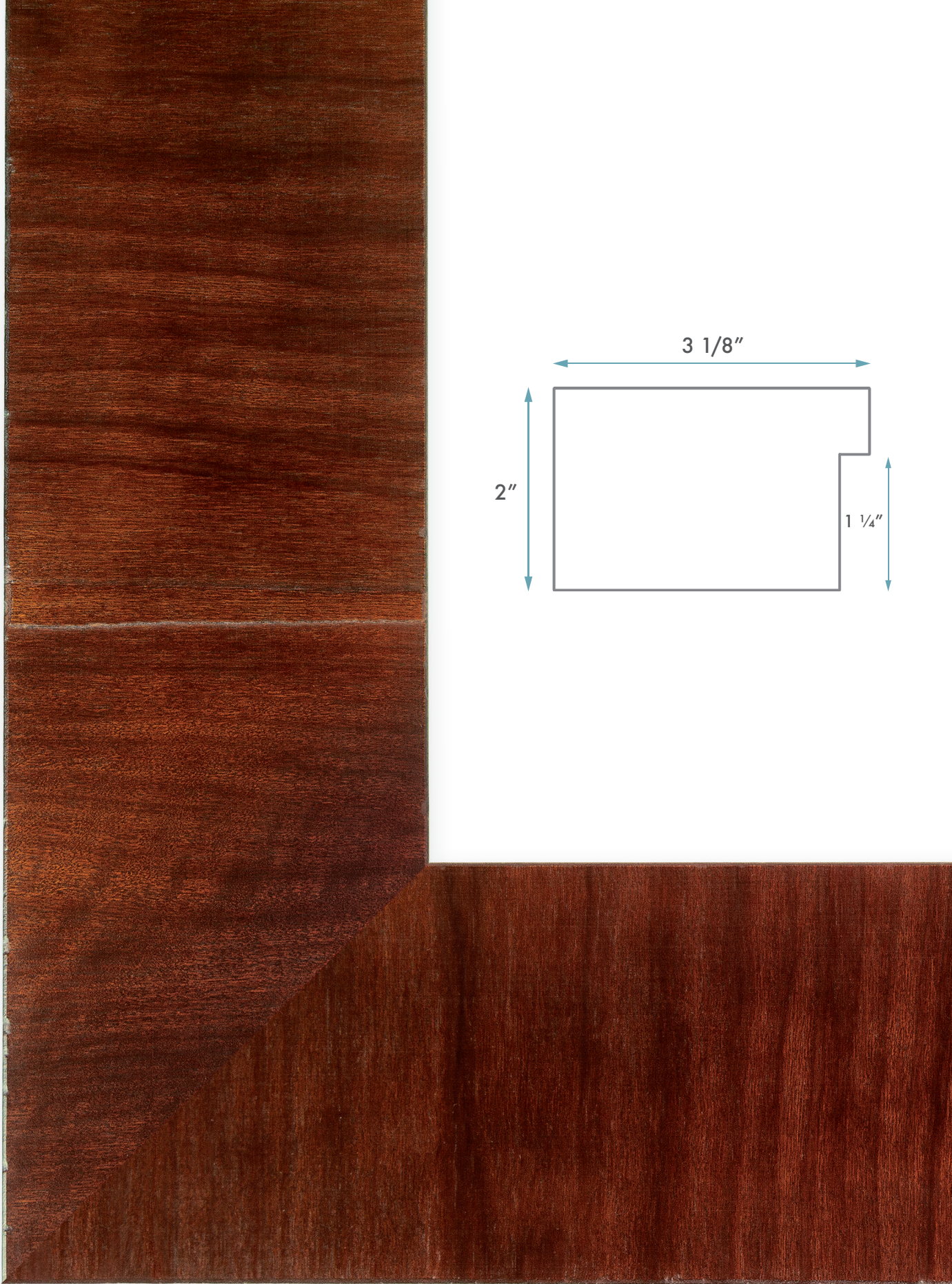

84115 • 3 1/8" light olive overlap veneer

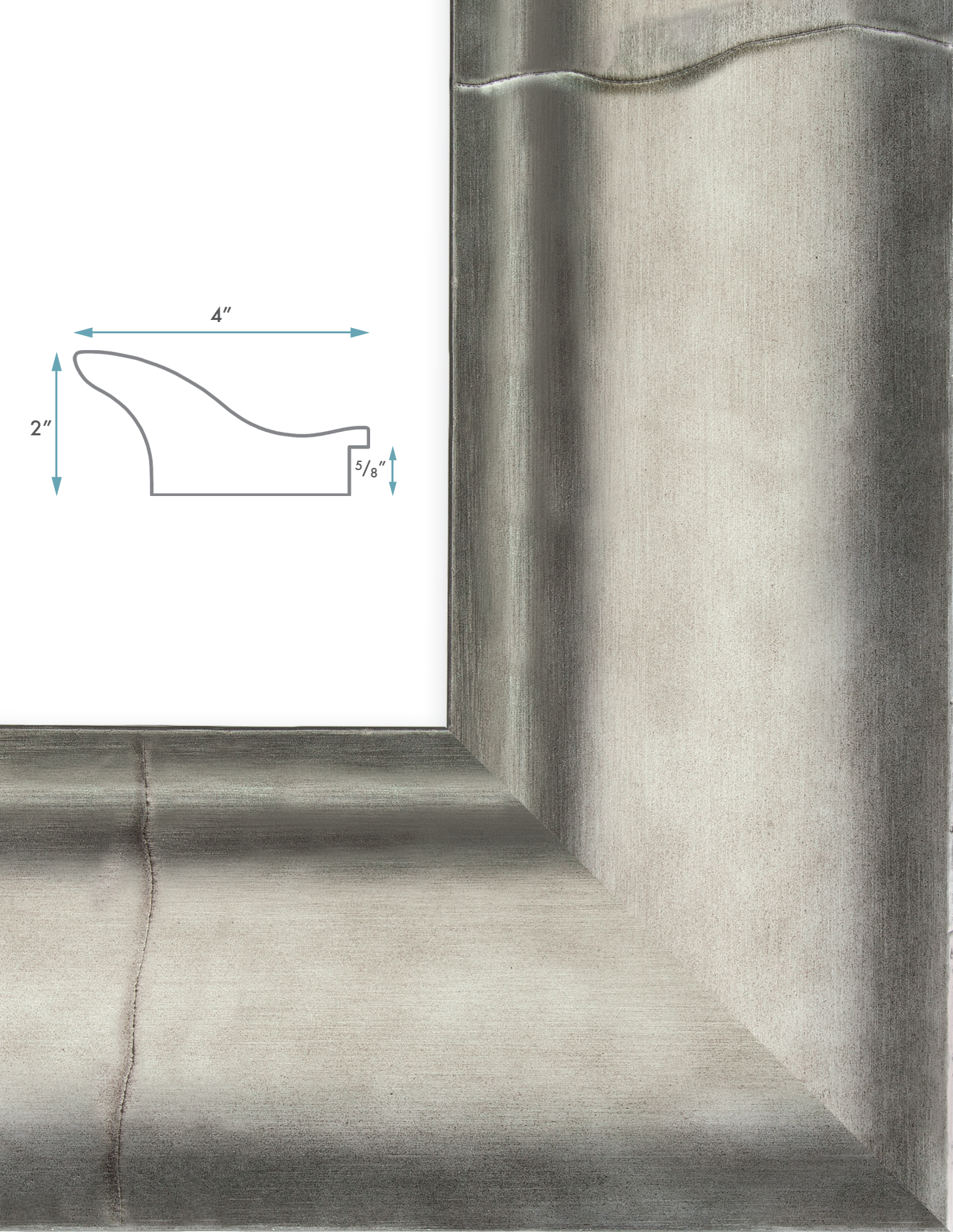
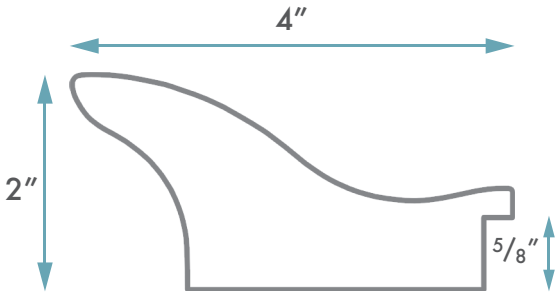

84107 • 4" light aluminum overlap veneer

(Top) 84109 • 4" medium daniela veneer  
(Bottom) 84110 • 4" dark daniela veneer



84108 • 4" medium aluminum overlap veneer



84112 • 2 5/8" medium aluminum overlap veneer



84111 • 2 5/8" light aluminum overlap veneer  
(1/2" rabbet)

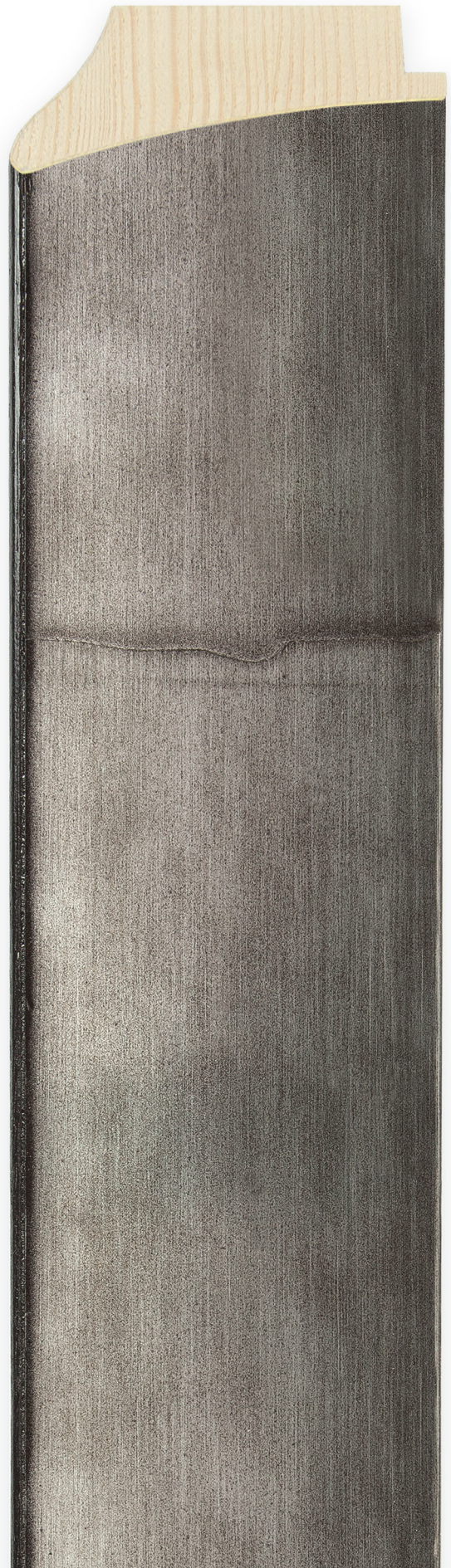



84114 • 3 1/8" medium aluminum veneer

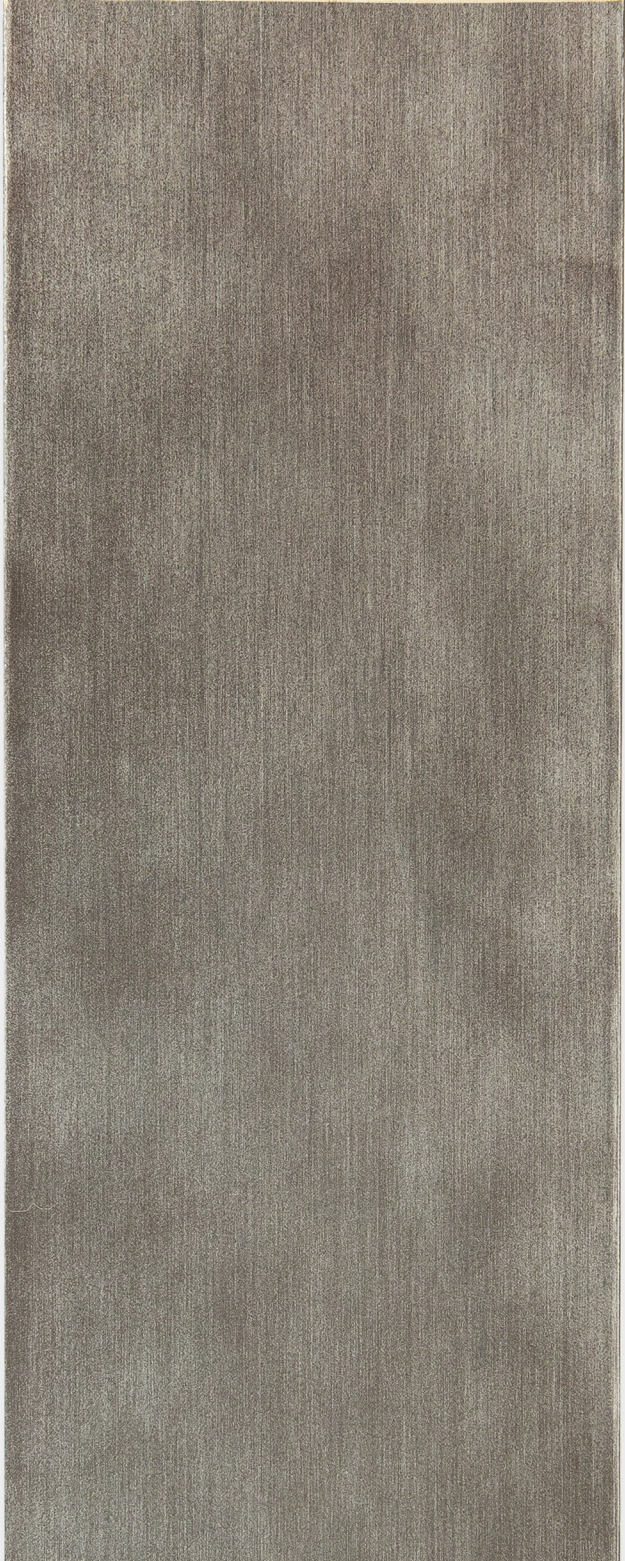

84113 • 3 1/8" light aluminum veneer  
(1 1/4" rabbet)

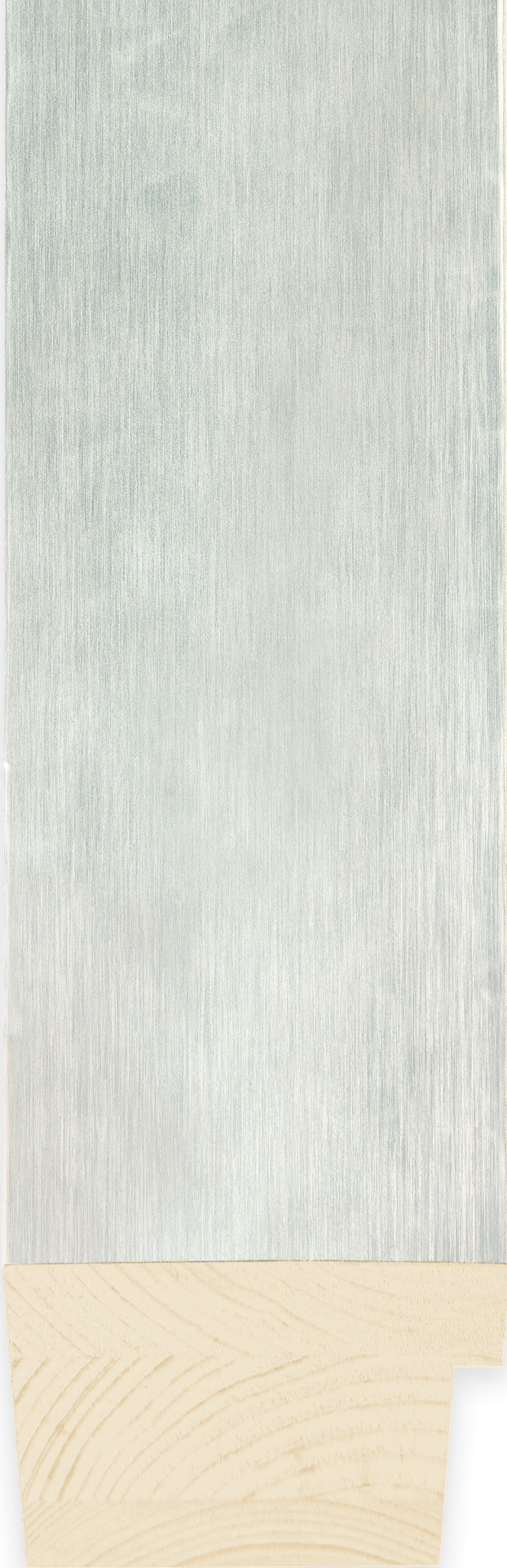



84113 • light aluminum veneer  
with white wash back edge

84114 • medium aluminum veneer  
with black stain back edge

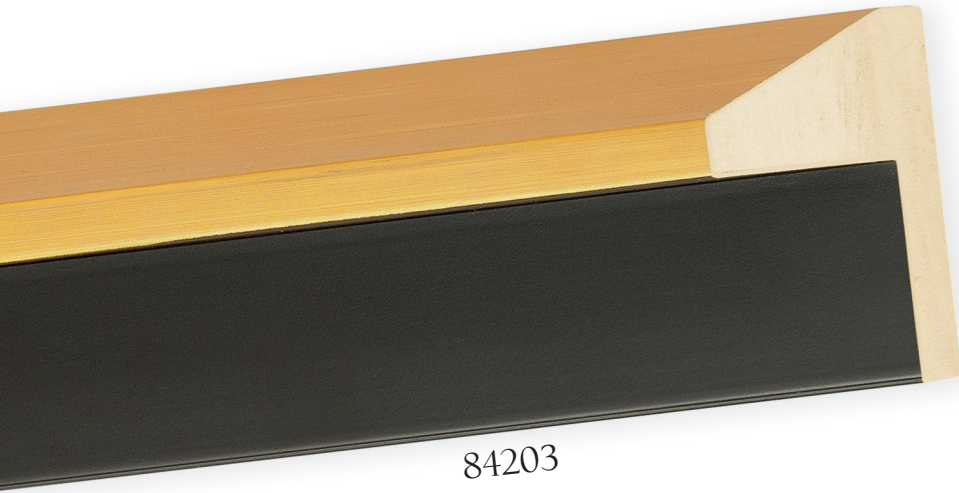

84203

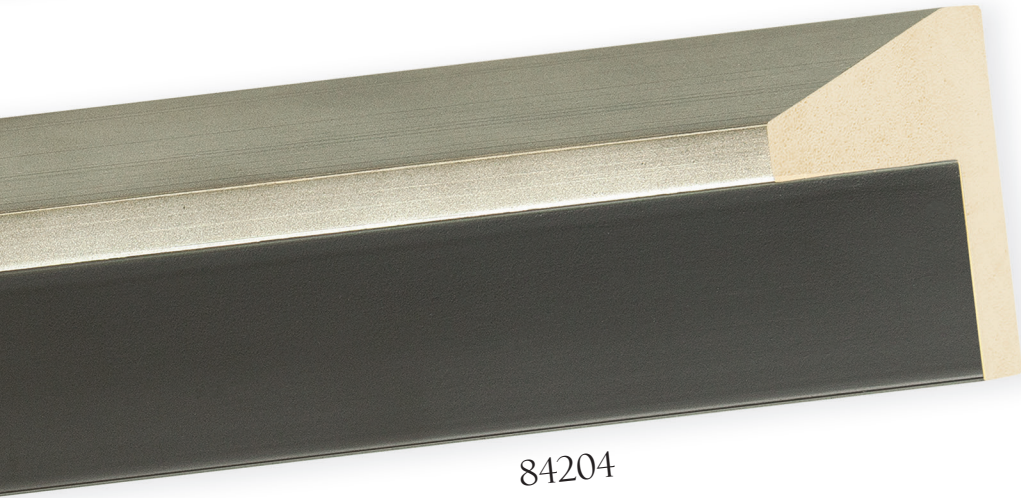

84204



84205



84206



84207

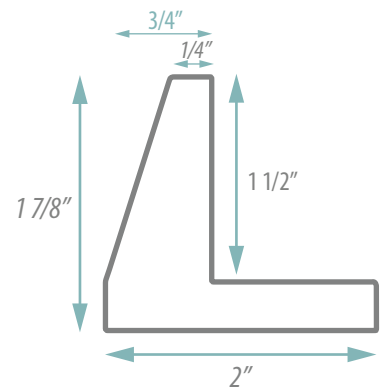

**OMEGA**  
ALPINE



84214

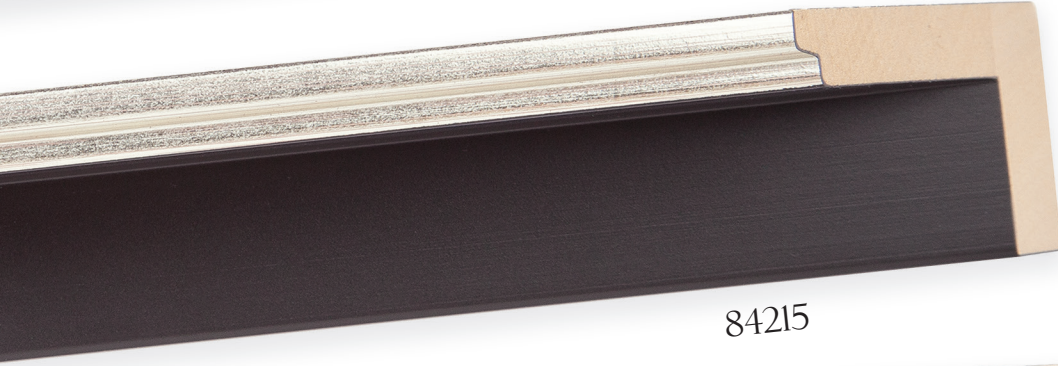

84215

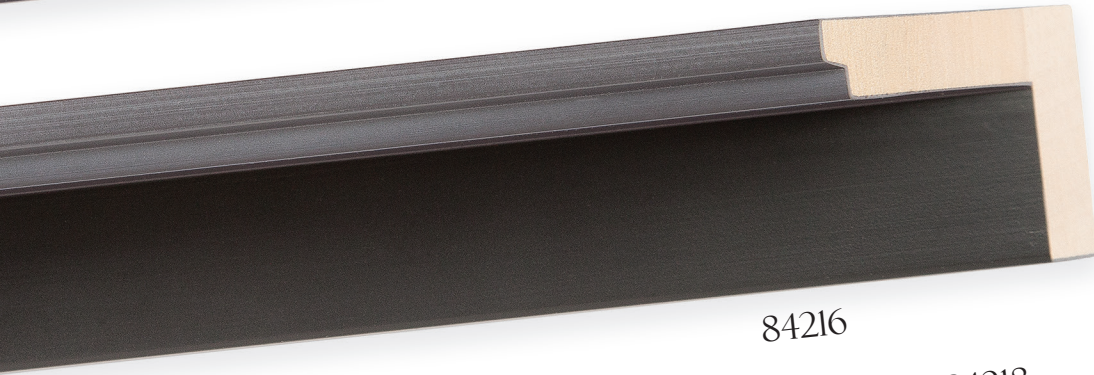

84216

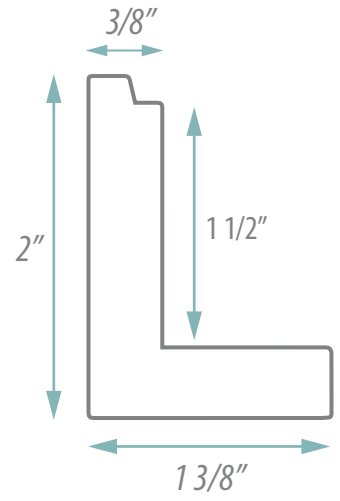

84217



84218



84219

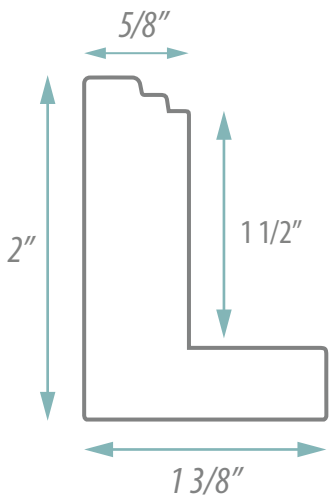



84208



84209

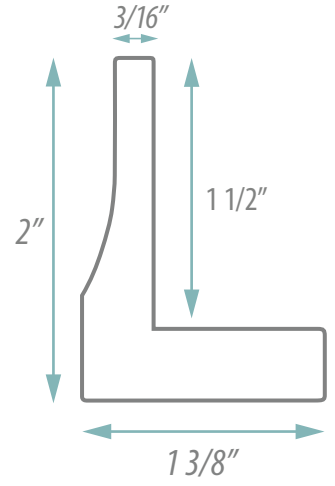

84212

84213



84210



84211

**ELEMENT**  
ΩMEGA



84070

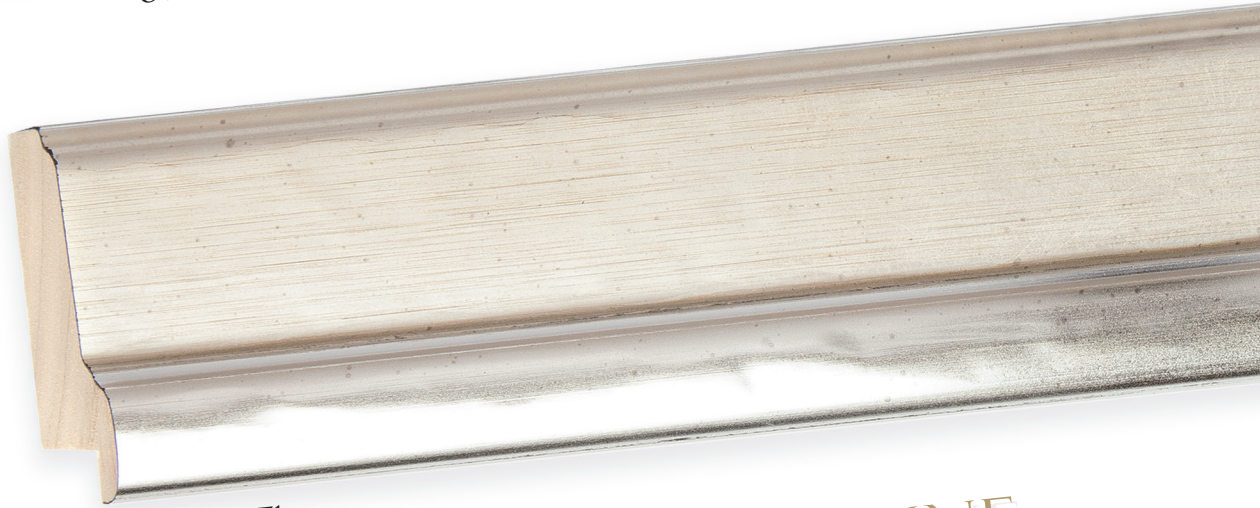

84071

Ω OMEGA ADRIENNE

84081



84082



84068

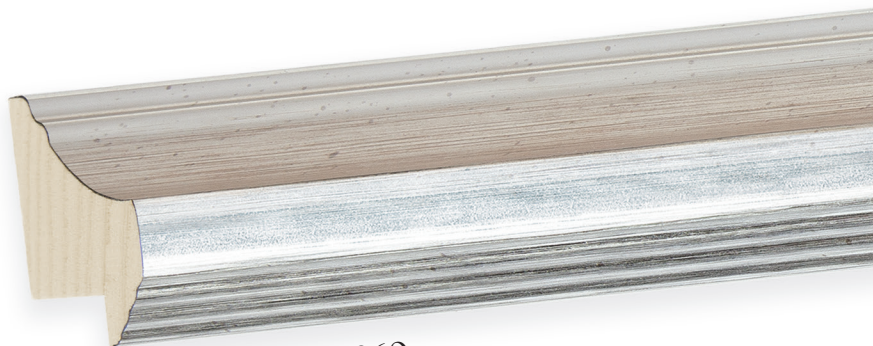

84069



84131



84130



84129

# ASPEN



84099



84100



84101



84102



84103

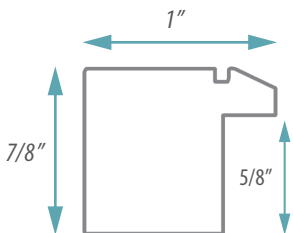





E84059



E84058



E84055



E84054



E84056



E84057



84045 • *Midnight* • 2" rabbet



84046 • *Bianca* • 2" rabbet



84047 • *Plateau* • 2" rabbet



83983 • *Essentials* • 1" floater depth



83985 • *Essentials* • 1 1/2" floater depth

SPECIAL ADDITIONS 2018

New Floaters & Shadowbox Mouldings

YORK



84250



84254



84252



84249

84253



84251



84255

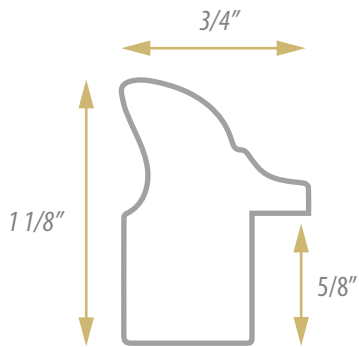

**OMEGA**<sup>+</sup>  
MOULDING COMPANY

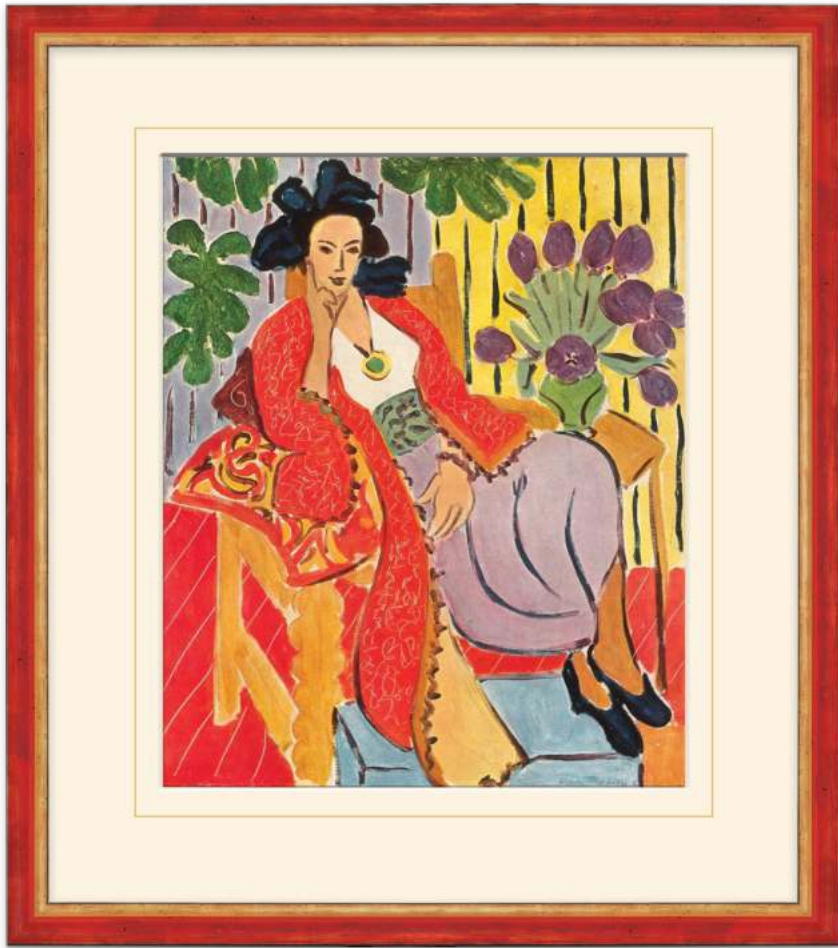

# YORK

*York features 7 items with a small traditional profile and clean lines that is simple but far from boring. Gold, silver and plum lead the pack for their universal appeal, while its remaining castmates boast some scene stealing attraction for those seeking a touch of something new.*

*Roman Red (84250) is bold and punchy and is sure to become an instant classic, providing eye-catching interest for art that demands attention. For more sophisticated looks, Baltic blue (84254), Slate (84252), and Black (84249) each feature a silver lip and bring life to a wide array of framing designs, as well as unifying collections and creating gallery wall compositions.*

*Each of the hand-applied finishes showcase the richness of layered color and gilding. Fine brush lines provide luster and depth, enhancing each color with sublime highlights upon the wax rubbed surface.*

*This collection is ideal for customers looking for petite profiles with an original take on classic charm.*

Art (left): **Odalisque with the Red Coat**, Henri Matisse c.1937



*The York Collection is handmade in Italy*

Art (below left): **The Son of Man**, Rene Magritte c.1964

Art (below right): **Bocca Rossa**, Piero Fornasetti c.1953



### △ Gallery Gems

The combination of York's profile size and color array make for creative compositions on gallery walls by unifying shape and size while giving us seven color choices for bespoke designs.

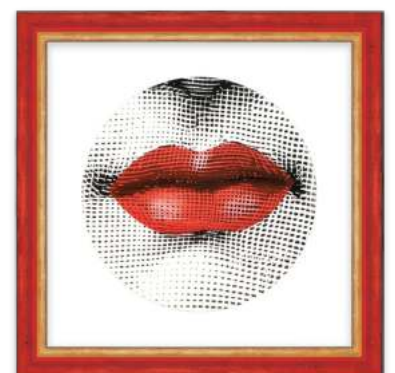

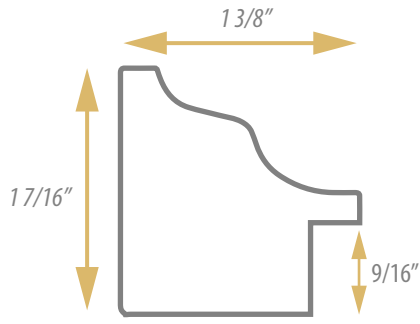

# EPOQUE



84267



84266



84265

84268

# EPOQUE

*Designed to impress with its textural contrast and technical virtuosity, the Epoque collection will appeal to fans of warmth and texture. The highly reflective ribbon scoop panel is nestled into a profile that surrounds the fascia with a tasteful wood grain texture.*

*This collection elegantly connects the outside natural world with the warmth and brightness of the metallic finishes. The finished product will elevate your customer's artwork to a high level while integrating seamlessly with the more natural tones of their interior.*

*Epoque's lines and finishes are ideal for projects that involve decorative art period genres of the 1900's such as art deco, art nouveau, and retro modern. The fluid texture, lustrous metals, and architectural lines bring forth a graceful modernity and glamour to interior spaces as well as complementing pieces with strong lines and decorative attributes. The collection pairs well with framing designs that employ unique matting designs such as multi-level creations, textural fabric surfaces, and painted lines.*

*The collection is bouyed by finishes in Gold (84268), bright Silver (84265), Champagne (84267), and oxidized Gunmetal (84266). Silver and Gunmetal finishes are reminiscent of mercury glass in different ages of patina.*



*The Epoque Collection is handmade in Italy*



△ Art (above): *Polyanthus*, Alphonse Mucha c.1899



## ◁ Organically Speaking

The curvy scalloped lines of Epoque's profile creates a stage for the organic silhouettes and geometric shapes seen throughout modern art in the last century. Epoque is a perfect collection to experiment with shape and light to create something totally unexpected.

◁ Art (left): *Superimposed Forms*, Jessica Dismorr c.1938

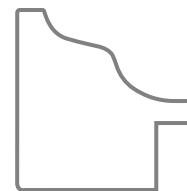



**PARKER**



84247



84248



84245



84246

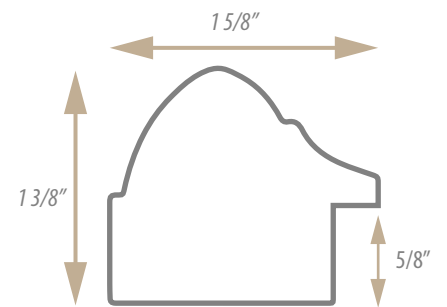

**ΩMEGA**<sup>+</sup>  
MOULDING COMPANY

# PARKER

The Parker Collection gives us two looks; a handsome traditional classic with warm furniture finishes, as well as Mid-Century modern elegance. This duality is well sought after in today's market, bridging traditional interior design motifs with more modern tastes in both art and home design. Art and home accessories play an important part in helping to fuse sleek modern home tech in our interior spaces with elements that are naturally more in tune with visual appeal and comfort.

Classics that can pull off modern will make Parker a new standard "go-to" for Picture Framers and designers alike. With the most popular trends in art and home decor staying consistent with these motifs, it delivers solutions for fine art (paintings, etchings, and drawings) to contemporary (photography, serigraphs, and graphic art.)

Parker is a great companion to **Carlyle** and **York** collection mouldings. Gold, silver, black and plum selections from each can be used together in a series, on the same wall, or combined in a single design.



△ Art (above): **Four Dancers**, Edgar Degas c.1899

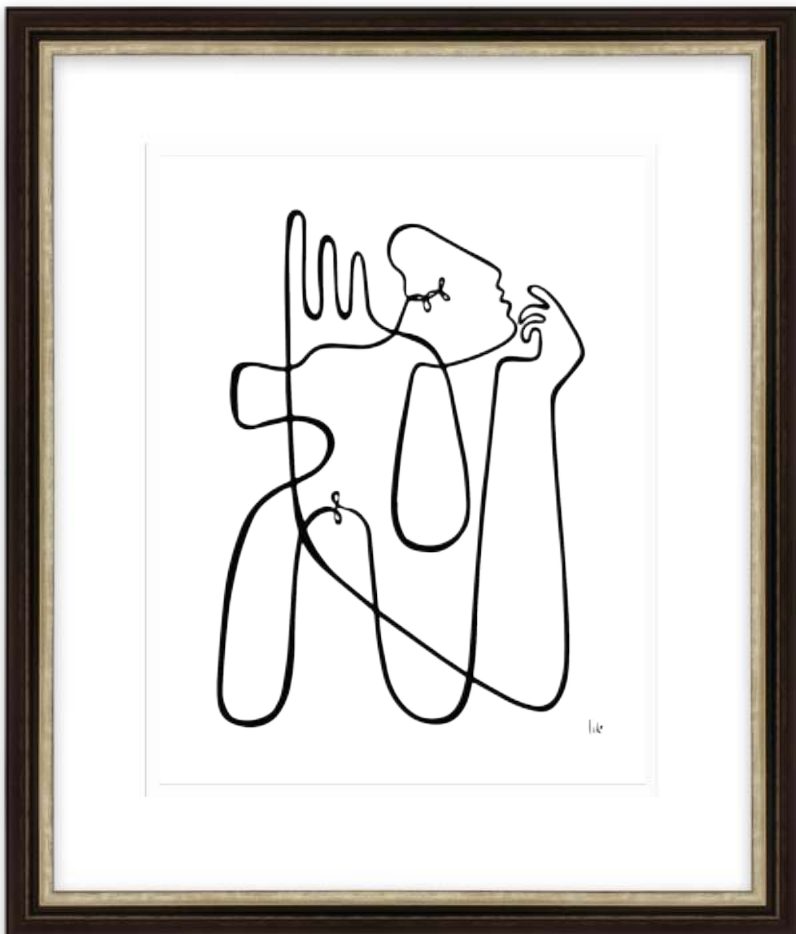

## ◁ Classic Example

By keeping it simple, a lot can be achieved in creating an undeniable winning combination that hits on style points and fits into multiple interior design settings. Staying with a clean design can be key to allow the artwork's beauty to take precedence. Scale is also important; Parker's 1 5/8" width can accommodate small and larger work both physically and visually.

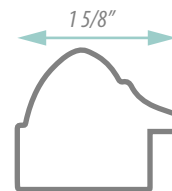

◁ Art (left): **No Gravity**, Lilo c.2022



The Parker Collection is handmade in Italy



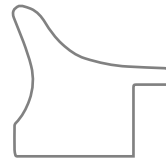

# Carlyle

1 1/8" scoop profile with 9/16" rabbet



84256

84257

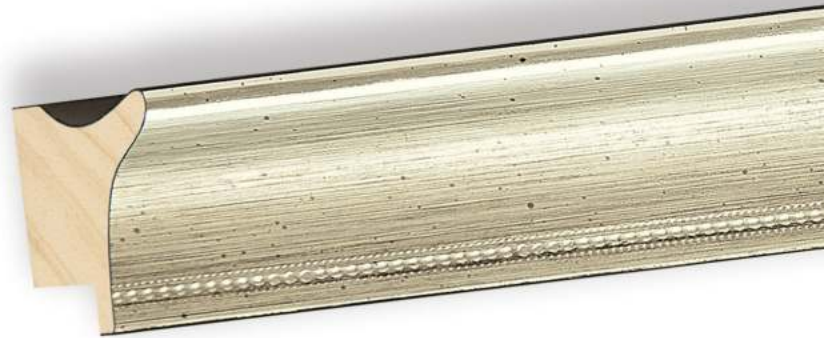

84259



84258



84260

# Carlyle

*Carlyle is a traditional profile with a modern twist. The luster and sparkle of modern gilding updates the look of the classic petite scoop adding a touch of sophistication. A delicate deboss is a contemporary treatment to the traditional beaded lip of classical mouldings of past eras. These subtle adjustments in design help streamline the overall look and convey a sense of fine workmanship.*

*The new styling allows the graceful scoop to be utilized on a wider range of artwork. The metallic finishes get a softer treatment, creating a lightness to the collection's palette in order to work with today's interior color schemes and art genres such as digital prints, illustration and color/black and white photography.*

*The collection can also be used to bridge styles within a setting where more traditional art and framing are present. Carlyle is naturally a lovely collection for collectibles, antiques, documents, drawings, etchings and fine art prints. Now, it can be shared with the art and home decor in today's market. Artists and designers will now have present-day classics at their disposal to create not only something new, but something that is timeless*



Art (right): *Silver Eye, The Bell Bird*, Walter Lawry Buller c.1888 >



*The Carlyle Collection is handmade in Italy*



## **Classically Photogenic**

At first glance, this collection may only seem traditional, but just look at what it can do for photography. What else can you use traditional profiles for? They call them classics for a reason.

# AVA



84282 1 3/8" reverse scoop • white & metallic brush with navy blue crest



84281 1 3/8" reverse scoop • white & metallic brush with silver crest



84280 1 3/8" reverse scoop • white & metallic brush with gold crest

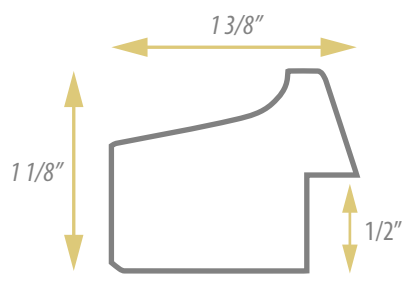

**ΩMEGA**  
MOULDING COMPANY

# AVA

*Ava is an elegant collection of three items that evokes a breezy coastal feel. The collection's aesthetic is designed to allow designers to introduce more sophisticated artwork into home settings with a clean tailored look, often seen in vacation homes.*

*Eternally popular coastal design, also known as 'beachy-chic', is recognized by the use of natural textures where materials such as rope, wicker, and driftwood are commonly employed within the setting. Shades of white, watery hues and white washed wood and fabrics are popularly used in the fabrication of furniture, home accessories and artwork.*

*Ava's white brushed finish carries the collection into this style category, setting the mood with a clean and airy sensibility. The brush lines are streaked with shimmering highlights that cast reflection from light to dark to deliver its textural dynamic. Accented on the crest with crisp gold (84280), silver (84281), and navy blue (84282); a nod to the nautical Ralph Lauren coastal home design palette popularized worldwide.*



The collection's bright white finish was selectively curated for its compatibility with modern digital printing papers.

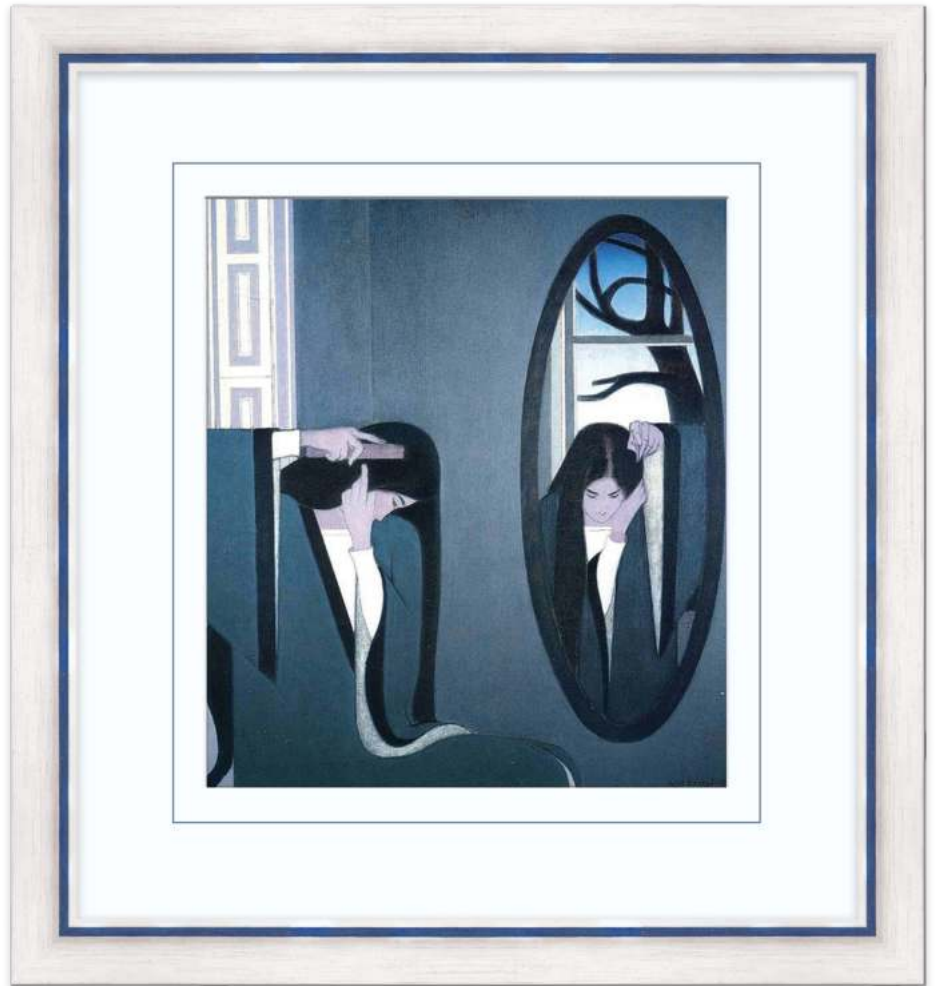

△ Art (above): *The Mirror*, Will Barnet c.1981



◁ Art (left): *Agave*, K. Nari c.2018



*The Ava Collection is handmade in Italy*

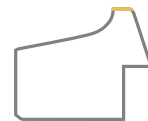

#### ◁ **Warm Tones, Cool Looks**

One shouldn't hesitate to use brushed white mouldings for only cool color pairings. Warm hues, jewel tones, and bolder saturated colors can be cooled down with the airiness of white. Here, the gold accent on 84280 can bring it all together, pulling out the earthy browns and sunny yellows while complementing the bright blue and greens.

# LOFT



84261



84262



84263

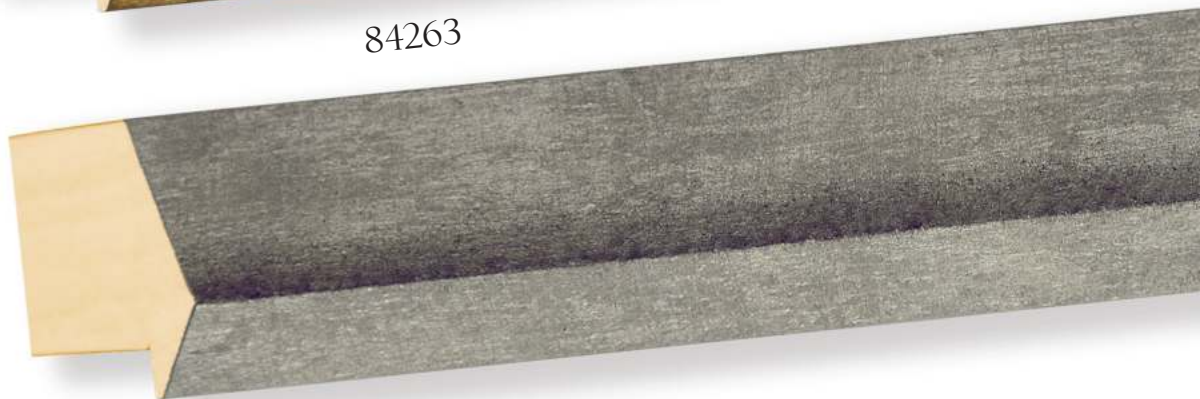

84264

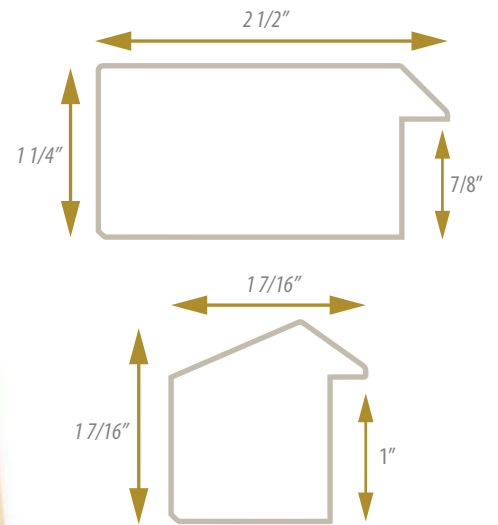

# LOFT

*Loft is a collection of pewter and gold items that have been toned and heavily textured to convey the look of raw, unrefined galvanized steel and bronze. This industrial look is produced to work with artwork and interior spaces in a variety of ways that enhance and reinforce characteristics within the aesthetics of each.*

*Industrial style focuses on the three components of strength, gravity, and architecture. The Loft Collection draws from these within its profile shape, colors, and proportion. Two geometric profiles were designed; the broad flat panel of 84261 (gold), and 84262 (pewter) are 2 1/2" wide and are ideal for large format framing as well as artwork that calls for bolder presentation. The second profile's sharp peak emphasizes the architectural lines a bit more in the 1 7/16" wide silhouette of 84263 (gold) and 84264 (pewter). The rough pitted metallic look gives the grouping its heavy feel, thus successfully uniting the elements to produce the intended design aspiration.*

*Loft mouldings are beautifully showcased on modern art pieces, exhibiting similar attributes of geometry, simple form and line, construction, abstraction, and dimension. Scale and size are also factored into designing with Loft. Large installation spaces can be magnificently outfitted by its bold architectural specs, making Loft great for hotels, galleries, showrooms, and open plan living spaces.*

Art (right): *Oli Sobre Fusta*, Ricard Tovar c.2021 ▷



*The Loft Collection is handmade in Italy*

## ◁ In Great Shape

Geometric shapes aren't always as strict and cold as you would think. Even though they almost work on everything, the hard edges can be too defined on mouldings with opaque finishes. With Loft, you can expand the field of possibility and be creative in utilizing the collection for watercolors and oil paintings, or any other art application or subject matter that has blended pigments, softer lines, or subtle details. By way of its texture and variegated appearance, it can be used as an elegant solution for those pieces you may yet to consider.

◁ Art (left): *Les Coureurs*, Robert Delaunay c.1920



# Volta



84271



84272



84269



84270



84273



84274

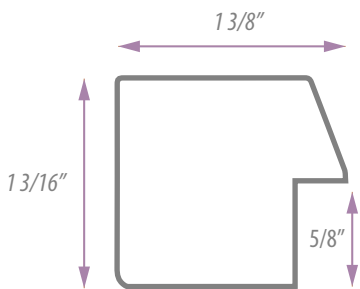

**OMEGA**<sup>+</sup>  
MOULDING COMPANY

# Volta

The Volta Collection is a neomodern collection, but it's timeless in that what you can design with it, is endless. Created to allow designers to produce elegant picture framing solutions, the collection uses soft muted hues that break away from neutral color schemes. This lends it to be used in a variety of interior environments as well as with more styles of art, as it blends warm and cool tones, and works simultaneously with both variegated and smooth textures. Geometric in shape, the profile can be easily integrated in modern and transitional interior design plans.

The overall look of Volta ranges from serene to dramatic. Softer subtle tones of silver in 84274 (fog grey), pewter in 84273, and champagne verdigris in 84271 (moss), invite the designer to explore more within the neutral palette. Meanwhile, the colorful contrast of 84269 (charcoal) uses black, copper, and oxidized silver; 84272 (blue) employs a color story of blues and violet upon gold, copper and pewter. Even gold, in 84270, (dark sand) is a visual treat surely to be used in any stretch of the imagination.

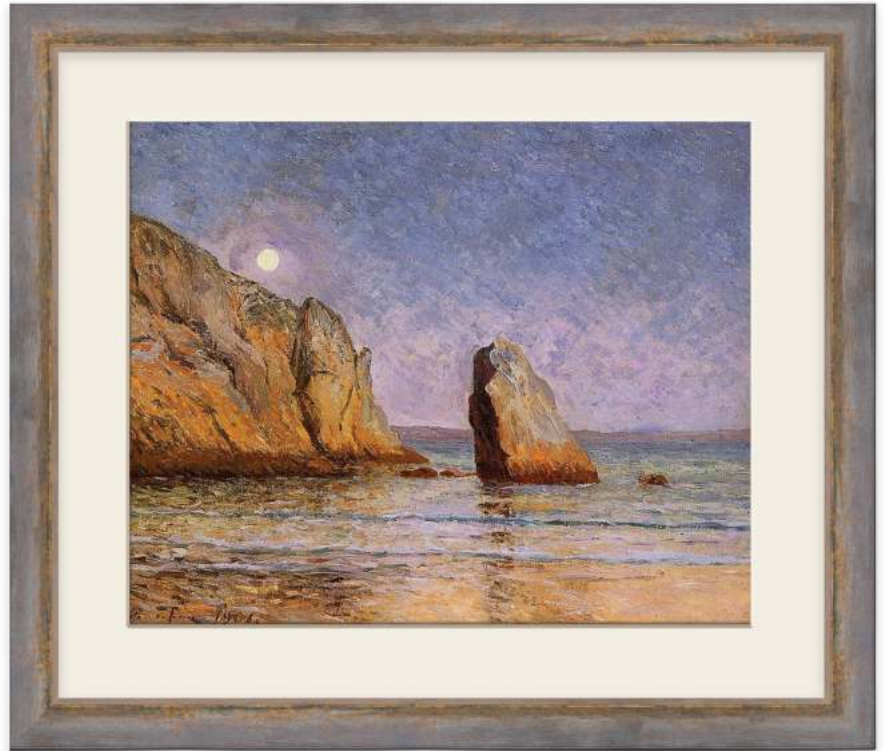

△ Art (above): *Moonrise*, Maxime Maufra c.1901



*The Volta Collection is handmade in Italy*

## ◁ A Finer Blend

With an attractive variety of color hues, textural tones and tinted metal patinas, Volta's unique mix of attributes works well on art from different eras. From the layered softness of impressionism (above), to more graphic illustrative work (left), this collection will inspire one's creative side to emphasize desired colors and details in the artwork that will elevate each piece to treasured status.



*The beveled nose surrounding the artwork is gilded, creating a brightly edged border that helps to draw the viewer's focus toward the subject.*

◁ Art (above): *Setting Intentions*, Duy Huynh c.2014





84276



84277

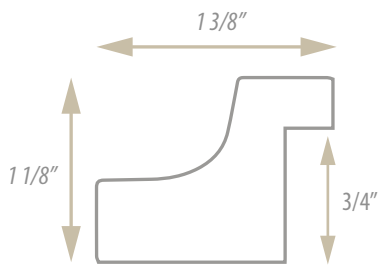

84278



84275



84279

**Gio**  
**ΩMEGA**



# Gio

The Gio Collection is a colorful and whimsical collection of five items that is truly transitional and dynamic. Soft metal patinas are featured, creating contrasts and interesting plays of shadow and light. There are numerous tonal subtleties within each finish, allowing a designer to try multiple samples within this collection for the same piece, all depending on the eye of the beholder. A deep reverse swan profile leads to a flat cap top that creates a reflective plateau surrounding the artwork.

Gio's overall aesthetic is tranquil and refined but can be used for dramatic effect when creativity strikes. Light and ethereal 84275 (white-silver), and 84278 (slate-violet), are brilliant and soft, appealing for designing with pastel color palettes and impressionist style works. A blend of warm and cool is displayed on 84276 (beige-silver) with a terracotta weathered finish on silver. The earthy contrasts of 84277 (brown-gold) is more dramatic as is the stunning 84279 (black-gold). This collection is sure to be a favorite for designers who have an eye for the unique.

Art (right): *Breaking The Cycle*, Duy Huynh c.2020 ▷



The Gio Collection is handmade in Italy

## ◁ Multi-Use, Multi-Hues

While designing with Gio, one must know ahead of time to "expect the unexpected." There's something about those hues and reflections that makes one try them all. Whether you intend to be imaginative or practical, you'll find yourself in full designer mode. The finish is somewhat reminiscent of Venetian plaster or fresco where, depending on the light, can cast a different color on second glance. This will lead to innovative color decisions on mat board choices and for the more creative-minded, you will express your design skills to the fullest.

☆ Gio is a nice companion to the Volta Collection.

◁ Art (left): *Anemone*, William Morris c.1876

# GEHRY

**OMEGA**<sup>+</sup>  
MOULDING COMPANY

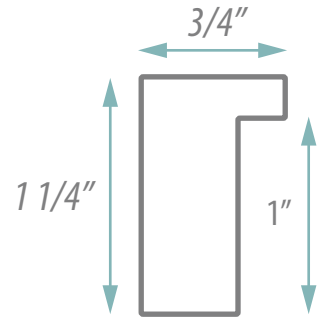

84283

84284



84287

84285

84286

**TRENDSETTER**  
TrendSetter Program Collection

# GEHRY

*Gehry is a classic modern collection with an industrial aesthetic, rendered in the textural complexity of grinded metal on a geometric profile. Plays of light are produced in the radial swirls and streaks and is the star of the show, introducing a new and unique finish for picture framing artwork in a variety of interior design schemes.*

*Five finishes equally showcase the coolness and warmth of metal; silver (84283), champagne (84284), and pewter (84285) are beautiful accompaniments to black and white photography, etchings, graphic art, and art with neutral tones. Copper (84286) and gold (84287) bring life to more colorful media and modern art, color photography, lithographs, and watercolors, as well as transitioning many genres of art into a single design theme, such as gallery walls, and framing art collections. Gehry's 1" rabbet allows for framing works on canvas and dimensional work requiring spacer and shadow box applications.*

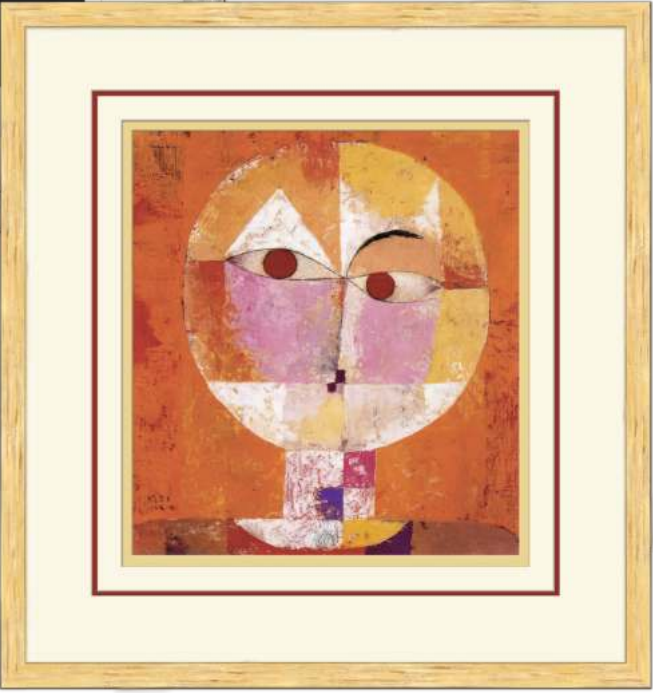

- △ Art (Top left):  
**Butterfly** (pigment photograph)  
Mark Shaw, c.1950
- ◁ Art (left):  
**Senecio**  
Paul Klee, c.1922



The Gehry Collection is handmade in Italy

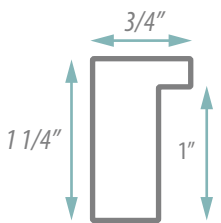

Walt Disney Concert Hall · Los Angeles, California



◁ **Brightly Inspired**  
The Gehry collection pays homage to the beautiful polished steel architecture of Frank Gehry and the appealing brilliance of grinded metal artwork.



**P83974** 2" • Mocha w/ silver lip (5/8" Rabbet Depth)



**P83972** 1 5/8" • Mocha square (7/8" Rabbet Depth)

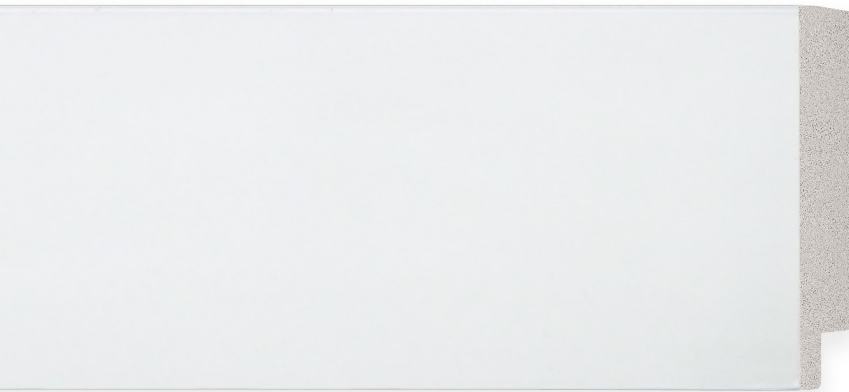

**P84171** 2" • Matte White (3/8" Rabbet Depth)



**P84172** Matte White floater (1 7/8" floater depth)

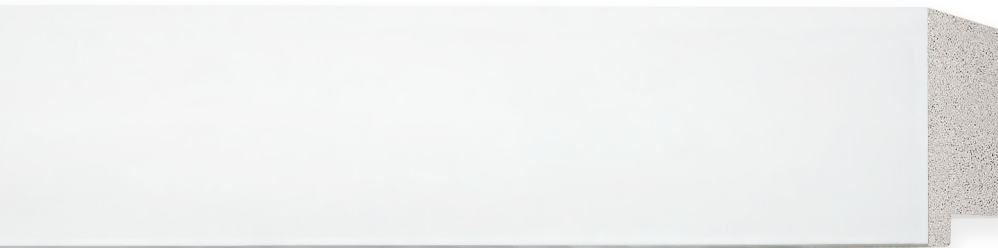

**P84170** 1 1/4" • Matte White (5/8" Rabbet Depth)

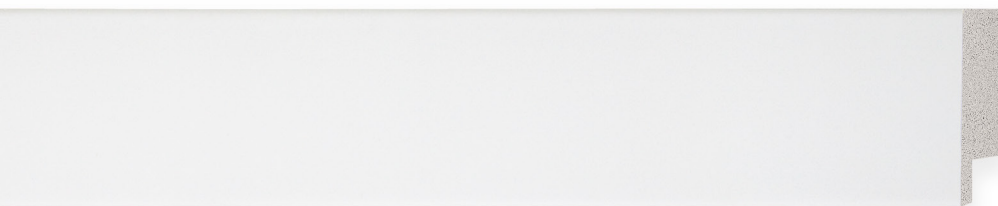

**P84169** 1" • Matte White (1/2" Rabbet Depth)



**P84173** Matte White floater (1" floater depth)

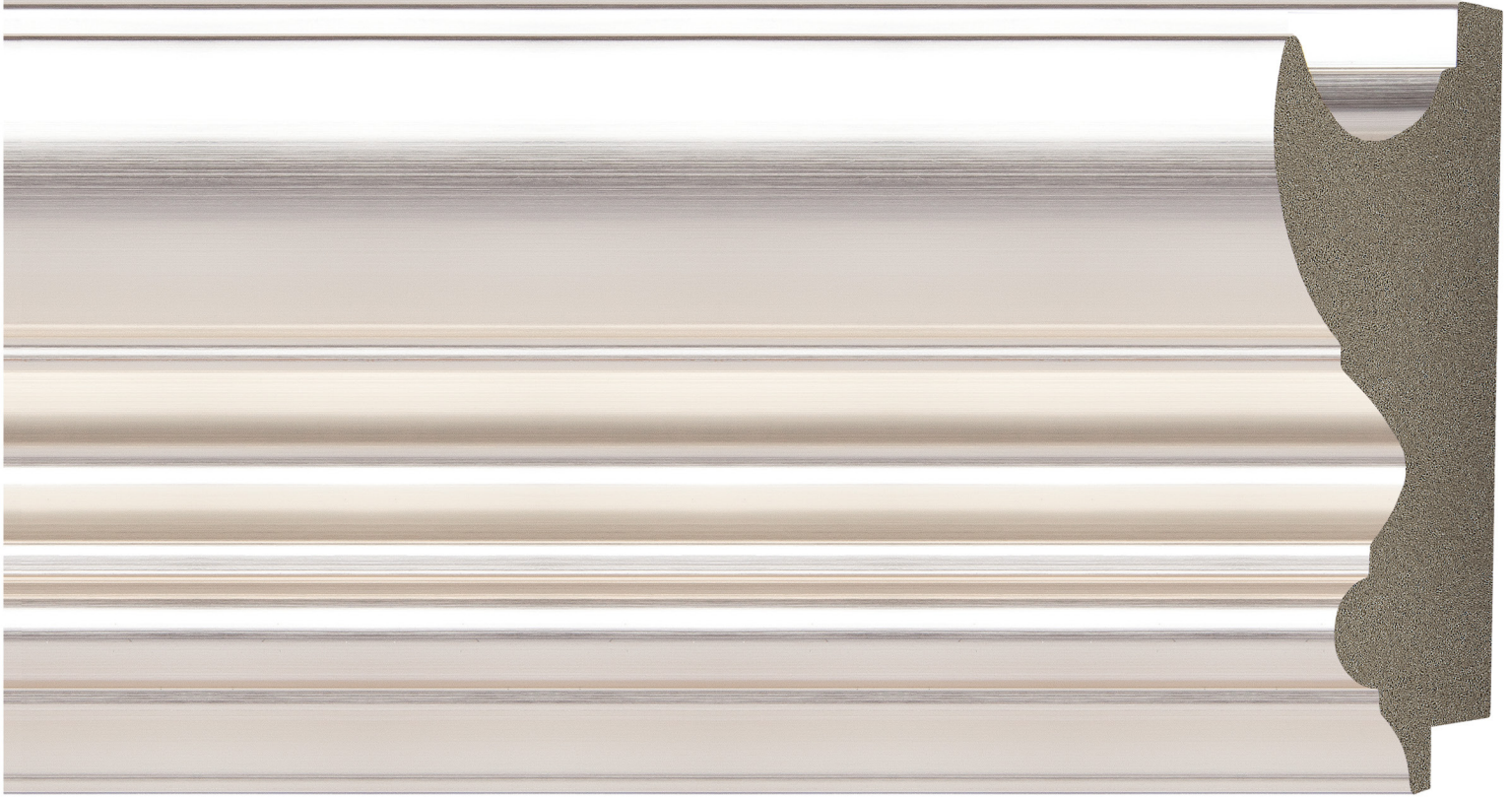

**P84106** 4 1/4" • Silver Gloss (9/16" Rabbet Depth)



**P84105** 4 1/4" • Black Gloss (9/16" Rabbet Depth)



**P84104** 4 1/4" • White Gloss (9/16" Rabbet Depth)



**P84288** 1" • silver square (11/16" rabbet depth)



**P84289** 1" • champagne square (11/16" rabbet depth)



**P84290** 1" • bronze square (11/16" rabbet depth)



**P84291**

1" • gold square (11/16" rabbet depth)



**P84292**

1" • silver square (11/16" rabbet depth)

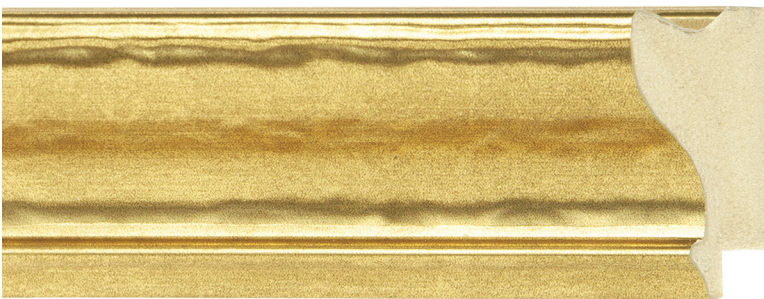

**P84293** 1 9/16" • gold hammered scoop (3/8" rabbet)



**P84295** 1 9/16" • champagne scoop (3/8" rabbet)

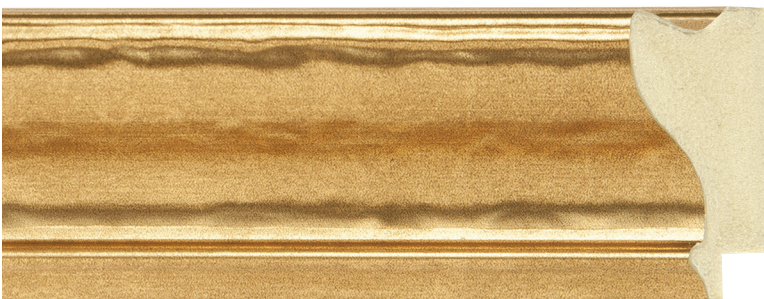

**P84294** 1 9/16" • bronze hammered scoop (3/8" rabbet)

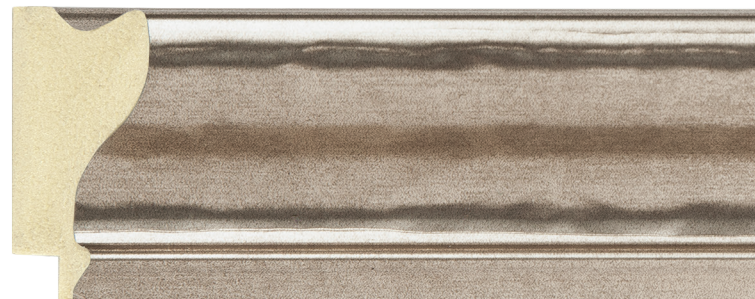

**P84296** 1 9/16" • platinum scoop (3/8" rabbet)



**P84301** 1 9/16" • gold scoop (3/8" rabbet depth)



**P84302** 1 9/16" • silver scoop (3/8" rabbet depth)

## New Polystyrene Mouldings

Polystyrene Mouldings manufactured from recycled post-consumer plastics



1 3/16" • gold hammered scoop (1/2" rabbet depth)

**P84297**



1 3/16" • silver hammered scoop (1/2" rabbet depth)

**P84298**



**P84299** 1 7/8" • gold deep scoop (1/2" rabbet)



**P84300** 1 7/8" • silver deep scoop (1/2" rabbet)



**P84303** 2 1/8" • gold panel w/ high back (9/16" rabbet depth)



**P84304** 2 1/8" • silver panel w/ high back (9/16" rabbet depth)

